



BASS AMPLIFIER

BBT500H

Owner's Manual

Mode d'emploi

Bedienungsanleitung

Manual del Usuario

Manuale di Istruzioni

Handleiding



FCC INFORMATION (U.S.A.)

1. IMPORTANT NOTICE: DO NOT MODIFY THIS UNIT!

This product, when installed as indicated in the instructions contained in this manual, meets FCC requirements. Modifications not expressly approved by Yamaha may void your authority, granted by the FCC, to use the product.

2. IMPORTANT:

When connecting this product to accessories and/or another product use only high quality shielded cables. Cable/s supplied with this product MUST be used. Follow all installation instructions. Failure to follow instructions could void your FCC authorization to use this product in the USA.

3. NOTE:

This product has been tested and found to comply with the requirements listed in FCC Regulations, Part 15 for Class "B" digital devices. Compliance with these requirements provides a reasonable level of assurance that your use of this product in a residential environment will not result in harmful interference with other electronic devices. This equipment generates/uses radio frequencies and, if not installed and used according to the instructions found in the users manual, may cause interference harmful to the operation of other electronic devices. Compliance with FCC regula-

tions does not guarantee that interference will not occur in all installations. If this product is found to be the source of interference, which can be determined by turning the unit "OFF" and "ON", please try to eliminate the problem by using one of the following measures:

Relocate either this product or the device that is being affected by the interference.

Utilize power outlets that are on different branch (circuit breaker or fuse) circuits or install AC line filter/s.

In the case of radio or TV interference, relocate/reorient the antenna. If the antenna lead-in is 300 ohm ribbon lead, change the lead-in to co-axial type cable.

If these corrective measures do not produce satisfactory results, please contact the local retailer authorized to distribute this type of product. If you can not locate the appropriate retailer, please contact Yamaha Corporation of America, Electronic Service Division, 6600 Orangethorpe Ave, Buena Park, CA90620

The above statements apply ONLY to those products distributed by Yamaha Corporation of America or its subsidiaries.

* This applies only to products distributed by YAMAHA CORPORATION OF AMERICA.

CANADA

This Class B digital apparatus complies with Canadian ICES-003.

Cet appareil numérique de la classe B est conforme à la norme NMB-003 du Canada.

- This applies only to products distributed by Yamaha Canada Music Ltd.
- Ceci ne s'applique qu'aux produits distribués par Yamaha Canada Musique Ltée.

IMPORTANT NOTICE FOR THE UNITED KINGDOM

Connecting the Plug and Cord

WARNING: THIS APPARATUS MUST BE EARTHED
IMPORTANT. The wires in this mains lead are coloured in accordance with the following code:

| | |
|------------------|-----------|
| GREEN-AND-YELLOW | : EARTH |
| BLUE | : NEUTRAL |
| BROWN | : LIVE |

As the colours of the wires in the mains lead of this apparatus may not correspond with the coloured markings identifying the terminals in your plug proceed as follows:

The wire which is coloured GREEN-and-YELLOW must be connected to the terminal in the plug which is marked by the letter E or by the safety earth symbol or colored GREEN or GREEN-and-YELLOW.

The wire which is coloured BLUE must be connected to the terminal which is marked with the letter N or coloured BLACK.

The wire which is coloured BROWN must be connected to the terminal which is marked with the letter L or coloured RED.

- This applies only to products distributed by Yamaha-Kemble Music (U.K.) Ltd.

IMPORTANT SAFETY INSTRUCTIONS

- 1 Read these instructions.
- 2 Keep these instructions.
- 3 Heed all warnings.
- 4 Follow all instructions.
- 5 Do not use this apparatus near water.
- 6 Clean only with dry cloth.
- 7 Do not block any ventilation openings. Install in accordance with the manufacturer's instructions.
- 8 Do not install near any heat sources such as radiators, heat registers, stoves, or other apparatus (including amplifiers) that produce heat.
- 9 Do not defeat the safety purpose of the polarized or grounding-type plug. A polarized plug has two blades with one wider than the other. A grounding type plug has two blades and a third grounding prong. The wide blade or the third prong are provided for your safety. If the provided plug does not fit into your outlet, consult an electrician for replacement of the obsolete outlet.
- 10 Protect the power cord from being walked on or pinched particularly at plugs, convenience receptacles, and the point where they exit from the apparatus.
- 11 Only use attachments/accessories specified by the manufacturer.
- 12 Use only with the cart, stand, tripod, bracket, or table specified by the manufacturer, or sold with the apparatus. When a cart is used, use caution when moving the cart/apparatus combination to avoid injury from tip-over.
- 13 Unplug this apparatus during lightning storms or when unused for long periods of time.
- 14 Refer all servicing to qualified service personnel. Servicing is required when the apparatus has been damaged in any way, such as power-supply cord or plug is damaged, liquid has been spilled or objects have fallen into the apparatus, the apparatus has been exposed to rain or moisture, does not operate normally, or has been dropped.



WARNING

TO REDUCE THE RISK OF FIRE OR ELECTRIC SHOCK, DO NOT EXPOSE THIS APPARATUS TO RAIN OR MOISTURE.

SPECIAL MESSAGE SECTION

PRODUCT SAFETY MARKINGS: Yamaha electronic products may have either labels similar to the graphics shown below or molded/stamped facsimiles of these graphics on the enclosure. The explanation of these graphics appears on this page. Please observe all cautions indicated on this page and those indicated in the safety instruction section.

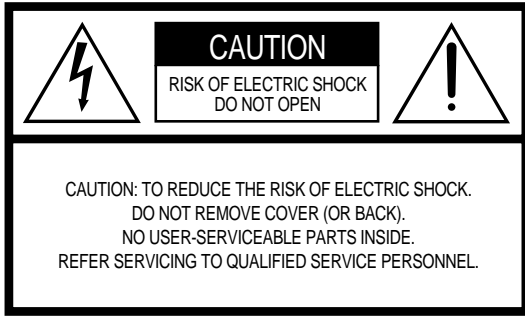

See rear of Amplifier for graphic symbol markings.



The exclamation point within the equilateral triangle is intended to alert the user to the presence of important operating and maintenance (servicing) instructions in the literature accompanying the product.

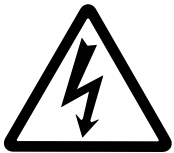

The lightning flash with arrowhead symbol, within the equilateral triangle, is intended to alert the user to the presence of uninsulated "dangerous voltage" within the product's enclosure that may be of sufficient magnitude to constitute a risk of electrical shock.

IMPORTANT NOTICE: All Yamaha electronic products are tested and approved by an independent safety testing laboratory in order that you may be sure that when it is properly installed and used in its normal and customary manner, all foreseeable risks have been eliminated. **DO NOT** modify this unit or commission others to do so unless specifically authorized by Yamaha. Product performance and/or safety standards may be diminished. Claims filed under the expressed warranty may be denied if the unit is/has been modified. Implied warranties may also be affected.

SPECIFICATIONS SUBJECT TO CHANGE: The information contained in this manual is believed to be correct at the time of printing. However, Yamaha reserves the right to change or modify any of the specifications without notice or obligation to update existing units.

ENVIRONMENTAL ISSUES: Yamaha strives to produce products that are both user safe and environmentally friendly. We sincerely believe that our products and the production methods used to produce them, meet these goals. In keeping with both the letter and the spirit of the law, we want you to be aware of the following:

Warning: Do not attempt to recharge, disassemble, or incinerate this type of battery. Keep all batteries away from children. Dispose of used batteries promptly and as regulated by applicable laws. Note: In some areas, the servicer is required by law to return the defective parts. However, you do have the option of having the servicer dispose of these parts for you.

Disposal Notice: Should this product become damaged beyond repair, or for some reason its useful life is considered to be at an end, please observe all local, state, and federal regulations that relate to the disposal of products that contain lead, batteries, plastics, etc.

NOTICE: Service charges incurred due to lack of knowledge relating to how a function or effect works (when the unit is operating as designed) are not covered by the manufacturer's warranty, and are therefore the owners responsibility. Please study this manual carefully and consult your dealer before requesting service.

NAME PLATE LOCATION: The graphic below indicates the location of the name plate and serial number label. Information such as model number, power requirements, serial number, etc., can be found at these two locations. You should record the model number, serial number, and the date of purchase in the spaces provided below and retain this manual as a permanent record of your purchase.

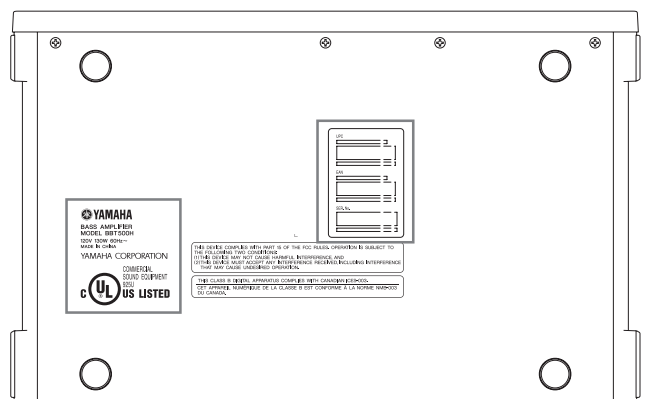

Model _____

Serial No. _____

Purchase Date _____

Precautions

- Avoid using your amplifier and speaker in the following locations to prevent possible damage:
 - In direct sunlight or next to heating equipment.
 - Extremely cold or hot locations.
 - Locations exposed to high humidity or excessive dust.
 - Locations subject to strong shocks or vibration.
- Avoid installing this unit where foreign object may fall onto this unit and/or this unit may be exposed to liquid dripping or splashing. On the top of this unit, do not place:
 - Other components, as they may cause damage and/or discoloration on the surface of this unit.
 - Burning objects (i.e. candles), as they may cause fire, damage to this unit, and/or personal injury.
 - Containers with liquid in them, as they may fall and liquid may cause electrical shock to the user and/or damage to this unit.
- Before making any connections, make sure that the power on the amplifier and any external devices is switched OFF.
- To protect the speaker from possible damage, always set the OUTPUT knob to "0" before switching the power ON/OFF.
- When connecting the speaker jack to a speaker, use only a cable designed specifically for connecting a speaker to the amplifier. The use of any other cable can result in fire.
- Even if the device's main power switch is switched OFF, power is not cut off from the device. Place the device close to an easily accessible electric outlet so it can be plugged in or unplugged with ease.
- Your Yamaha amplifier is a precision musical instrument. Handle it with care and avoid dropping or bumping it.
- Do not apply excessive force to the switches and controls.
- To prevent damage and possibly electrical shock, never open the case and tamper with the internal circuitry.
- Do not block the ventilation ducts. The device is designed with ducts on the front and back to prevent temperatures from rising inside the device. Blocking the ducts will cause heat to buildup inside the device, which may result in fire. NEVER operate the device in any of the manners described below.
 - * *Never place the device on its back, side, or upside-down.*
 - * *Install the device in anything other than the specified rack, such in a narrow bookshelf, in an small enclosed space, or a place with poor ventilation, etc.*
 - * *Cover the device with a cloth or place the device on a carpet or bed.*
- When the devices is installed in an audio rack, etc., make sure that there is sufficient space between the wall or other equipment, and the device. The device requires clearance of at least 5cm on its sides, 10cm at the back, and 10cm above. Also, open the rear of the rack, or open a hole in the back of the rack to provide the device with ventilation. Poor ventilation will cause heat to buildup inside of the device, which can result in fire.
- Never place the device on an unstable surface, table, or sloped surface. Also, never stack the device excessively. Doing so may cause the device to fall or overturn, causing injury.
 - * *If the device is to be stacked, we recommend that the casters be removed from the amplifier/speaker to prevent overturning.*
- During thunderstorms, switch off the power as soon as possible and unplug the device from the electric outlet. If there are lightning strikes, do not touch the power cable if it is still connected to the electric outlet. Doing so can result in electric shock.
- For safety, always remove the power plug from the AC wall outlet if there is any danger of lightning striking in your area.
- Do not use the amplifier for any other purpose than powering a speaker system.
- Keep the amplifier away from neon signs or fluorescent lighting to prevent noise pickup.
- Never use benzene, thinner or other volatile liquids for cleaning, as these chemicals may cause damage or discoloration to the finish. Always use a dry, soft cloth to wipe off dust and dirt.

Operating Cautions!

To use in a safe manner, please obey the following

● About the XLR jack's polarity

The pin order of the XLR type connector is as follows:

1: Shield (GND), 2: Hot (+), 3: Cold (-)

This conforms to the IEC60268 standard.

● About Cellular Phone Interference

Cellular phones used in close proximity to the device may cause noise. If this is the case, move the phone a little away from the device.

Thank you for purchasing the Yamaha BBT500H Bass Amplifier.

The BBT500H is an all-digital bass amplifier that utilizes Yamaha's DSP technology to provide bassists with extensive sound tailoring capabilities and simple operation. Thanks to the use of a highly efficient digital power amplifier in combination with Yamaha's power switching technology the BBT500H can deliver an unprecedented 500W/2Ω of power from its compact and lightweight design.

The BBT500H offers bassists precision sound tailoring and control with its 11 sound variation types, 5-band semi-parametric equalizer, compressor, limiter, and noise gate. It is also equipped with a speaker simulator and effects loop for greater tone tailoring and versatility. The BBT500H provides 5 internal memory locations that let you store up to five tone settings for instant recall at the press of a switch. It also offers MIDI compatibility and a bi-amp system (using two amplifiers to create a single system), etc. that make it an excellent choice for use in the studio or live performances.

In order to get the most out of your BBT500H and its sophisticated functions, please thoroughly read this Owner's Manual before using the device. Also, keep the manual in a safe, convenient place for future reference.

CONTENTS

| | |
|---|-----------|
| Panel Controls and Connections | 7 |
| Front Panel | 7 |
| Rear Panel | 8 |
| Operating Instructions | 10 |
| Getting sound output | 10 |
| Adjusting the Input Level | 10 |
| Sound Setting | 10 |
| Storing and Recalling Patches | 11 |
| Detailed Parameter Settings | 12 |
| Amp Mode | 12 |
| Equalizer Mode | 13 |
| Compressor Mode | 13 |
| Utility Mode | 14 |
| Attaching the Rack Mount Adaptor | 17 |
| Air Flow | 17 |
| Attaching the Clamp Filter | 17 |
| Error Messages | 18 |
| Troubleshooting | 18 |
| Specifications | 19 |
| MIDI Implementation Chart | 95 |

Panel Controls and Connections

Front Panel

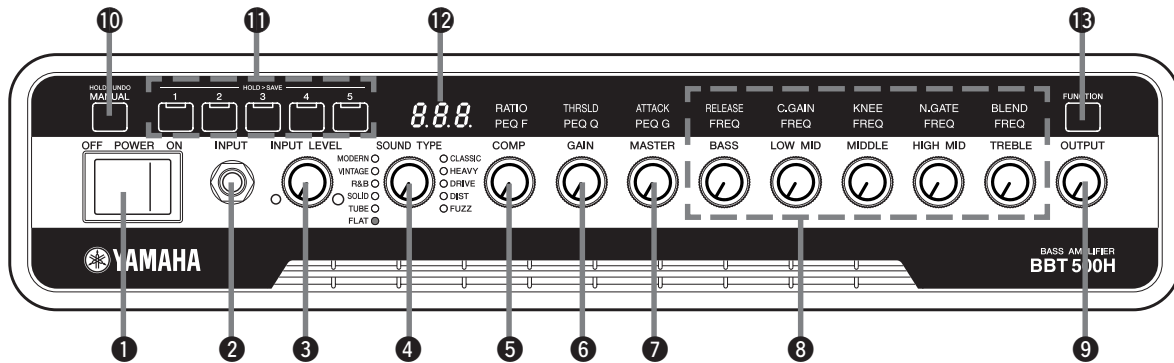

1 Power Switch

This is the unit's main power switch.

* Always set the **OUTPUT** volume to "0" before switching the power **ON** or **OFF** to protect the speaker from damage.

2 Input Jack (INPUT)

This is the unit's input jack.

Connect the output jack on your bass to this jack.

* Make sure that the power is switched **OFF** before connecting the bass.

* For U.S. and Canadian models only

To protect against electromagnetic waves, attach the supplied Clamp Filter to the cable connecting the bass guitar to the amplifier. (→ pg. 17)

3 Input Level Volume (INPUT LEVEL)

Adjusts the amplifier's input volume level and the volume of the bass that is connected to the BBT500H. Use the indicators located on either side of the knob to check the signal level. (→ pg. 10)

* The **INPUT LEVEL** setting is not saved in memory.

4 Sound Type Select Switch (SOUND TYPE)

Select one of the eleven preset sound variation types.

The indicator of the selected sound type will light. (→ pg. 10)

5 Compressor Volume (COMP)

Adjusts the compressor's compression ratio.

In the Equalizer mode, this knob is used to set the center frequency (PEQ F) of the 1-band parametric equalizer. (→ pg. 13)

6 Gain Volume (GAIN)

Adjusts the pre-amplifier's gain volume level.

* When this knob is set to "0", no sound will be produced although the **Master Volume** is turned up.

In the Equalizer Mode, this knob is used to set the bandwidth (PEQ Q) of the 1-band parametric equalizer. (→ pg. 13)

In the Compressor Mode, this knob is used to set the compressor threshold (THRSLD). (→ pg. 13)

7 Master Volume (MASTER)

Adjusts the overall volume of the sound created with the Gain and Tone Control settings. Adjusts the preamplifier's output level.

* The **MASTER** volume setting is saved in memory.

In the Equalizer Mode, this knob is used to set the Gain (PEQ G) volume level of the 1-band graphic equalizer. (→ pg. 13)

In the Compressor Mode, this knob is used to adjust the compressor's attack (ATTACK) time. (→ pg. 13)

8 Tone Controls

(BASS, LOW MID, MIDDLE, HIGH MID, TREBLE)

Adjusts the level of their corresponding frequencies.

In the Equalizer Mode, these knobs are used to set the center frequency (FREQ) for their corresponding tone control. (→ pg. 13)

In the Compressor Mode, these knobs are used to adjust the parameters given below. (→ pg. 13)

BASS Compressor's release (RELEASE) time
LOW MID Compressor's output gain (C. GAIN)
MIDDLE Compressor's knee (KNEE)
HIGH MID Noise gate threshold (N. GATE)
TREBLE Effect loop blend level (BLEND)

9 Output Volume Level (OUTPUT)

Adjusts the power amplifier's output level.

This knob is used to set the overall volume level (the amount delivered by the speaker) of the sound created by the pre-amplifier section's GAIN, MASTER, Tone Controls, etc. Adjusting this volume level has no effect on tone.

* The **OUTPUT** level setting is not saved in memory.

* This setting does not effect the output level (volume) of the **LINE OUT** jack.

10 Manual Switch (MANUAL)

This switch resets all parameter values (including Equalizer and Compressor mode settings) to the state they were in when the power was switched ON. All knobs function as labeled on the panel, and the setting for each control corresponds to the position of the knob.

If you continuously hold the switch, all settings will be returned to the state that they were in just before the [MANUAL] or Memory switch was pressed (Undo Function). (→ pg. 12)

11 Memory Switches (1-5)

These switches are used to recall data for patches (1-5) saved in the unit's memory. The selected memory's (switch's) indicator lights. (→ pg. 11)

After editing patch data, press and hold the switch for about 1 second to save the data to memory. (→ pg. 11)

12 Display

Displays information such as parameter values, etc.

13 Function Switch (FUNCTION)

This switch is used to select the unit's operating mode.

- **Amp Mode** (→ pg. 12)
- **Equalizer Mode** (→ pg. 13)
- **Compressor Mode** (→ pg. 13)
- **Utility Mode** (→ pg. 14)

Rear Panel

Before making any connections, make sure that the power on the BBT500H and all other related devices is switched OFF.

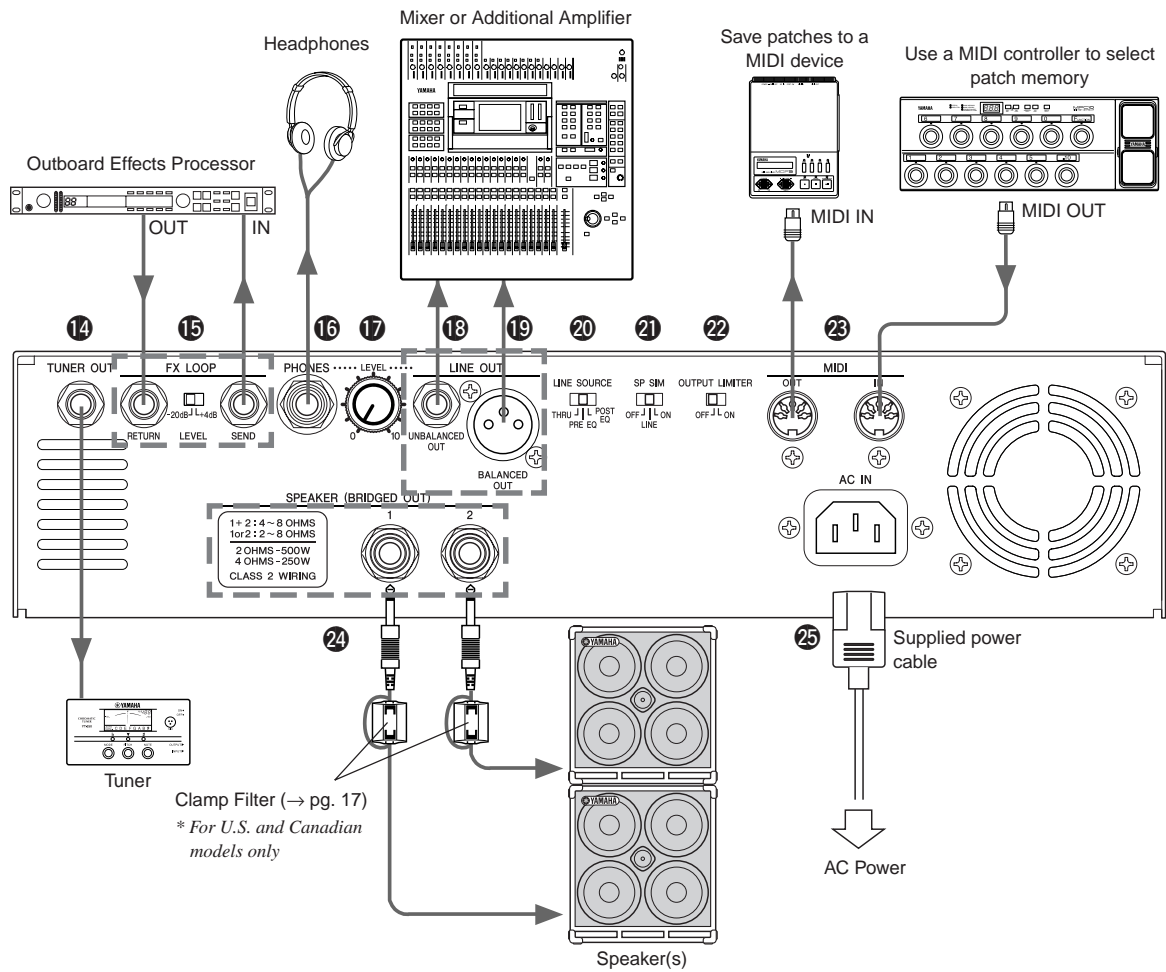

14 Tuner Output (TUNER OUT)

This output jack is used to connect a tuner to the BBT500H. It can also be used to create a bi-amp system. Connect this output jack to the INPUT jack on another BBT500H. (→ pg. 14)

15 Effect Loop (FX LOOP)

- Effect Send Jack (SEND)
- Effect Return Jack (RETURN)
- Effect Loop Level Switch (LEVEL)

These jacks let you insert an outboard effects processor between the SEND and RETURN jacks to apply effects to the BBT500H's signal. Use the Level Switch to match the Input/Output level with the level required by the outboard effects processor. Use the BLEND control in the Compressor Mode to adjust the balance level between the outboard effector's sound and the sound that is created by the BBT500H. (→ pg. 13)

16 Headphones Jack (PHONES)

This jack is used to connect a pair of headphones to the unit. It carries the same signal that is delivered from the LINE OUT jack. Use the LEVEL control to adjust the volume.

17 Headphones/Line Out Level Control (LEVEL)

Adjusts the output level of the PHONES jack and the LINE OUT jacks. (The same setting is applied to both jacks.)

18 Line Out Jack (UNBALANCED OUT, BALANCED OUT)

These jacks carry the signal that is selected with the 19 Line Out Source Switch at a line level.

Both unbalanced phone type (+4 dB/10 kΩ) and balanced XLR type (+4 dB/600 Ω) jacks are provided.

Use the LINE SOURCE switch to select the signal that is sent to the LINE OUT jack. As the unit is equipped with an output limiter and speaker simulator (can be switched ON/OFF), and the output level of these jacks is controlled by the LEVEL control, these jacks can be used to send a line level signal to a mixing console or an additional amplifier.

19 Line Out Source Switch (LINE SOURCE: THRU/PRE EQ/POST EQ)

This switch is used to select the signal that is delivered from the LINE OUT jack.

- THRU** Delivers the signal received via the INPUT jack without alteration.
Select this setting when connecting to a DI (Direct Injection) box.
- PRE EQ** Delivers the signal before it has been processed by the tone controls (the Sound Type is active).
This setting can be used when separate EQ settings are required for speaker and line outputs.
- POST EQ** Delivers the signal after it has been processed by the tone controls.

This setting can be used when you want the line signal processed with the same EQ setting as the speaker.

* The FX LOOP is active on both PRE EQ and POST EQ signals.

20 Speaker Simulator Switch (SP SIM: OFF/LINE/ON)

This switch is used to switch the Speaker Simulator circuit ON/OFF. When the Speaker Simulator is activated, this special circuit adds the live characteristics of a speaker to the line out signal and headphones output. This feature is useful when you want to produce a distorted tone with a speaker system that incorporates a tweeter, or to add the resonance of a large speaker and its enclosure to a speaker system that uses only small speakers. The sound created with the Speaker Simulator is optimized to compliment the selected Sound Type.

OFF Deactivates the Speaker Simulator on LINE OUT, SPEAKER, and PHONES jack signals.

LINE Activates the Speaker Simulator on LINE OUT, and PHONES jack signals only.

ON Activates the Speaker Simulator on LINE OUT, SPEAKER, and PHONES jack signals.

* The Speaker Simulator can only be applied to the LINE OUT jack output when the 19 Line Out Source Switch is set to "POST EQ".

21 Output Limiter Switch (OUTPUT LIMITER: ON/OFF)

This switch is used to switch the Output Limiter circuit ON/OFF. When set to the ON position, the limiter suppresses the signal if it exceeds the threshold before sending it to the SPEAKER jack and LINE OUT jack.

OFF Deactivates the Limiter on both LINE OUT and SPEAKER jack signals.

ON Activates the Limiter on both LINE OUT and SPEAKER jack signals.

22 MIDI OUT Jack

Connect this jack to the MIDI IN jack on an external MIDI device that can save MIDI data (such as a MIDI data filer, etc.), and save patch data from the BBT500H to an external device. (→ pg. 16: MIDI Bulk Out) Also, when MIDI Merge is set ON, MIDI data received from an external MIDI device via the MIDI IN jack is transmitted from the MIDI OUT jack without alteration. (→ pg. 16)

23 MIDI IN Jack

Connect this jack to the MIDI OUT jack on MIDI Foot Controller, etc., to select patches, control volume, etc., with the MIDI Foot Controller. (→ pg. 15) Also, patches that have been saved to an external MIDI device can be loaded into the BBT500H's internal memory. (→ pg. 16: MIDI Bulk IN)

24 Speaker Jacks (SPEAKER 1, 2)

Two Speaker Jacks are provided for connecting speaker systems. The two jacks are connected in parallel inside the unit. Make sure that the speaker cabinet you use meets the requirements given below.

● When using a single SPEAKER Jack (1 or 2)

Please use a system that complies with one of the following requirements.

- The total impedance* of the circuit should never be less than 2Ω.
- A 2Ω speaker system must have a power handling capability of 500W or greater.
- A 4Ω speaker system must have a power handling capability of 250W or greater.
- An 8Ω speaker system must have a power handling capability of 125W or greater.

● When using both SPEAKER Jacks (1 & 2)

Please use a system that complies with one of the following requirements.

- The total impedance* of the circuit should never be less than 2Ω.
- A 4Ω speaker system must have a power handling capability of 250W or greater.
- An 8Ω speaker system must have a power handling capability of 125W or greater.

To obtain optimum performance from the amplifier, we recommend that a speaker system with a power handling capability of 250W or greater and impedance of 4Ω be used with each SPEAKER jack (1 and 2).

* For U.S. and Canadian models only

To protect against electromagnetic waves, attach the supplied Clamp Filters to the cables connecting the amplifier's SPEAKER 1, 2 jacks to the speakers. (→ pg. 17)

25 Power Connector (AC IN)

Connect the supplied power cable to this terminal to supply the unit with power from an AC power outlet.

When connecting the power cable, make sure the amplifier's POWER switch is turned OFF.

*** Total Impedance**

Whenever two or more speaker cabinets are connected to the unit, consideration must be given to the total impedance of the speaker system.

Normally, a speaker cabinet has an impedance of 4, 8 or 16Ω. But when two or more speaker cabinets are used together, the total impedance will change according to the manner in which the cabinets are connected.

● Connecting in a Series

Total impedance = 1st Speaker + 2nd Speaker + 3rd Speaker ...

Connecting three 4Ω speaker cabinets in a series as shown below, results in a total impedance of 12Ω.

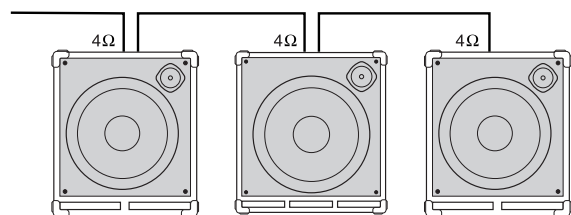

● Connected in Parallel

$$\text{Total impedance} = \frac{1}{\frac{1}{1^{\text{st}} \text{ Speaker}} + \frac{1}{2^{\text{nd}} \text{ Speaker}} + \frac{1}{3^{\text{rd}} \text{ Speaker}} + \dots}$$

Connecting three 4Ω speaker cabinets in a parallel configuration as shown below, results in a total impedance of about 1.3Ω.

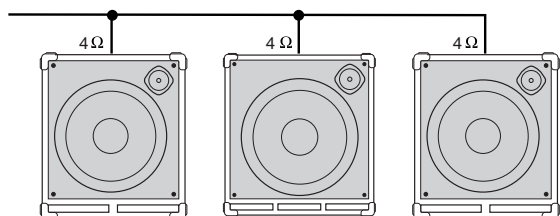

Operating Instructions

Getting sound output

- 1 First, make sure that the **POWER** switch is switched **OFF**, then connect your bass to the **INPUT** Jack on the front panel.
- 2 Rotate the **OUTPUT** knob fully to the left and then switch the **POWER** switch **ON**.

To protect the speakers, make sure that the OUTPUT knob is set to "0" whenever switching the POWER switch ON or OFF.

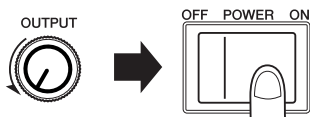

- 3 First, set the **INPUT LEVEL** knob to its 12 O'clock position, then while playing the bass, gradually increase the **GAIN**, **MASTER**, and **OUTPUT** knobs to adjust the sound.
- 4 Once the system is producing sound, set the input level as described in the "Adjusting the Input Level" section below.

Adjusting the Input Level

The **INPUT LEVEL** control optimizes the signal received from the bass for use with the amplifier, to produce wide dynamic range and rich tone. A poorly adjusted level results in noise, feedback, a cutup sound, etc.

* Since output levels vary from instrument to instrument, you will need to readjust the input level to match the instrument's output level whenever you change instruments.

- 1 Rotate the volume control on your bass to its maximum level and play loudly while rotating the **INPUT LEVEL** knob. An ideal level is attained when the green indicator is lit.
- 2 Continue to rotate the **INPUT LEVEL** knob to the right making sure the red indicator does not light. As long as the red indicator does not light, rotate the knob fully to the right.

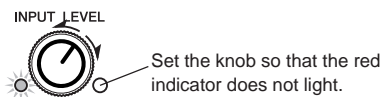

Sound Setting

When the power is switched **ON**, all control knobs function as labeled on the panel and described below. All lamps on the display above the control knobs and switches are unlit.

Rotate the **SOUND TYPE** knob to select a sound type, then use the **Tone Control** knobs to shape the sound. Before selecting a sound type, first set the **GAIN** through **TREBLE** control knobs to their center positions then try out the different **Sound Types**.

Also, the **COMP** knob is used to adjust the compressor's compression ratio. The compressor automatically balances the differences between loud and soft levels when playing. Rotate the knob to the right to increase the amount of compression.

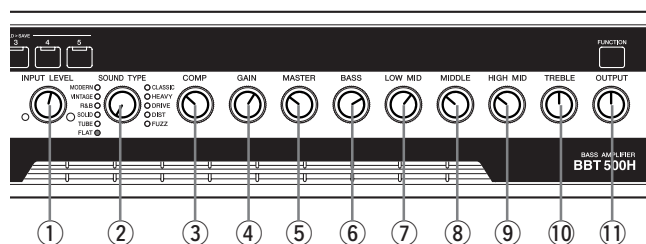

- ① **INPUT LEVEL**: Sets the Input Level
- ② **SOUND TYPE**: Selects the Sound Type (11 types)
 - FLAT A clean tone with all frequencies set flat. This setting also works well with an upright bass or an electric-acoustic bass.
 - TUBE A clear and warm tube type sound. This setting also works well with an upright bass or an electric-acoustic bass.
 - SOLID A fat solid-state type sound
 - R & B A fat R & B type sound
 - VINTAGE A vintage tone with warm mid frequencies
 - MODERN A modern sound with rich low-end and bright high-end
 - CLASSIC Rock bass sound
 - HEAVY A heavier sound than the CLASSIC setting
 - DRIVE Overdrive bass sound
 - DIST Distortion bass sound
 - FUZZ Fuzz bass sound
- ③ **COMP**: Compression Ratio (1.0 to ∞, 16 steps)
This adjusts the compressor's compression ratio and output levels simultaneously. As the value increases, so does the amount of compression applied to signals that exceed the threshold level (→ pg. 13).
- ④ **GAIN**: Pre-Amp Gain (0 to 10, 0.1 step)
- ⑤ **MASTER**: Master Volume (0 to 10, 0.1 step)
- ⑥ **BASS**: Bass Frequency (-15dB to +15dB, 0.2dB step)
- ⑦ **LOW MID**: Low Mid Frequency (-15dB to +15dB, 0.2dB step)
- ⑧ **MIDDLE**: Middle Frequency (-15dB to +15dB, 0.2dB step)
- ⑨ **HIGH MID**: High mid Frequency (-15dB to +15dB, 0.2dB step)
- ⑩ **TREBLE**: Treble Frequency (-15dB to +15dB, 0.2dB step)
- ⑪ **OUTPUT**: Sets the output level

HINT Using the OUTPUT and MASTER Controls

Both knobs can be used to control the overall volume however, the **MASTER** knob is the preamplifier's master volume and its setting is saved in memory. The **OUTPUT** knob is the power amplifier's output volume and its setting is not saved in memory. Use the **MASTER** knob to set individual volume settings of patches saved to memory, and use the **OUTPUT** knob to set the output volume level produced by the speakers.

Storing and Recalling Patches

After creating a sound that you like, you can store its settings in the unit's internal memory. Sound setting data (individual knob settings) is called a **Patch**. Saving a patch to the unit's internal memory is called **Store**.

The BBT500H provides five memory locations for storing patch data. Patch data in the memory is stored even when the power is switched OFF, and can be recalled at any time by pressing the patch's corresponding switch. Take note that unless the changes are saved to memory, any changes made to the patch will be lost when another patch is selected or when the power is switched OFF.

Storing a Patch

After creating a sound you want to keep for later use, press and hold any one of the Memory Switches (1-5) until all of the front panel indicators light.

Ex.) Press and hold Memory Switch [1] until all indicators light.

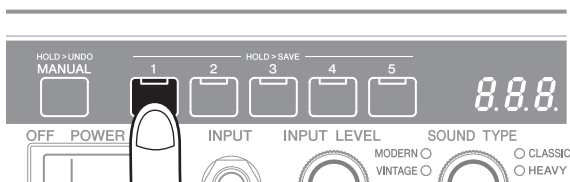

* INPUT LEVEL and OUTPUT LEVEL settings are not stored in memory.

Recalling a Patch

To use one of the patches stored in memory, just press the Memory Switch [1]-[5] to which the data is stored.

The indicator of the selected Memory Switch lights.

Ex.) Recalling the patch stored to Memory Switch [2].

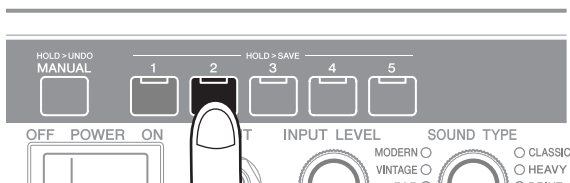

After you recall or store a patch, the value for each knob will appear in the display when the knob (COMP - TREBLE) is used.

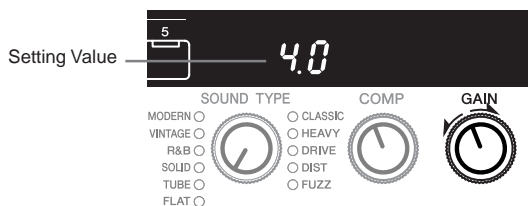

However, if the value set in the patch is different than the knob's actual position, the patch's value will flash in the display but it will not change, nor will the sound, even though you are turning the knob. For more information on this situation, refer to the "Knob Position and Settings" section below.

● Knob Position and Settings

When a patch is recalled from memory, etc., it may be that the knob's actual position differs from the value set in the recalled patch.

In this case, the BBT500H is programmed to flash the patch's value on the display without changing it or the sound until the knob's position corresponds to the value in the recalled patch setting.

If the display flashes when rotating the knob, continue rotating the knob until its position matches the flashing value. When the position and value match, the value will stop flashing on the display and change as the knob is turned.

Ex.) If the GAIN knob is pointing at the "3 o'clock" position and a patch with a GAIN setting of 4.0 is recalled.

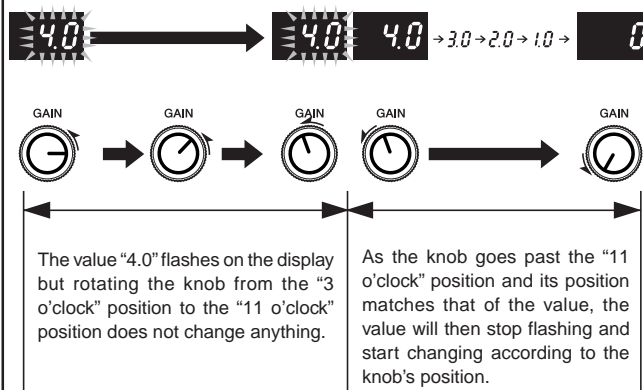

● The Useful "Undo" Function

Press and hold the [MANUAL] switch activates the "Undo" function, which returns settings to the condition they were in prior to pressing a Memory Switch [1]-[5] or the [MANUAL] switch.

This function is useful in cases such as:

You've just made some changes to the patch saved in Memory Switch [1] but pressed Memory Switch [2] before you could save the changes to memory. Press and hold the [MANUAL] switch to return the settings to the same condition they were in before you pressed Memory Switch [2].

In the same manner, you made some changes to a patch but pressed the [MANUAL] switch before you could save those changes to memory. Press and hold the [MANUAL] button to restore your changes.

Detailed Parameter Settings

The BBT500H also features more precise settings for defining the frequencies for each of the Tone Control knobs, operating the Compressor and Noise Gate, or setting the Blend Level of the effect loop, etc. To access these settings, press the [FUNCTION] switch and use the four Modes described below.

- **Amp Mode**

In this mode, each knob functions in the manner it is labeled on the front panel.

- **Equalizer Mode**

This mode is used to set the 1-band parametric equalizer and the center frequency for each of the Tone Controls (Bass – Treble).

- **Compressor Mode**

This mode is used to set the Compressor's blend level, noise gate level, and effect loop.

- **Utility Mode**

This mode is used to set the crossover filter, and individual MIDI settings.

Individual settings in the Amp Mode, Equalizer Mode, and Compressor Mode are saved when patch data is saved to the unit's memory. Individual parameter settings in the Equalizer Mode and Compressor Mode are set to their default values when the power is switched ON. Individual settings in the Utility Mode are saved when exiting the Utility Mode, and they are retained even if the power is switched OFF.

Amp Mode

Each knob functions in the manner it is labeled on the panel.

In the Amp Mode, the knob's value (or patch's setting value) is shown on the display when the knob is turned.

** After the BBT500H's power is switched ON or the [MANUAL] switch is pressed, nothing is shown in the display until a Memory is recalled, or a mode other than the Amp Mode is selected.*

Enter the Amp Mode using one of the following methods.

- **The Amp Mode is the default mode when the BBT500's power is switched ON.**
- **Press the [MANUAL] Switch to enter the Amp Mode.**
- **Press a Memory Switch [1] – [5] to recall a patch. Or, press and hold a Memory Switch to save a patch to memory.**
- **In the Equalizer, Compressor, or Utility Mode, press the [FUNCTION] switch.**

• How Knobs Function in the Amp Mode

The knob's value is shown on the display when the knob is turned.

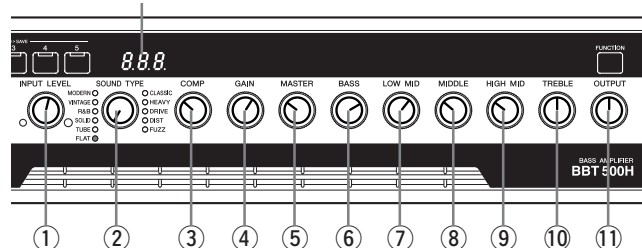

Each control knob's function in the Amp Mode is the same as described in the "Sound Setting" section (→ pg. 10).

- ① **INPUT LEVEL:** Sets the Input Level
- ② **SOUND TYPE:** Selects the Sound Type (11 types)
- ③ **COMP:** Compression Ratio (1.0 to ∞, 16 steps)
- ④ **GAIN:** Pre-Amp Gain (0 to 10, 0.1 step)
- ⑤ **MASTER:** Master Volume (0 to 10, 0.1 step)
- ⑥ **BASS:** Bass Frequency (-15dB to +15dB, 0.2dB step)
- ⑦ **LOW MID:** Low Mid Frequency (-15dB to +15dB, 0.2dB step)
- ⑧ **MIDDLE:** Middle Frequency (-15dB to +15dB, 0.2dB step)
- ⑨ **HIGH MID:** High mid Frequency (-15dB to +15dB, 0.2dB step)
- ⑩ **TREBLE:** Treble Frequency (-15dB to +15dB, 0.2dB step)
- ⑪ **OUTPUT:** Sets the output level

Equalizer Mode

The Equalizer mode lets you make settings for the internal 1-Band Parametric Equalizer, and set the center frequency (or in the case of the TREBLE control knob, its cutoff frequency) for each of the panel's Tone Controls (BASS – TREBLE) in the internal five-band equalizer.

To enter the Equalizer mode, press the [FUNCTION] switch. Knob functions are displayed in the bottom row of the panel display above the knobs.

● How Knobs Function in the Equalizer Mode

The knob's value is shown on the display when the knob is turned.

The function of each knob is displayed here.

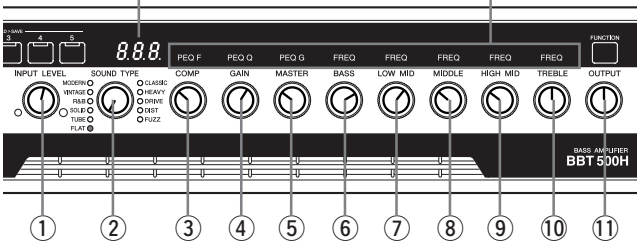

- ① **INPUT LEVEL:** Sets the Input Level
- ② **SOUND TYPE:** No function.
- ③ **COMP (PEQ F):** Sets the center frequency of the 1-band parametric equalizer (20Hz to 20.0kHz, 255 steps)
- ④ **GAIN (PEQ Q):** Sets the bandwidth of the 1-band parametric equalizer. (0.1 to 20.0, 255 steps)
- ⑤ **MASTER (PEQ G):** Sets the gain level of the 1-band parametric equalizer. (-15dB to +15dB, 0.2dB step)
- ⑥ **BASS (FREQ):** Sets the center frequency of the BASS control knob. (20Hz to 320Hz, 255 steps)
- ⑦ **LOW MID (FREQ):** Sets the center frequency of the LOW MID control knob. (80Hz to 1.28kHz, 255 steps)
- ⑧ **MIDDLE (FREQ):** Sets the center frequency of the MIDDLE control knob. (250Hz to 4.00kHz, 255 steps)
- ⑨ **HIGH MID (FREQ):** Sets center frequency of the HIGH MID control knob. (500Hz to 8.00kHz, 255 steps)
- ⑩ **TREBLE (FREQ):** Sets the center/cutoff frequency of the TREBLE control knob. (1.25kHz to 20.0kHz, 255 steps)
- ⑪ **OUTPUT:** Sets the output level

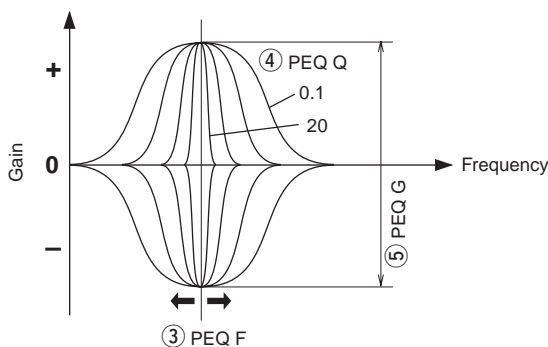

Compressor Mode

The Compressor Mode provides settings for the Compressor, Noise Gate, and Blend Level for the effect loop.

To enter the Compressor Mode, press and hold the [FUNCTION] switch until the knob functions are displayed in the upper row of the panel display above the knobs (the row above that used by the Equalizer Mode).

● How Knobs Function in the Compressor Mode

The knob's value is shown on the display when the knob is turned.

The function of each knob is displayed here.

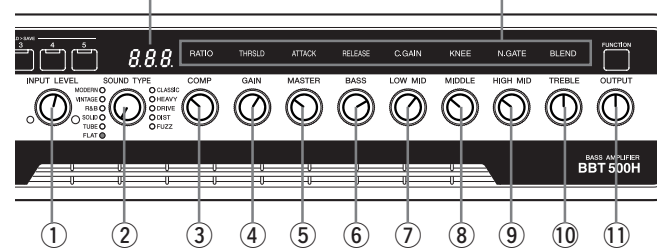

- ① **INPUT LEVEL:** Sets the Input Level
- ② **SOUND TYPE:** No function.
- ③ **COMP (RATIO):** Compression ratio (1.0 - ∞, 16 steps) *operates the same as COMP in the Amp Mode.
- ④ **GAIN (THRSLD):** Compressor threshold level (-54dB to 0dB, 1dB step)
Sets the signal level from which the compressor will activate. Compression is applied to signals that exceed this level.
- ⑤ **MASTER (ATTACK):** Compressor attack time (0msec to 120msec, 1msec step).
Sets the amount of time required for application of the compressor from the time the signal exceeds the threshold. When a slow attack time is set, the beginning of the attack will not be compressed.
- ⑥ **BASS (RELEASE):** Compressor release time (5msec to 42.3 sec, 160 steps).
Sets the amount of time required for the compressor to switch off after the signal goes below the threshold level. This smoothes gain changes to keep the sound natural.
- ⑦ **LOW MID (C. GAIN):** Compressor gain (0dB to 18dB, 0.1dB step)
This parameter works in conjunction with the compressor ratio setting which is set with the ③ COMP (RATIO) control knob. In other words, gain is automatically adjusted along with amount of compression applied to the signal. If the Ratio = "1.0", Gain = "0". If the Ratio = "∞", Gain = the setting determined with the control knob.
- ⑧ **MIDDLE (KNEE):** Compressor knee (Hd (Hard), 1, 2, 3, 4, 5)
Sets the depth of signal compression after the input signal exceeds the threshold level. When set to Hd (hard), compression starts soon with the ratio you have set. However, when set to 1-5, compression startup is gradual, creating a more natural sound (soft knee compression).
- ⑨ **HIGH MID (N. GATE):** Noise gate threshold level (OFF, -53dB to 0dB, 1dB step)
When the input signal's level falls below this set level, the noise gate activates cutting off the signal.
- ⑩ **TREBLE (BLEND):** Blend level between the effect loop's RETURN signal and the dry signal (the sound created in the BBT500H) (0% (Return 0%, Dry 100%) to 100% (Return 100%, Dry 0%)).
- ⑪ **OUTPUT:** Sets the output level

Detailed Parameter Settings

Utility Mode

The Utility Mode provides settings for the Crossover Filter and MIDI. These settings are saved internally when you exit the Utility Mode and kept even when the amplifier's power is switched OFF.

● Entering the Utility Mode

To enter the Utility Mode, from any mode press and hold the [FUNCTION] switch for more than 3 seconds, until "u t l" appears on the display.

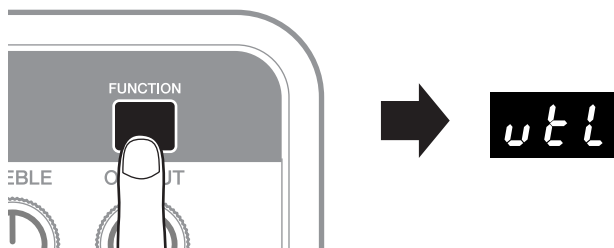

● How Knobs Function in the Utility Mode

In the Utility Mode, only the INPUT LEVEL, OUTPUT, and COMP knobs function. All other knobs (SOUND TYPE, GAIN - TREBLE) have no function.

- **INPUT LEVEL:** Sets the Input Level
- **OUTPUT:** Sets the output level
- **COMP:** Sets the cut off frequency of the crossover filter

When the COMP knob is used (when setting the crossover filter), the setting's value is shown in the display. Other than that, only "u t l" appears on the display.

Use the [MANUAL] switch and Memory Switches [1] through [5] to set individual MIDI settings. (→ [MIDI Settings] pg. 15)

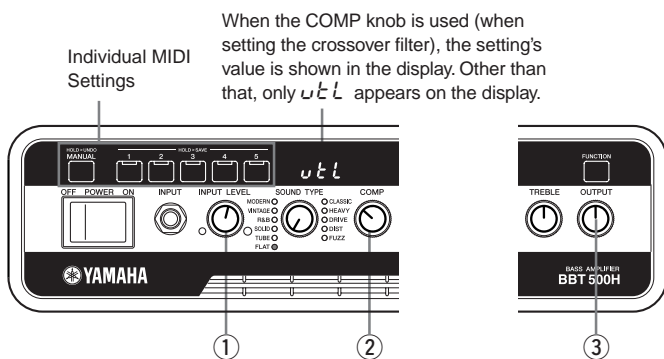

Crossover Filter

By connecting two BBT500Hs as shown in the illustration below, you can create a bi-amplified system, where one amplifier is used to drive high frequencies and a second amplifier drives low. This system uses the amplifier's onboard crossover filter (LPF or HPF) to determine the range of frequencies that each amplifier will deliver.

● Setting the Crossover Filter

- 1 Press and hold the [FUNCTION] switch for more than three seconds (until "u t l" appears on the display) to enter the Utility Mode.
- 2 Rotate the COMP knob to set the Crossover filter's cutoff frequency.

* Range of cutoff frequency
 L 10 (LPF 100Hz) to L 00 (LPF 1000Hz), b 4P (Bypass),
 h 10 (HPF 100Hz) to h 00 (HPF 1000Hz), 93 steps

When using a bi-amplified system, make sure that the INPUT LEVEL control knob on the second BBT500H is set to its minimum level.

Ex.) Operating a bi-amplified system in which the crossover filter on the first amplifier is set to h50 (HPF 500Hz) to produce high frequencies, and the crossover filter on the second amplifier is set to L50 (LPF 500Hz) to produce low frequencies.

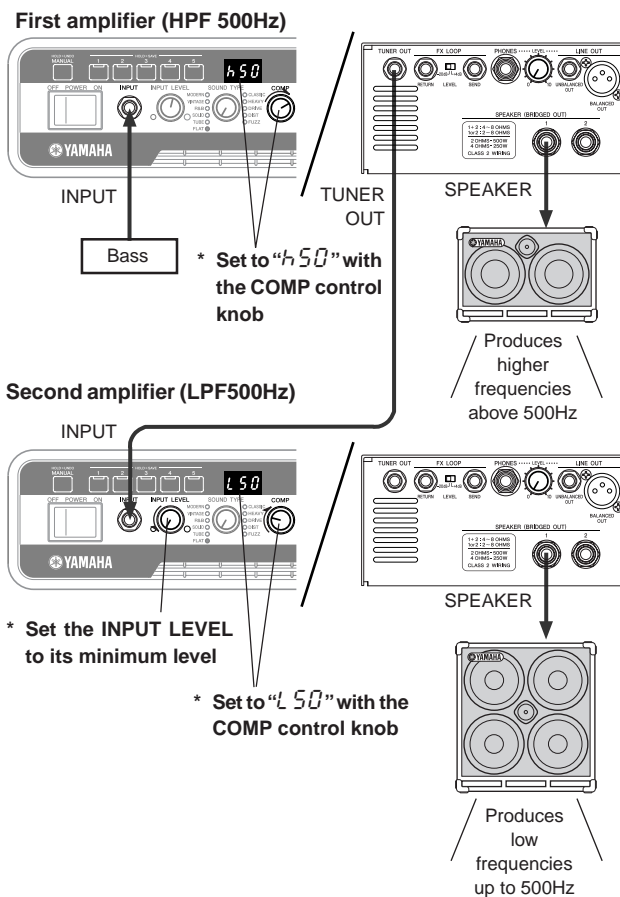

MIDI Settings

The BBT500H is MIDI* compatible and equipped with MIDI IN and MIDI OUT jacks.

* What is MIDI?

The acronym for Musical Instruments Digital Interface, MIDI is a worldwide standard communication interface that allows MIDI compatible musical instruments, computers, and other MIDI devices to share musical information and control one another regardless of instrument type or maker.

With MIDI functions you can do things like select a patch from the BBT500H's memory using an external MIDI device like the MFC10 Yamaha MIDI Foot Controller, etc. You can also backup data by sending the contents in the unit's memory to a device that is capable of saving MIDI data (Yamaha MDF3, etc.).

● Selecting a Patch with MIDI

1 Using a MIDI cable, connect the MIDI IN jack on the BBT500H to the MIDI OUT jack on the external MIDI device.

* Use only a standard MIDI cable that is less than 15 meters in length. Use of a longer cable can result in trouble such as abnormal operation, etc.

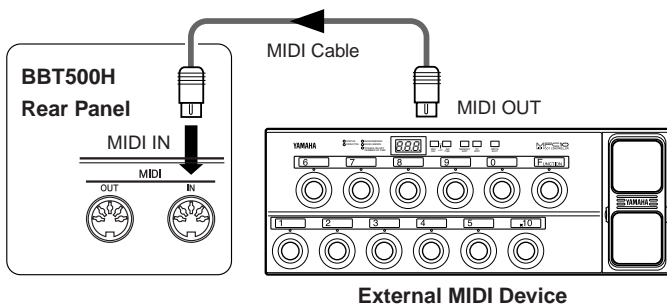

2 Set the MIDI receive channel on the BBT500H and the MIDI transmit channel on the external device to the same MIDI channel. (Default channel: 1)

* MIDI data can not be transmitted or received if the MIDI channels are not properly matched.

2-1 Press and hold the [FUNCTION] switch for more than three seconds (until “u t L” appears on the display) to enter the Utility Mode.

2-2 While holding the [MANUAL] switch, press Memory Switch [3]. The currently assigned MIDI receive channel appears on the display (after a few seconds, the display will return to “u t L”).

MIDI Receive Channel

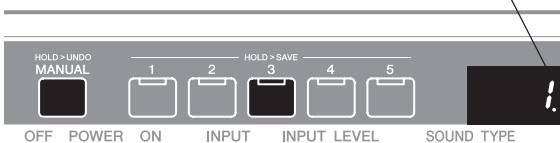

2-3 Use Memory Switches [1] and [2] to set the MIDI receive channel (1-16, ALL, OFF). Use Memory Switch [2] to increase the value, and Memory Switch [1] to decrease the value.

* “ALL” is set to Omni On. When “OFF” is set, MIDI data will not be received.

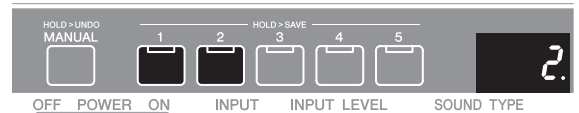

3 Create a Program Change Map*.

(Default → Program Change No: Memory No = 1:1, 2:2, 3:3, 4:4, 5:5, 6:1, 7:2, 8:3 ...)

* What is a Program Change Map?

A Program Change Map assigns a program change number (received via MIDI) to a memory number. For example, when the BBT500H receives “Program Change Number 1” from an external MIDI device, it will recall memory number “3”. This is also called a Program Change Table.

3-1 Press and hold the [FUNCTION] switch for more than 3 seconds (until “u t L” appears on the display) to enter the Utility Mode.

3-2 While holding the [MANUAL] switch, press Memory Switch [1]. The currently assigned MIDI program change number appears on the display (after a few seconds, the display will return to “u t L”).

Receive Program Change Number

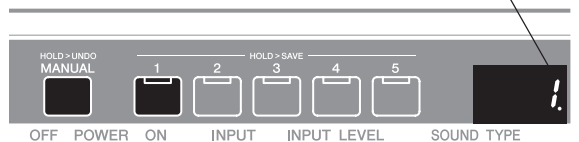

3-3 Use Memory Switches [1] and [2] to set the program change number (1-128) that is received by the BBT500H. Use Memory Switch [2] to increase the value and Memory Switch [1] to decrease the value.

3-4 While holding the [MANUAL] switch, press Memory Switch [2]. The memory number that will be recalled when the program change number that was set in step 3-3, appears on the display. (After a few seconds, the display will return to “u t L”).

Memory Number

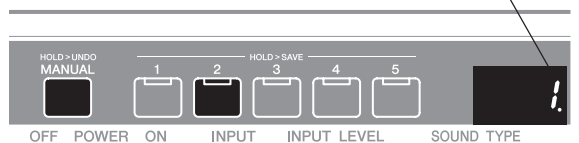

3-5 Use Memory Switches [1] and [2] to set the memory number (1-5) that corresponds to the program change number received by the BBT500H. Use Memory Switch [2] to increase the value and Memory Switch [1] to decrease the value.

3-6 If necessary, repeat steps 3-2 through 3-5.

3-7 Press the [FUNCTION] switch to enter the Amp Mode.

4 Now, when a program change number transmitted from an external MIDI device is received by the BBT500H, it will recall the corresponding memory number that is set in the program change map you just created will be recalled.

* Refer to the Owner's Manual that came with your MIDI device on how to receive or transmit program change data.

Detailed Parameter Settings

● MIDI Merge Settings

If you want MIDI signals received by the BBT500H's MIDI IN jack transmitted without alteration to other MIDI devices connected to the BBT500H's MIDI OUT jack, set the MIDI Merge to "on", if not, set it to "oFF".

- 1 Press and hold the [FUNCTION] switch for more than three seconds (until "uEL" appears on the display) to enter the Utility Mode.
- 2 While holding the [MANUAL] switch, press Memory Switch [4]. The current MIDI Merge setting appears on the display (after a few seconds the display will return to "uEL").

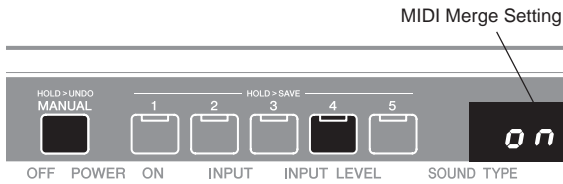

- 3 Use Memory Switches [1] and [2] to set MIDI Merge either "on" (Memory Switch [2]) or "oFF" (Memory Switch [1]).
- 4 Press the [FUNCTION] switch to enter the Amp Mode.

● MIDI Bulk Out

You can use the MIDI Bulk Out operation to back up data saved in the BBT500H (data in memory 1-5 and Utility Mode settings) to a device that can save MIDI data (such as a Yamaha MDF3, etc.).

- 1 Using a MIDI cable, connect the MIDI OUT jack on the BBT500H to the MIDI IN jack on an external MIDI device.

* Use only a standard MIDI cable that is less than 15 meters in length. Use of a longer cable can result in trouble such as abnormal operation, etc.

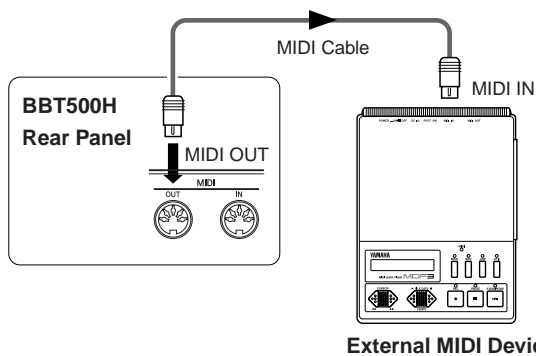

- 2 Hold the [FUNCTION] switch for more than three seconds (until "uEL" appears on the display) to enter the Utility Mode.
- 3 While holding the [MANUAL] switch, press Memory Switch [5]. The type of data to be sent with the Bulk Out operation appears on the display (after a few seconds the display will return to "uEL").

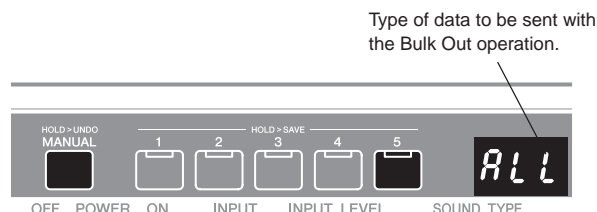

- 4 Use Memory Switches [1] and [2] to set the type of data (1-5, ALL) to be sent with the Bulk Out operation.

1-5 Sends only the data from the selected memory number.
ALL Sends all data in memory numbers 1-5 and Utility Mode settings.

- 5 Press Memory Switch [5] to carry out the Bulk Out operation. While the Bulk Out operation is in progress, all lamps on the unit will light.

* The device number becomes the MIDI receive channel number (→ pg. 15). When the MIDI receive channel is set to "ALL" (Omni ON), the channel is set to 1.

- 6 Press the [FUNCTION] switch to enter the Amp Mode.

● About MIDI Control Changes

You can control the overall volume of the BBT500H by connecting an external MIDI device's MIDI OUT jack to the BBT500H's MIDI IN jack, and transmit Number 7 Control Change Messages (Main Volume) to the BBT500H.

- * With the exception of the Number 7 Control Change, the BBT500H does not recognize any other MIDI Control Change messages.
- * The Main Volume data will not change, even if a different memory number is selected.
- * When the POWER is switched ON, the Main Volume data is set to its MAX value.
- * After the Main Volume data is changed, and the external MIDI device is disconnected, the pre-amp's volume level may not be sufficient. In this case occurs, transmit a Control Change with a higher volume setting again, or switch the POWER OFF and then back ON.

● About MIDI Bulk In

Using a MIDI cable, connect the MIDI IN jack on the BBT500H to the MIDI OUT jack on an external MIDI device to return data that has been stored on the external device, to the BBT500H's memory. This operation is referred to as MIDI Bulk In.

- * The device number becomes the MIDI receive channel number (→ pg. 15). When the MIDI receive channel is set to "ALL" (Omni ON), the channel is set to 1. When set to "oFF" (OFF) data will not be received.
- * "Ld" appears on the display while receiving MIDI Bulk data.

● Sending/Receiving MIDI Data Between Two BBT500Hs

The MIDI Bulk In or MIDI Bulk Out operations can be used to copy memory or Utility Setup data in one BBT500H to another BBT500H.

● Restoring the Factory Presets

This operation clears the contents of the BBT500H's memory 1-5 and restores all parameters to their factory preset settings. While holding the [MANUAL] switch and Memory Switch [5], switch the POWER switch ON.

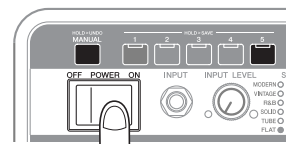

Attaching the Rack Mount Adaptor

Attach the supplied rack mount adaptor lets you install the BBT500H in a standard 19-inch rack.

1. Remove the two screws (A) on the side of the device and remove the carrying handle set.
2. Remove the two screws (B) on the side of the device.
3. Attach the supplied rack mount adaptor to the device using the three supplied screws (C).

* Never use any screws other than the supplied screws (C). Using any other screws can result in damage.

4. In the same manner, attach the other supplied rack mount adaptor to the opposite side of the device.

5. Keep the leftover screws (A, B) in a safe place for future use.

* Make sure you don't over-tighten the screws when reattaching the carrying handle to the device. Doing so can result in damage to the carrying handle.

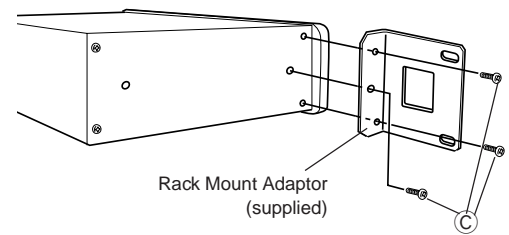
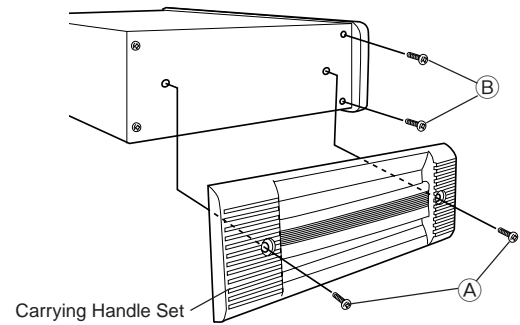

Air Flow

The device utilizes a forced air cooling system, which cools the interior of the unit by drawing air through the front intake by the fan, which push the air out the back.

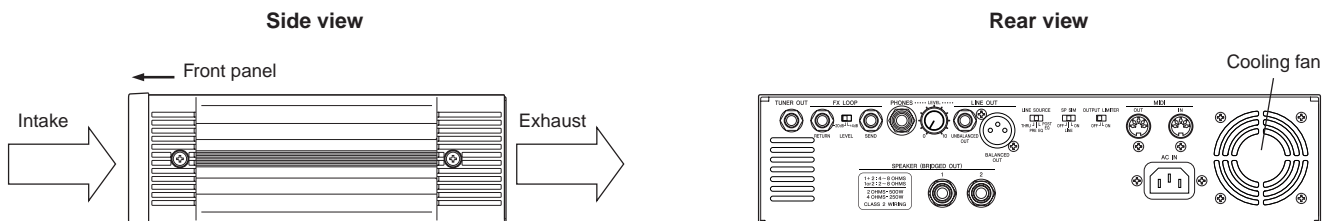

● Attaching the Clamp Filter (For U.S. and Canadian models only)

To protect against electromagnetic waves, attach the supplied Clamp Filters to the cable connecting the bass guitar to the amplifier's INPUT jack, and the cables connecting the amplifier's SPEAKER 1, 2 jacks to the speakers.

* When attaching the clamp filter, wrap the cable once around the clamp filter as close to the BBT500H unit as possible.

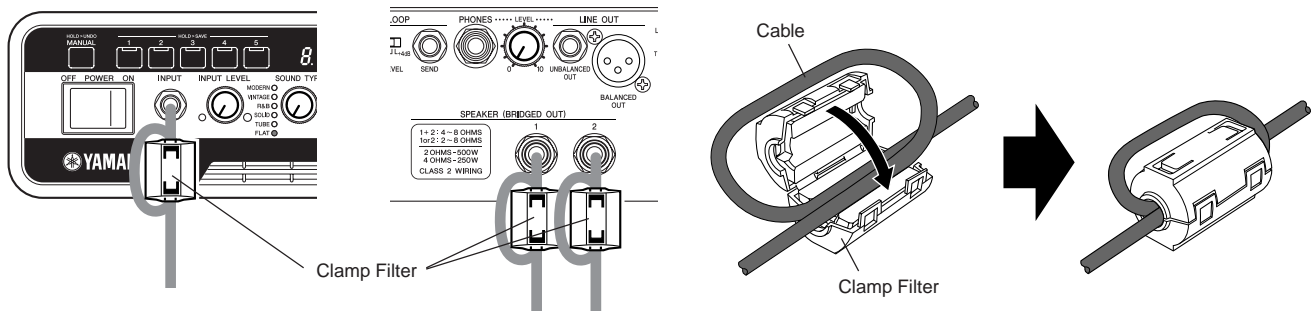

Error Messages

If an error occurs during operation, one of the following error message numbers will appear on the display.

E 1: MIDI Receive Buffer Full

CAUSE: Too much MIDI data is being received by the BBT500H at one time.

SOLUTION: Try reducing the amount of data being sent or, break the data into smaller blocks.

E 2: Communication Error.

CAUSE: An abnormality is detected during MIDI communications.

SOLUTION: Check all connections, etc. and try again.

E 3: Bulk Receive Check Sum Error.

CAUSE: The check sum does not match the received MIDI bulk data.

SOLUTION: Check all connections and data, and try again.

E 4: MIDI Receive Data Abnormality.

CAUSE: An abnormality is detected in the received MIDI data.

SOLUTION: Check all connections and data, and try again.

Troubleshooting

• No Sound

- Is the power cord properly connected to the device?
- Is the volume turned up on the instrument connected to the INPUT jack?
- Are the INPUT LEVEL, GAIN, MASTER, OUTPUT control knobs set to "0"?
- Check the Effect Loop's BLEND setting (Compressor Mode: TREBLE control knob). Unless an external effector is connected to the device, raising the BLEND control will result in lowering the original sound. If the BLEND control is set to "100", the original sound will not be produced.

• Sound output is low

- Is the volume turned up on the instrument connected to the INPUT jack?
- Are the INPUT LEVEL, GAIN, MASTER, OUTPUT control knobs turned up?
- Check the Effect Loop's BLEND setting (Compressor Mode: TREBLE control knob). Unless an external effector is connected to the device, raising the BLEND control will result in lowering the original sound. If the BLEND control is set to "100", the original sound will not be produced.
- Check the Compressor setting. A low Threshold setting or a high Ratio setting will result in a lowered the output signal level. Also, a long release setting or low Compressor Gain setting will result in a lowered output signal level.

Specifications

Power Amplifier Section

Class-D power amplifier circuitry
Output 500W/2Ω

Preamplifier Section

All digital signal processing
Sound Type: 11 Presets
5-Band Semi Parametric Tone Controls (Variable Frequencies)
Parametric Equalizer (PEQ, F, G, Q)

Effect Section

| | |
|--------------------------|---|
| Compressor | RATIO, THRSLED, ATTACK, RELEASE, C. GAIN, KNEE |
| Limiter | ON/OFF (SPEAKER, LINE OUT) |
| Noise Gate | N. GATE |
| Crossover Filter | LPF/HPF, Cutoff Frequency |
| Speaker Simulator | ON/LINE/OFF (SPEAKER, LINE OUT) |

Effect Loop

Monaural Send/Return, Level Switch (-20dB/+4dB), Effect Blend Control

User Memory

5 User Memory (Sound Type, Amp Settings, Compressor, Effect Blend)

MIDI Functions

| | |
|-----------------|---|
| Receive | Program Change, Control Change, Bulk In |
| Transmit | Program Change, Control Change, Bulk Out, Merge Out |

Controllers/Switches

| | |
|--------------------|---------------------------------------|
| Front Panel | Control Knobs x 11, Push Switches x 7 |
| Rear Panel | Control Knob x1, Slide Switches x4 |

Displays

Push Switch LED x5
Sound Type LED x11
7-Segment LED x3 Digit
Input Level LED x2 (Green, Red)

Connections

INPUT: Standard Monaural Phone Jack
SPEAKER 1, 2: Standard Monaural Phone Jack
PHONES: Standard Stereo Phone Jack
LINE OUT (UNBALANCED OUT): Standard Monaural Phone Jack
LINE OUT (BALANCED OUT): XLR Jack
FX LOOP (SEND/RETURN): Standard Monaural Phone Jack
TUNER OUT: Standard Monaural Phone Jack
MIDI IN, MIDI OUT: 5-pin DIN jack

A/D Conversion

24 bit

D/A Conversion

24 bit

Sampling Frequency

48kHz

Input Level/Impedance

INPUT: -37dBm (thru)/1MΩ
FX LOOP RETURN: -20dBm/220kΩ, +4dBm/220kΩ

Output Level/Impedance

SPEAKER (BRIDGED OUT): 500W RMS/2Ω, 250W RMS/4Ω
LINE OUT (UNBALANCED OUT): +4dBm/10kΩ
LINE OUT (BALANCED OUT): +4dBm/600Ω
FX LOOP SEND: -20dBm/100kΩ, +4dBm/100kΩ

Power Requirements

U.S. and Canadian models : 120V, 60Hz
General model : 230V, 50-60Hz

Power Consumption

130W

Dimensions (W x H x D)

378 x 88 x 265 mm (14-7/8" x 3-7/16" x 10-7/16")

Weight

U.S. and Canadian models : 4.7 kg (10 lbs. 6 oz)
General model : 5.2 kg (11 lbs. 7 oz)

Accessories

Power Cable
Rack Mount Adaptors X2
Rack Mount Adaptor Screws X6
Owner's Manual (this booklet)
Clamp Filters X3 (U.S. and Canadian models only)

* Design and specifications may change without notice due to improvements.

| Function ... | Transmitted | Recognized | Remarks |
|--------------------------|-------------|-------------------------|------------------|
| Basic Default | : x | : 1 - 16, off | : memorized |
| Channel Changed | : x | : 1 - 16, off | : |
| Mode Default | : x | : 1,3 | : memorized |
| Mode Messages | : x | : x | : |
| Mode Altered | : ***** | : x | : |
| Note | : x | : x | : |
| Note Number : True voice | : ***** | : x | : |
| Velocity Note ON | : x | : x | : |
| Velocity Note OFF | : x | : x | : |
| After Key's | : x | : x | : |
| Touch Ch's | : x | : x | : |
| Pitch Bender | : x | : x | : |
| 0 - 6 | : x | : x | : |
| 7 | : x | : o | : Main Volume |
| 8 - 127 | : x | : x | : |
| Control | : | : | : |
| Change | : | : | : |
| Prog | : x | : o 0 - 127 | : Program Change |
| Change : True # | : ***** | : | : Number 1-128 |
| System Exclusive | : o | : o | : Bulk Dump |
| System : Song Pos. | : x | : x | : |
| System : Song Sel. | : x | : x | : |
| common : Tune | : x | : x | : |
| System :Clock | : x | : x | : |
| Real Time :Commands | : x | : x | : |
| Aux :All Sound OFF | : x | : x | : |
| Aux :Reset All Cntrls | : x | : x | : |
| Aux :Local ON/OFF | : x | : x | : |
| Aux :All Notes OFF | : x | : x | : |
| Mes- :Active Sense | : o | : x | : |
| sages:Reset | : x | : x | : |
| Mode 1 : OMNI ON, POLY | | Mode 2 : OMNI ON, MONO | o : Yes |
| Mode 3 : OMNI OFF, POLY | | Mode 4 : OMNI OFF, MONO | x : No |

