



RX-V363

AV Receiver

OWNER'S MANUAL

IMPORTANT SAFETY INSTRUCTIONS

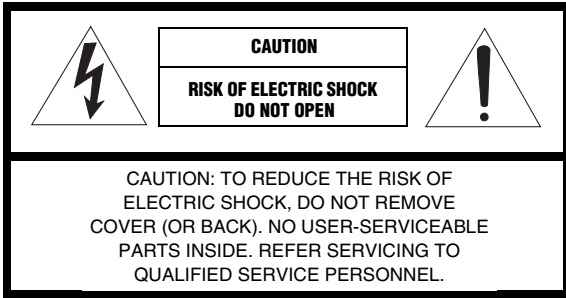

• Explanation of Graphical Symbols



The lightning flash with arrowhead symbol, within an equilateral triangle, is intended to alert you to the presence of uninsulated “dangerous voltage” within the product’s enclosure that may be of sufficient magnitude to constitute a risk of electric shock to persons.



The exclamation point within an equilateral triangle is intended to alert you to the presence of important operating and maintenance (servicing) instructions in the literature accompanying the appliance.

- 1 Read Instructions – All the safety and operating instructions should be read before the product is operated.
- 2 Retain Instructions – The safety and operating instructions should be retained for future reference.
- 3 Heed Warnings – All warnings on the product and in the operating instructions should be adhered to.
- 4 Follow Instructions – All operating and use instructions should be followed.
- 5 Cleaning – Unplug this product from the wall outlet before cleaning. Do not use liquid cleaners or aerosol cleaners.
- 6 Attachments – Do not use attachments not recommended by the product manufacturer as they may cause hazards.
- 7 Water and Moisture – Do not use this product near water – for example, near a bath tub, wash bowl, kitchen sink, or laundry tub; in a wet basement; or near a swimming pool; and the like.
- 8 Accessories – Do not place this product on an unstable cart, stand, tripod, bracket, or table. The product may fall, causing serious injury to a child or adult, and serious damage to the product. Use only with a cart, stand, tripod, bracket, or table recommended by the manufacturer, or sold with the product. Any mounting of the product should follow the manufacturer’s instructions, and should use a mounting accessory recommended by the manufacturer.
- 9 A product and cart combination should be moved with care. Quick stops, excessive force, and uneven surfaces may cause the product and cart combination to overturn.



- 10 Ventilation – Slots and openings in the cabinet are provided for ventilation and to ensure reliable operation of the product and to protect it from overheating, and these openings must not be blocked or covered. The openings should never be blocked by placing the product on a bed, sofa, rug, or other similar surface. This product should not be placed in a built-in installation such as a bookcase or rack unless proper ventilation is provided or the manufacturer’s instructions have been adhered to.
- 11 Power Sources – This product should be operated only from the type of power source indicated on the marking label. If you are not sure of the type of power supply to your home, consult your product dealer or local power company. For products intended to operate from battery power, or other sources, refer to the operating instructions.
- 12 Grounding or Polarization – This product may be equipped with a polarized alternating current line plug (a plug having one blade wider than the other). This plug will fit into the power outlet only one way. This is a safety feature. If you are unable to insert the plug fully into the outlet, try reversing the plug. If the plug should still fail to fit, contact your electrician to replace your obsolete outlet. Do not defeat the safety purpose of the polarized plug.
- 13 Power-Cord Protection – Power-supply cords should be routed so that they are not likely to be walked on or pinched by items placed upon or against them, paying particular attention to cords at plugs, convenience receptacles, and the point where they exit from the product.
- 14 Lightning – For added protection for this product during a lightning storm, or when it is left unattended and unused for long periods of time, unplug it from the wall outlet and disconnect the antenna or cable system. This will prevent damage to the product due to lightning and power-line surges.
- 15 Power Lines – An outside antenna system should not be located in the vicinity of overhead power lines or other electric light or power circuits, or where it can fall into such power lines or circuits. When installing an outside antenna system, extreme care should be taken to keep from touching such power lines or circuits as contact with them might be fatal.
- 16 Overloading – Do not overload wall outlets, extension cords, or integral convenience receptacles as this can result in a risk of fire or electric shock.
- 17 Object and Liquid Entry – Never push objects of any kind into this product through openings as they may touch dangerous voltage points or short-out parts that could result in a fire or electric shock. Never spill liquid of any kind on the product.
- 18 Servicing – Do not attempt to service this product yourself as opening or removing covers may expose you to dangerous voltage or other hazards. Refer all servicing to qualified service personnel.
- 19 Damage Requiring Service – Unplug this product from the wall outlet and refer servicing to qualified service personnel under the following conditions:
 - a) When the power-supply cord or plug is damaged,
 - b) If liquid has been spilled, or objects have fallen into the product,
 - c) If the product has been exposed to rain or water,

- d) If the product does not operate normally by following the operating instructions. Adjust only those controls that are covered by the operating instructions as an improper adjustment of other controls may result in damage and will often require extensive work by a qualified technician to restore the product to its normal operation,
 - e) If the product has been dropped or damaged in any way, and
 - f) When the product exhibits a distinct change in performance - this indicates a need for service.
- 20 Replacement Parts** – When replacement parts are required, be sure the service technician has used replacement parts specified by the manufacturer or have the same characteristics as the original part. Unauthorized substitutions may result in fire, electric shock, or other hazards.
- 21 Safety Check** – Upon completion of any service or repairs to this product, ask the service technician to perform safety checks to determine that the product is in proper operating condition.
- 22 Wall or Ceiling Mounting** – The unit should be mounted to a wall or ceiling only as recommended by the manufacturer.
- 23 Heat** – The product should be situated away from heat sources such as radiators, heat registers, stoves, or other products (including amplifiers) that produce heat.

- 24 Outdoor Antenna Grounding** – If an outside antenna or cable system is connected to the product, be sure the antenna or cable system is grounded so as to provide some protection against voltage surges and built-up static charges. Article 810 of the National Electrical Code, ANSI/NFPA 70, provides information with regard to proper grounding of the mast and supporting structure, grounding of the lead-in wire to an antenna discharge unit, size of grounding conductors, location of antenna discharge unit, connection to grounding electrodes, and requirements for the grounding electrode.

EXAMPLE OF ANTENNA GROUNDING

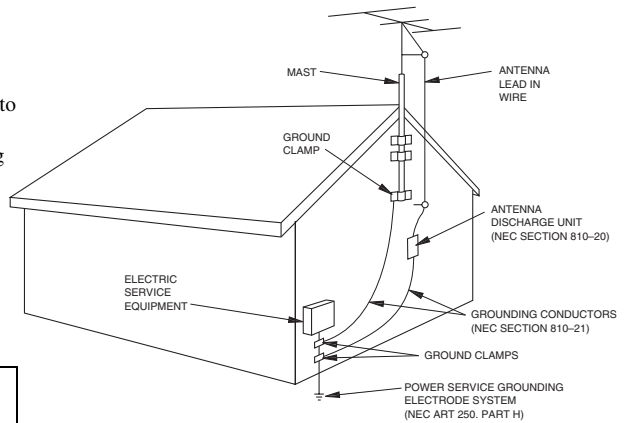

NEC – NATIONAL ELECTRICAL CODE

Note to CATV system installer:

This reminder is provided to call the CATV system installer’s attention to Article 820-40 of the NEC that provides guidelines for proper grounding and, in particular, specifies that the cable ground shall be connected to the grounding system of the building, as close to the point of cable entry as practical.

FCC INFORMATION (for US customers)

1 IMPORTANT NOTICE: DO NOT MODIFY THIS UNIT!

This product, when installed as indicated in the instructions contained in this manual, meets FCC requirements. Modifications not expressly approved by Yamaha may void your authority, granted by the FCC, to use the product.

- 2 IMPORTANT:** When connecting this product to accessories and/or another product use only high quality shielded cables. Cable/s supplied with this product **MUST** be used. Follow all installation instructions. Failure to follow instructions could void your FCC authorization to use this product in the USA.

- 3 NOTE:** This product has been tested and found to comply with the requirements listed in FCC Regulations, Part 15 for Class “B” digital devices. Compliance with these requirements provides a reasonable level of assurance that your use of this product in a residential environment will not result in harmful interference with other electronic devices.

This equipment generates/uses radio frequencies and, if not installed and used according to the instructions found in the users manual, may cause interference harmful to the operation of other electronic devices.

Compliance with FCC regulations does not guarantee that interference will not occur in all installations. If this product is found to be the source of interference, which can be determined by turning the unit “OFF” and “ON”, please try to eliminate the problem by using one of the following measures:

Relocate either this product or the device that is being affected by the interference.

Utilize power outlets that are on different branch (circuit breaker or fuse) circuits or install AC line filter/s.

In the case of radio or TV interference, relocate/reorient the antenna. If the antenna lead-in is 300 ohm ribbon lead, change the lead-in to coaxial type cable.

If these corrective measures do not produce satisfactory results, please contact the local retailer authorized to distribute this type of product. If you can not locate the appropriate retailer, please contact Yamaha Electronics Corp., U.S.A. 6660 Orangethorpe Ave., Buena Park, CA 90620.

The above statements apply **ONLY** to those products distributed by Yamaha Corporation of America or its subsidiaries.

Caution: Read this before operating your unit.

- 1 To assure the finest performance, please read this manual carefully. Keep it in a safe place for future reference.
- 2 Install this sound system in a well ventilated, cool, dry, clean place – away from direct sunlight, heat sources, vibration, dust, moisture, and/or cold. Allow ventilation space of at least 30 cm on the top, 20 cm on the left and right, and 20 cm on the back of this unit.
- 3 Locate this unit away from other electrical appliances, motors, or transformers to avoid humming sounds.
- 4 Do not expose this unit to sudden temperature changes from cold to hot, and do not locate this unit in an environment with high humidity (i.e. a room with a humidifier) to prevent condensation inside this unit, which may cause an electrical shock, fire, damage to this unit, and/or personal injury.
- 5 Avoid installing this unit where foreign object may fall onto this unit and/or this unit may be exposed to liquid dripping or splashing. On the top of this unit, do not place:
 - Other components, as they may cause damage and/or discoloration on the surface of this unit.
 - Burning objects (i.e. candles), as they may cause fire, damage to this unit, and/or personal injury.
 - Containers with liquid in them, as they may fall and liquid may cause electrical shock to the user and/or damage to this unit.
- 6 Do not cover this unit with a newspaper, tablecloth, curtain, etc. in order not to obstruct heat radiation. If the temperature inside this unit rises, it may cause fire, damage to this unit, and/or personal injury.
- 7 Do not plug in this unit to a wall outlet until all connections are complete.
- 8 Do not operate this unit upside-down. It may overheat, possibly causing damage.
- 9 Do not use force on switches, knobs and/or cords.
- 10 When disconnecting the power cable from the wall outlet, grasp the plug; do not pull the cord.
- 11 Do not clean this unit with chemical solvents; this might damage the finish. Use a clean, dry cloth.
- 12 Only voltage specified on this unit must be used. Using this unit with a higher voltage than specified is dangerous and may cause fire, damage to this unit, and/or personal injury. Yamaha will not be held responsible for any damage resulting from use of this unit with a voltage other than specified.
- 13 To prevent damage by lightning, keep the power cord and outdoor antennas disconnected from a wall outlet or the unit during a lightning storm.
- 14 Do not attempt to modify or fix this unit. Contact qualified Yamaha service personnel when any service is needed. The cabinet should never be opened for any reasons.
- 15 When not planning to use this unit for long periods of time (i.e. vacation), disconnect the AC power plug from the wall outlet.
- 16 Install this unit near the AC outlet and where the AC power plug can be reached easily.
- 17 Be sure to read the “Troubleshooting” section on common operating errors before concluding that this unit is faulty.
- 18 Before moving this unit, press **(A)STANDBY/ON** to set this unit in the standby mode, and disconnect the AC power plug from the wall outlet.
- 19 **VOLTAGE SELECTOR** (Asia and General models only)
The VOLTAGE SELECTOR on the rear panel of this unit must be set for your local main voltage BEFORE plugging into the AC wall outlet.
Voltages are 110–120/220–240 V AC, 50/60 Hz.
- 20 The batteries shall not be exposed to excessive heat such as sunshine, fire or like.
- 21 Excessive sound pressure from earphones and headphones can cause hearing loss.

WARNING

TO REDUCE THE RISK OF FIRE OR ELECTRIC SHOCK, DO NOT EXPOSE THIS UNIT TO RAIN OR MOISTURE.

This unit is not disconnected from the AC power source as long as it is connected to the wall outlet, even if this unit itself is turned off by **(A)STANDBY/ON**. This state is called the standby mode. In this state, this unit is designed to consume a very small quantity of power.

FOR CANADIAN CUSTOMERS

To prevent electric shock, match wide blade of plug to wide slot and fully insert.
This Class B digital apparatus complies with Canadian ICES-003.

POUR LES CONSOMMATEURS CANADIENS

Pour éviter les chocs électriques, introduire la lame la plus large de la fiche dans la borne correspondante de la prise et pousser jusqu'au fond.
Cet appareil numérique de la classe B est conforme à la norme NMB-003 du Canada.

IMPORTANT

Please record the serial number of this unit in the space below.

MODEL:

Serial No.:

The serial number is located on the rear of the unit.

Retain this Owner's Manual in a safe place for future reference.

Contents

INTRODUCTION

Features	2
Getting started	3
Quick start guide	4
Preparation: Check the items	4
Step 1: Set up your speakers	5
Step 2: Connect your DVD player and other components	6
Step 3: Turn on the power and press SCENE 1 button	7
What do you want to do with this unit?	8

PREPARATION

Connections	9
Rear panel	9
Placing speakers	10
Connecting speakers	11
Setting the speaker impedance (U.S.A. and Canada models only)	12
Information on jacks and cable plugs	13
Information on HDMI™	14
Connecting video components	15
Connecting audio components	17
Connecting a Yamaha iPod™ universal dock and Bluetooth™ adapter	18
Connecting to the VIDEO AUX jacks on the front panel	18
Connecting the FM and AM antennas	19
Connecting the power cable	19
Turning on and off the power	19
Front panel display	20
Basic setup	22

BASIC OPERATION

Selecting the SCENE templates	24
Selecting the desired SCENE template	24
Creating your original SCENE templates	27
Using remote control on the SCENE feature	28
Playback	29
Basic operations	29
Additional operations	30
Sound field programs	34
Sound field program descriptions	34
FM/AM tuning	37
Automatic tuning	37
Manual tuning	37
Automatic preset tuning	38
Manual preset tuning	38
Selecting preset stations	39
Exchanging preset stations	39
Using iPod™	40
Controls and functions for iPod™	40
Using Bluetooth™ components	41
Pairing the Bluetooth™ adapter and your Bluetooth™ component	41
Playback of the Bluetooth™ component	41
Recording	42

ADVANCED OPERATION

Set menu	43
Using set menu	44
1 SOUND MENU	45
2 INPUT MENU	48
3 OPTION MENU	50
Remote control features	51
Controlling this unit, a TV, or other components	51
Setting remote control codes	53
Advanced setup	54

ADDITIONAL INFORMATION





Troubleshooting	55
Glossary	60
Specifications	62
Index	63

APPENDIX

(at the end of this manual)

Front panel	i
Remote control	ii
List of remote control codes	iii

About this manual

-  indicates a tip for your operation.
- Some operations can be performed by using either the buttons on the front panel or the ones on the remote control. In case the button names differ between the front panel and the remote control, the button name on the remote control is given in parentheses.
- This manual is printed prior to production. Design and specifications are subject to change in part as a result of improvements, etc. In case of differences between the manual and product, the product has priority.
- “STANDBY/ON” or “DVD” (example) indicates the name of the parts on the front panel or the remote control. Refer to the attached sheet or the pages at the end of this manual for the information about each position of the parts.
- The symbol “” with page number(s) indicates the corresponding reference page(s).

Features

Built-in 5-channel power amplifier

- ◆ Minimum RMS output power

[U.S.A. and Canada models]
(1 kHz, 0.9% THD, 8 Ω)

Front: 100 W/ch

Center: 100 W

Surround: 100 W/ch

[Other models]

(1 kHz, 0.9% THD, 6 Ω)

Front: 100 W/ch

Center: 100 W

Surround: 100 W/ch

SCENE select function

- ◆ Preset SCENE templates for various situations
- ◆ SCENE template customizing capability

Decoders and DSP circuits

- ◆ Proprietary Yamaha technology for the creation of multi-channel surround sound
- ◆ Compressed Music Enhancer mode
- ◆ Dolby Digital decoder
- ◆ Dolby Pro Logic/Dolby Pro Logic II decoder
- ◆ DTS decoder
- ◆ Virtual CINEMA DSP
- ◆ SILENT CINEMA™



Manufactured under license from Dolby Laboratories.

“Dolby”, “Pro Logic”, and the double-D symbol are trademarks of Dolby Laboratories.

SILENT™
CINEMA

“SILENT CINEMA” is a trademark of Yamaha Corporation.

HDMI

“HDMI”, the “HDMI” logo and “High-Definition Multimedia Interface” are trademarks or registered trademarks of HDMI Licensing LLC.

Sophisticated FM/AM tuner

- ◆ 40-station random and direct preset tuning
- ◆ Automatic preset tuning

HDMI (High-Definition Multimedia Interface)

- ◆ HDMI interface for standard, enhanced or high-definition video (includes 1080p video signal transmission)

DOCK terminal

- ◆ DOCK terminal to connect a Yamaha iPod universal dock (such as YDS-10, sold separately) or Bluetooth adapter (such as YBA-10, sold separately).

Other features

- ◆ 192-kHz/24-bit D/A converter
- ◆ 6 additional input jacks for discrete multi-channel input
- ◆ Component video input/output capability (3 COMPONENT VIDEO INs and 1 MONITOR OUT)
- ◆ iPod controlling capability
- ◆ Sleep timer
- ◆ Cinema and music night listening modes
- ◆ Remote control with preset remote control codes

iPod™

“iPod” is a trademark of Apple Inc., registered in the U.S. and other countries.

Bluetooth™

Bluetooth is a registered trademark of the Bluetooth SIG and is used by Yamaha in accordance with a license agreement.



“DTS” and “DTS Digital Surround” are registered trademarks of DTS, Inc.

We Want You Listening For A Lifetime

Yamaha and the Electronic Industries Association’s Consumer Electronics Group want you to get the most out of your equipment by playing it at a safe level. One that lets the sound come through loud and clear without annoying blaring or distortion – and, most importantly, without affecting your sensitive hearing.

Since hearing damage from loud sounds is often undetectable until it is too late, Yamaha and the Electronic Industries Association’s Consumer Electronics Group recommend you to avoid prolonged exposure from excessive volume levels.



Getting started

■ Checking the supplied accessories

Check that you received all of the following parts.

- ❑ Remote control
- ❑ Batteries (2) (AAA, R03, UM-4)
- ❑ AM loop antenna
- ❑ Indoor FM antenna

■ VOLTAGE SELECTOR (Asia and General models only)

Caution

The VOLTAGE SELECTOR on the rear panel of this unit must be set for your local voltage BEFORE plugging the power cable into the AC wall outlet. Improper setting of the VOLTAGE SELECTOR may cause damage to this unit and create a potential fire hazard.

Select the switch position (upper or lower) according to your local voltage using a straight slot screwdriver.

Voltages are 110-120/220-240 V AC, 50/60 Hz.

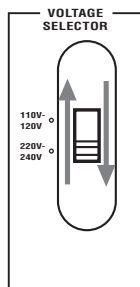

■ Installing batteries in the remote control

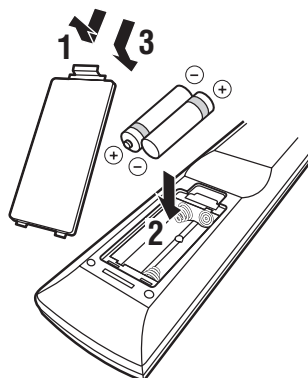

1 Take off the battery compartment cover.

2 Insert the two supplied batteries (AAA, R03, UM-4) according to the polarity markings (+ and -) on the inside of the battery compartment.

3 Snap the battery compartment cover back into place.

Notes

- Change all of the batteries if you notice the following condition:
 - the operation range of the remote control decreases.
- Do not use an old battery and a new one together.
- Do not use different types of batteries (such as alkaline and manganese batteries) together. Read the packaging carefully as these different types of batteries may have the same shape and color.
- If the batteries have leaked, dispose of them immediately. Avoid touching the leaked material or letting it come into contact with clothing, etc. Clean the battery compartment thoroughly before installing new batteries.
- Do not throw away batteries with general house waste; dispose of them correctly in accordance with your local regulations.
- If the remote control is without batteries for more than 2 minutes, or if exhausted batteries remain in the remote control, the contents of the memory may be cleared. When the memory is cleared, insert new batteries and set up the remote control code.

Quick start guide

The following steps describe the easiest way to enjoy DVD movie playback in your home theater.

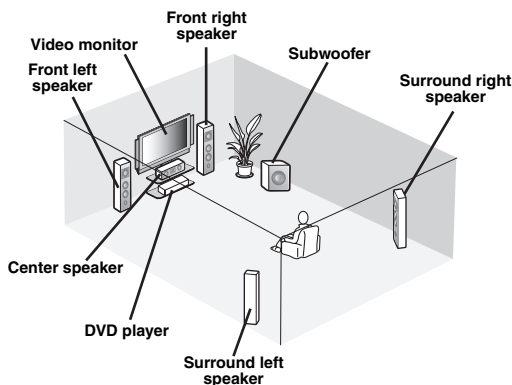

Step 1: Set up your speakers

P. 5

Step 2: Connect your DVD player and other components

P. 6

Step 3: Turn on the power and press SCENE 1 button

P. 7

Enjoy DVD playback!

Preparation: Check the items

Prepare the following items.

- Speakers**
 - Front speaker** x 2
 - Center speaker** x 1
 - Surround speaker** x 2Select magnetically shielded speakers. The minimum required speakers are two front speakers.
- Active subwoofer** x 1
- Select an active subwoofer equipped with an RCA input jack.
- Speaker cable** x 5
- Subwoofer cable** x 1
- Select a monaural RCA cable.
- DVD player** x 1
- Select DVD player equipped with coaxial digital audio output jack and composite video output jack.
- Video monitor** x 1
- Select a TV monitor, video monitor or projector equipped with a composite video input jack.
- Video cable** x 2
- Select an RCA composite video cable.
- Digital coaxial audio cable** x 1

Step 1: Set up your speakers

Place your speakers in the room and connect them to this unit.

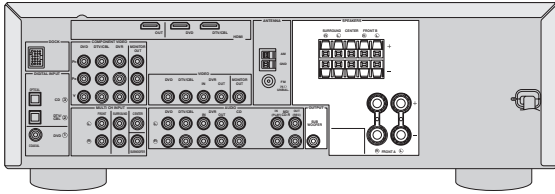

1 Place your speakers and subwoofer in the room.

2 Connect speaker cables to each speaker.

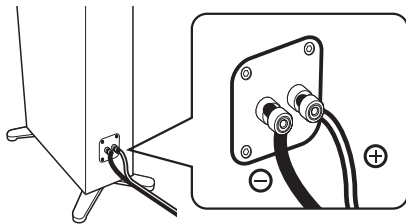

Cables are colored or shaped differently, perhaps with a stripe, groove or ridge. Connect the striped (grooved, etc.) cable to the “+” (red) terminals of your speaker. Connect the plain cable to the “-” (black) terminals.

3 Connect each speaker cable to the corresponding speaker terminal on this unit.

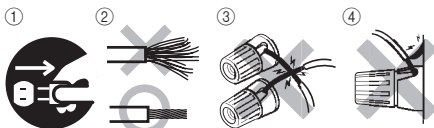

- ① Make sure that this unit and the subwoofer are unplugged from the AC wall outlets.
- ② Twist the exposed wires of the speaker cables together to prevent short circuits.
- ③ Do not let the bare speaker wires touch each other.
- ④ Do not let the bare speaker wires touch any metal part of this unit.

Be sure to connect the left channel (L), right channel (R), “+” (red) and “-” (black) properly.

Front speakers

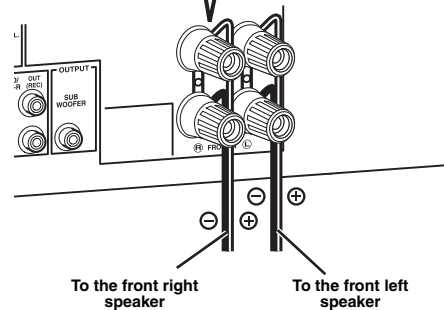
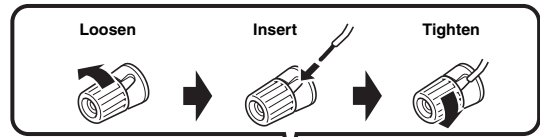

Center and surround speakers

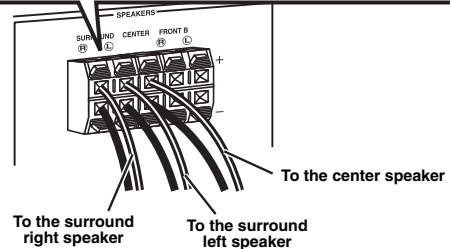
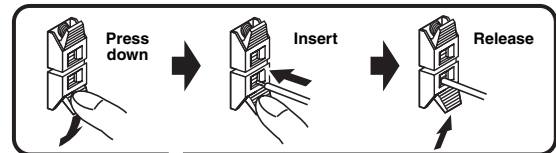

4 Connect the subwoofer cable to the input jack on the subwoofer and the SUBWOOFER OUTPUT jack on this unit.

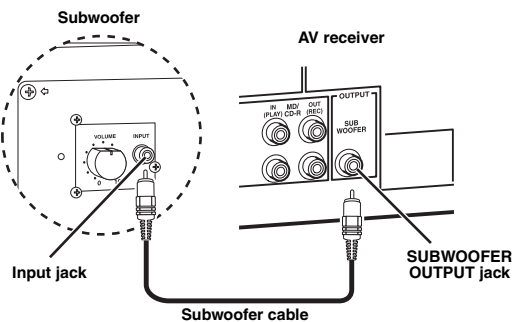

Step 2: Connect your DVD player and other components

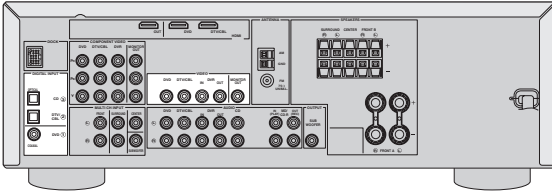

Make sure that this unit and the DVD player are unplugged from the AC wall outlets.

- 1 Connect the digital coaxial audio cable to the digital coaxial audio output jack on your DVD player and the DVD DIGITAL INPUT COAXIAL jack on this unit.

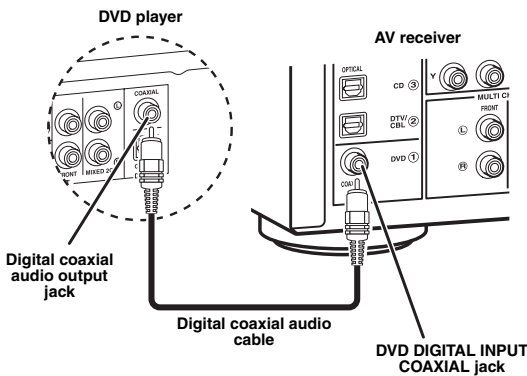

- 2 Connect the video cable to the composite video output jack on your DVD player and the DVD VIDEO jack on this unit.

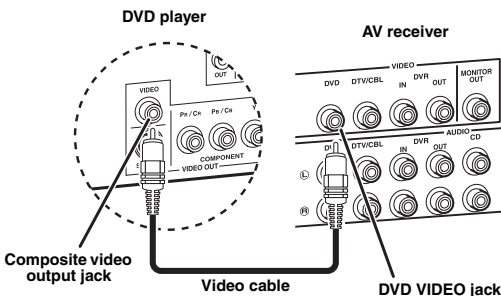

- 3 Connect the video cable to the video input jack on your video monitor and the VIDEO MONITOR OUT jack on this unit.

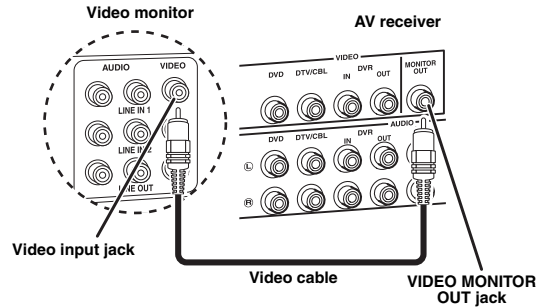

- 4 Connect the power plug of this unit and other components into the AC wall outlet.

■ For further connections

- Using the other kind of speaker combinations [P. 10](#)
- Connecting a video monitor and DVD player [P. 15](#)
- Connecting a cable TV/satellite tuner and DVD recorder [P. 15](#)
- Connecting to the HDMI jacks [P. 16](#)
- Connecting to the COMPONENT VIDEO jacks [P. 16](#)
- Using the VIDEO AUX jacks on the front panel [P. 18](#)
- Connecting a CD player and an MD recorder [P. 17](#)
- Connecting a DVD player via analog multi-channel audio connection [P. 17](#)
- Connecting an outdoor FM/AM antenna [P. 19](#)
- Connecting an iPod/Bluetooth dock [P. 18](#)

Step 3: Turn on the power and press SCENE 1 button

Check the type of the connected speakers.
If the speakers are 6 ohm speakers, set "SP IMP." to "6ΩMIN" before using this unit (see page 12).

1 Turn on the video monitor and then set the input source selector of the video monitor to this unit.

2 Press **(A) STANDBY/ON** on the front panel.

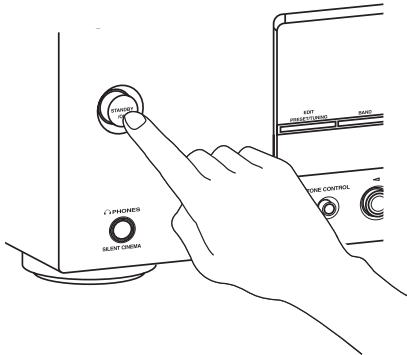

3 Press **(P) SCENE 1**.

"DVD Viewing" appears in the front panel display, and this unit automatically optimize own status for the DVD playback.

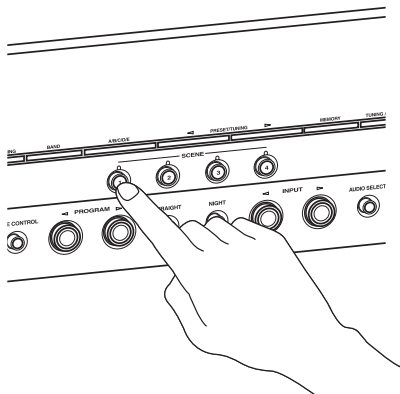

The indicator on the selected SCENE button lights up while this unit is in the SCENE mode.

4 Start playback of the desired DVD on your player.

5 Rotate **(H) VOLUME** to adjust the volume.

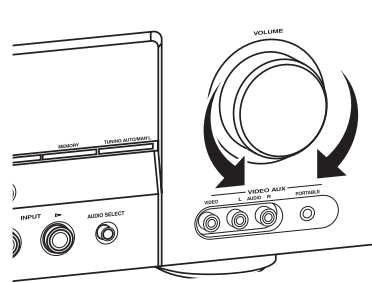

Note

When you change the input source or sound field program, the SCENE mode is deactivated and the indicator on the SCENE button turns off.

■ About SCENE function

Just by pressing one SCENE button, you can turn on this unit and recall your favorite input source and sound field program according to the SCENE template that has been assigned to the SCENE button. The SCENE templates are built combinations of input sources and sound field programs.



If you connect a Yamaha product that has capability of the SCENE control signals, this unit can automatically activate the component and start playback. Refer to the instruction manual of the DVD player for further information.

■ Using the other SCENE buttons

Default SCENE button	The name of the SCENE template and its description
SCENE 1	DVD Viewing – input source: DVD – sound field program: STRAIGHT For when you want to listen to a music disc from the connected DVD player as the background music for this room.
SCENE 2	Disc Listening – input source: DVD – sound field program: 5ch Stereo For when you want to listen to a music disc from the connected DVD player as the background music for this room.
SCENE 3	TV Viewing *1 – input source: DTV/CBL – sound field program: STRAIGHT For when you want to watch a TV program.
SCENE 4	Radio Listening *2, *3, *4 – input source: TUNER – sound field program: Music Enh. 5ch For when you want to listen to a music program from the FM radio station

Notes

- *1 You must connect a cable TV or a satellite tuner to this unit in advance. See page 16 for details.
- *2 You need to connect the supplied FM and AM antennas to this unit in advance. See page 19 for details.
- *3 You have to tune into the desired radio station. See pages 37 to 39 for the tuning information.
- *4 To achieve the best possible reception, orient the connected AM loop antenna, or adjust the position of the end of the indoor FM antenna.



If you cannot find the desired situation, you can select and change the assigned SCENE template for the SCENE buttons. See page 24 for details.

■ After using this unit...

Press **(A) STANDBY/ON** on the front panel to set this unit to the standby mode.

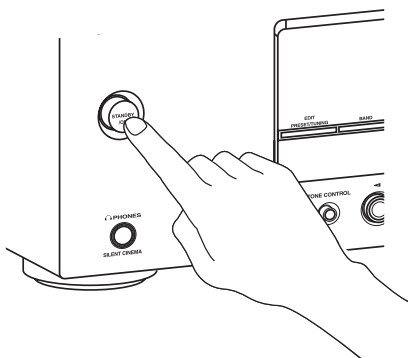

This unit is set to the standby mode. To turn on this unit from the standby mode, press **(A) STANDBY/ON** (or **(14) POWER**) on the front panel. See page 19 for details.

Note

In the standby mode, this unit consumes a small amount of power in order to receive infrared signals from the remote control.

What do you want to do with this unit?

■ Customizing the SCENE templates

- Using various SCENE templates

P. 24

■ Using various input sources

- Basic controls of this unit P. 29
- Enjoying FM/AM radio programs P. 37
- Using your iPod with this unit P. 40
- Using the Bluetooth component P. 41

■ Using various sound features

- Using various sound field programs

P. 34

■ Adjusting the parameters of this unit

- Optimizing the speaker parameters for your listening room (BASIC SETUP) P. 22
- Manually adjusting various parameters of this unit P. 43
- Setting the remote control P. 51
- Adjusting the advanced parameters P. 54

■ Additional features

- Automatically turning off this unit

P. 33

Connections

Rear panel

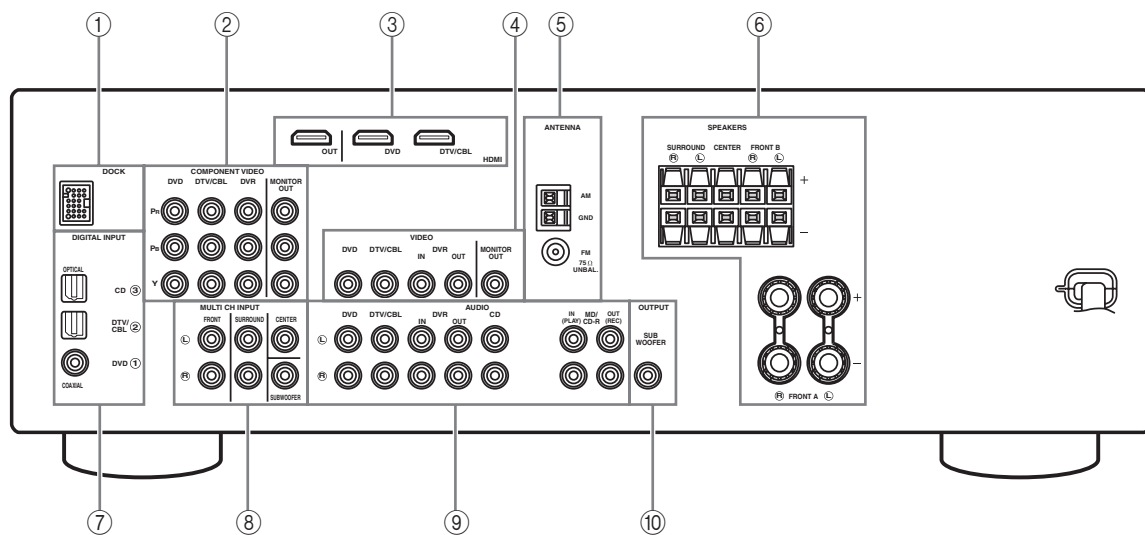

	Name	See page
①	DOCK terminal	18
②	COMPONENT VIDEO jacks	16
③	HDMI jacks	16
④	VIDEO jacks	15
⑤	ANTENNA terminals	19
⑥	SPEAKERS terminals	11
⑦	DIGITAL INPUT jacks	15, 17
⑧	MULTI CH INPUT jacks	17
⑨	AUDIO jacks	15, 17
⑩	SUBWOOFER OUTPUT jack	11

Placing speakers

The speaker layout below shows the speaker setting we recommend. You can use it to enjoy CINEMA DSP and multi-channel audio sources.

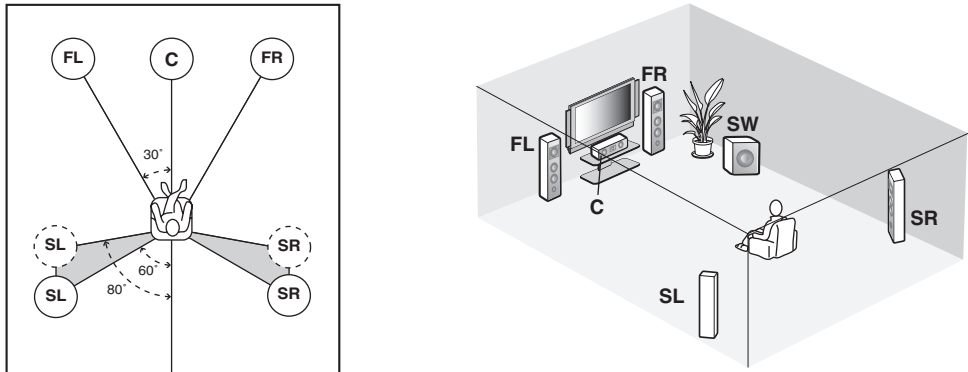

Front left and right speakers (FL and FR)

The front speakers are used for the main source sound plus effect sounds. Place these speakers at an equal distance from the ideal listening position. The distance of each speaker from each side of the video monitor should be the same.

Center speaker (C)

The center speaker is for the center channel sounds (dialog, vocals, etc.). If for some reason it is not practical to use a center speaker, you can do without it. Best results, however, are obtained with the full system.

Surround left and right speakers (SL and SR)

The surround speakers are used for effect and surround sounds.

Subwoofer (SW)

The use of a subwoofer with a built-in amplifier, such as the Yamaha Active Servo Processing Subwoofer System, is effective not only for reinforcing bass frequencies from any or all channels, but also for high fidelity sound reproduction of the LFE (low-frequency effect) channel included in Dolby Digital and DTS sources. The position of the subwoofer is not so critical, because low bass sounds are not highly directional. But it is better to place the subwoofer near the front speakers. Turn it slightly toward the center of the room to reduce wall reflections.

Connecting speakers

Be sure to connect the left channel (L), right channel (R), “+” (red) and “-” (black) properly. If the connections are faulty, this unit cannot reproduce the input sources accurately.

Caution

- Use speakers with the specified impedance shown on the rear panel of this unit.
- If you are to use 6 ohm speakers, be sure to set “SP IMP.” to “6ΩMIN” before using this unit (see page 12).
- Before connecting the speakers, make sure that the AC power plug is disconnected from the AC wall outlet.
- Do not let the bare speaker wires touch each other or let them touch any metal part of this unit. This could damage this unit and/or speakers.
- Use magnetically shielded speakers. If this type of speakers still creates the interference with the monitor, place the speakers away from the monitor.

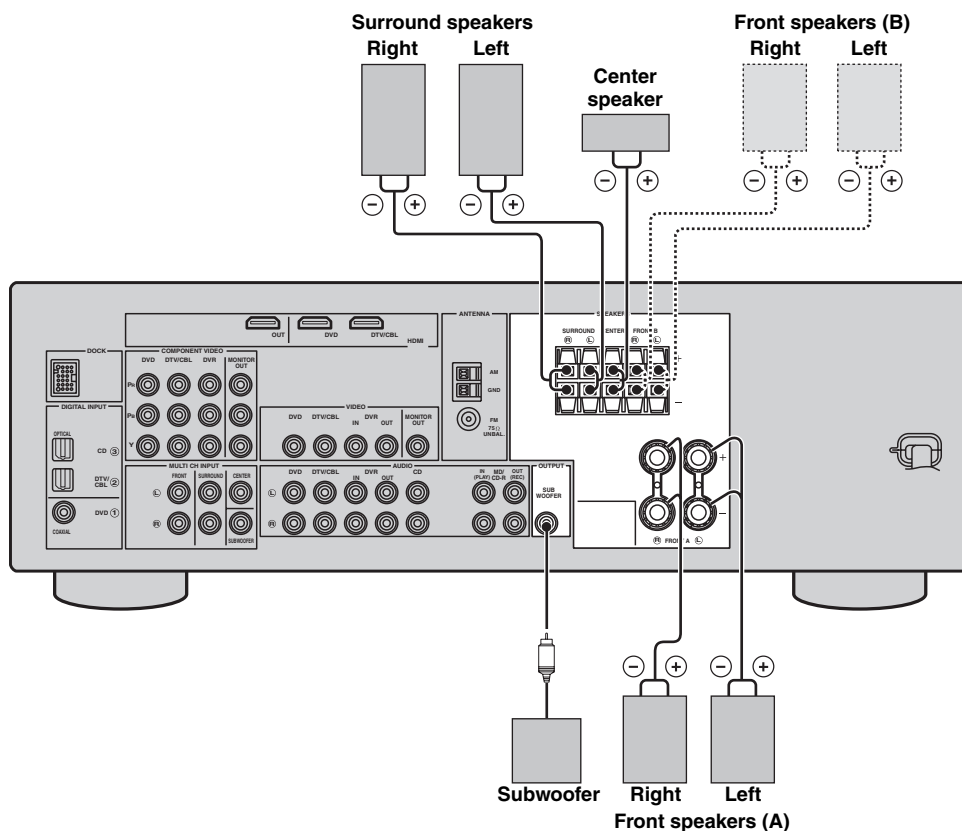

■ Before connecting to the SPEAKERS terminal

A speaker cord is actually a pair of insulated cables running side by side. Cables are colored or shaped differently, perhaps with a stripe, groove or ridges. Connect the striped (grooved, etc.) cable to the “+” (red) terminals of this unit and your speaker. Connect the plain cable to the “-” (black) terminals.

Remove approximately 10 mm (3/8”) of insulation from the end of each speaker cable and then twist the bare wires of the cable together to prevent short circuits.

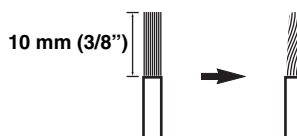

■ Connecting to the FRONT A terminals

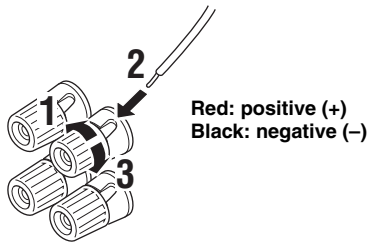

- 1 Loosen the knob.
- 2 Insert the bare end of the speaker wire into the slit on the terminal.
- 3 Tighten the knob to secure the wire.

Connecting the banana plug (except Europe, Russia, Korea, and Asia models)

The banana plug is a single-pole electrical connector widely used to terminate speaker cables. First, tighten the knob and then insert the banana plug connector into the end of the corresponding terminal.

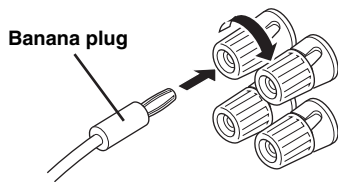

■ Connecting to the FRONT B, CENTER, and SURROUND terminals

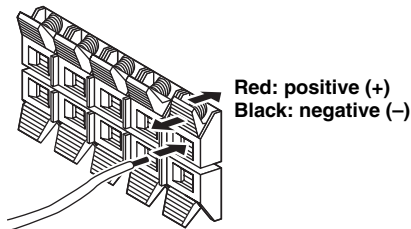

- 1 Press down the tab.
- 2 Insert the bare end of the speaker wire into the hole on the terminal.
- 3 Release the tab to secure the wire.

Setting the speaker impedance (U.S.A. and Canada models only)

Caution

If you are to use 6 ohm speakers, set "SP IMP." to "6ΩMIN" as follows BEFORE using this unit.

- 1 **Make sure this unit is turned off.**
See page 19 for details about turning on or off this unit.
- 2 Press and hold **Ⓜ TONE CONTROL** and then press **Ⓜ STANDBY/ON** to turn on this unit.
This unit turns on, and the advanced setup menu appears in the front panel display.
- 3 Press **Ⓚ PROGRAM </>** repeatedly to select "SP IMP."
The following display appears in the front panel display.

SP IMP.- 8ΩMIN

- 4 Press **Ⓛ STRAIGHT** repeatedly to select "6ΩMIN".
The following display appears in the front panel display.

SP IMP.- 6ΩMIN

- 5 Press **Ⓜ STANDBY/ON** to confirm your selection and set this unit to the standby mode.

Note

The setting you made is reflected next time you turn on this unit.

Information on jacks and cable plugs

Audio jacks and cable plugs

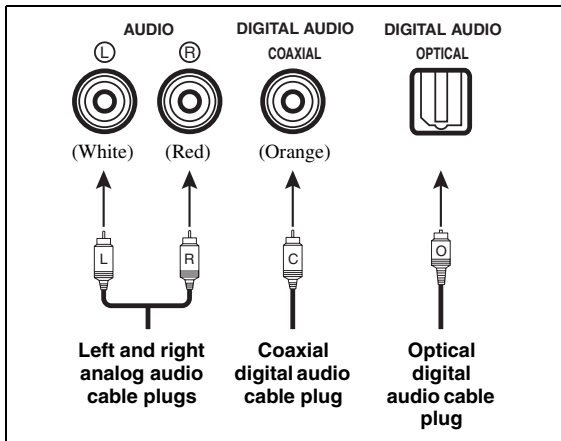

■ Audio jacks

This unit has three types of audio jacks. Connection depends on the availability of audio jacks on your other components.

AUDIO jacks

For conventional analog audio signals transmitted via left and right analog audio cables. Connect red plugs to the right jacks and white plugs to the left jacks.

DIGITAL AUDIO COAXIAL jacks

For digital audio signals transmitted via coaxial digital audio cables.

DIGITAL AUDIO OPTICAL jacks

For digital audio signals transmitted via optical digital audio cables.

Notes

- You can use the digital jacks to input PCM, Dolby Digital and DTS bitstreams. All digital input jacks are compatible with digital signals with up to 96 kHz of sampling frequency.
- This unit handles digital and analog signals independently. Thus audio signals input at the digital jacks are not output at the analog AUDIO OUT (REC) jacks.

Video jacks and cable plugs

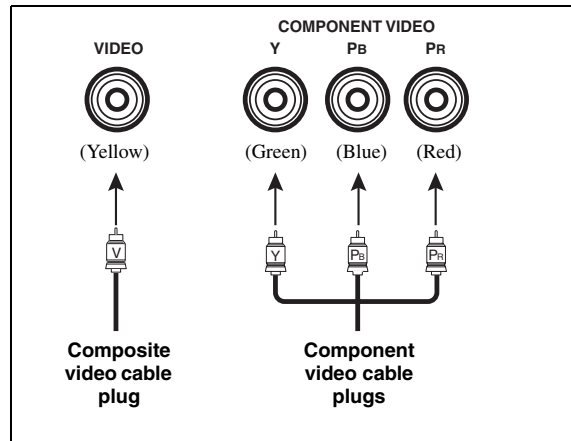

■ Video jacks

This unit has two types of video jacks. Connection depends on the availability of input jacks on your video monitor.

VIDEO jacks

For conventional composite video signals transmitted via composite video cables.

COMPONENT VIDEO jacks

For component signals, separated into the luminance (Y) and chrominance (P_B, P_R) video signals transmitted on separate wires of component video cables.

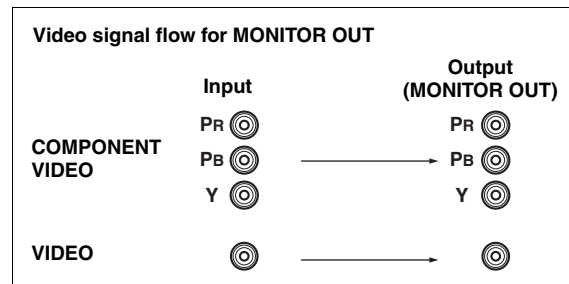

Information on HDMI™

Audio signals input at the HDMI jack are not output from any speaker terminals but output from the connected video monitor.

To enjoy the sound from speakers connected to this unit,

- make an analog or digital connection besides the HDMI connection (see page 16).
- mute the volume of the connected video monitor.

You can play back pictures by connecting your video monitor and video source component to this unit using HDMI connections.

At that time, audio/video signals output from the connected component (such as DVD player etc.) are output to the connected video monitor only when this unit is turned on and set to the input source (DVD or DTV/CBL).

Furthermore, available audio/video signals depend on the specification of the connected video monitor. Refer to the instruction manual of each connected component.

■ HDMI jack and cable plug

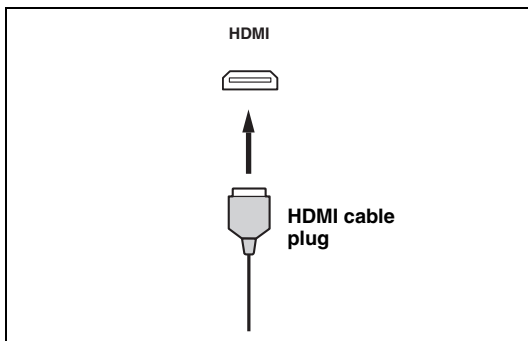

- We recommend using an HDMI cable shorter than 5 meters (16 feet) with the HDMI logo printed on it.
- Use a conversion cable (HDMI jack ↔ DVI-D jack) to connect this unit to other DVI components.

Connecting video components



You can also connect a video monitor, DVD player, digital TV, and cable TV to this unit using the HDMI or COMPONENT VIDEO connection (see page 16).



Make sure that this unit and other components are unplugged from the AC wall outlets.

■ Connecting a video monitor and a DVD player

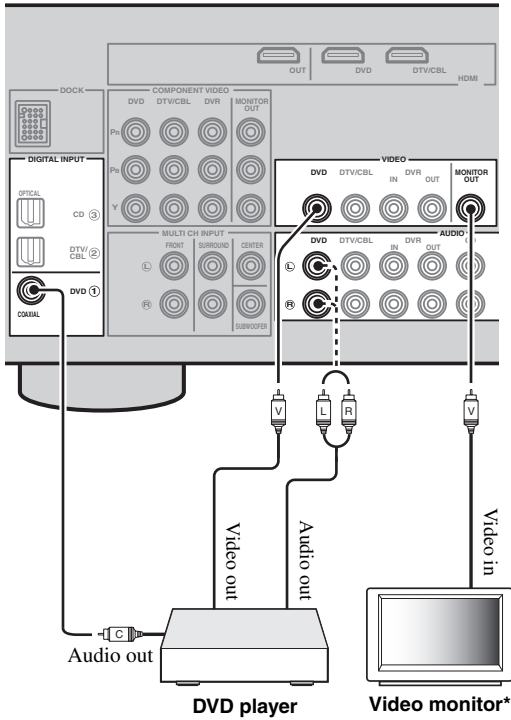

■ Connecting a cable TV/satellite tuner and a DVD recorder

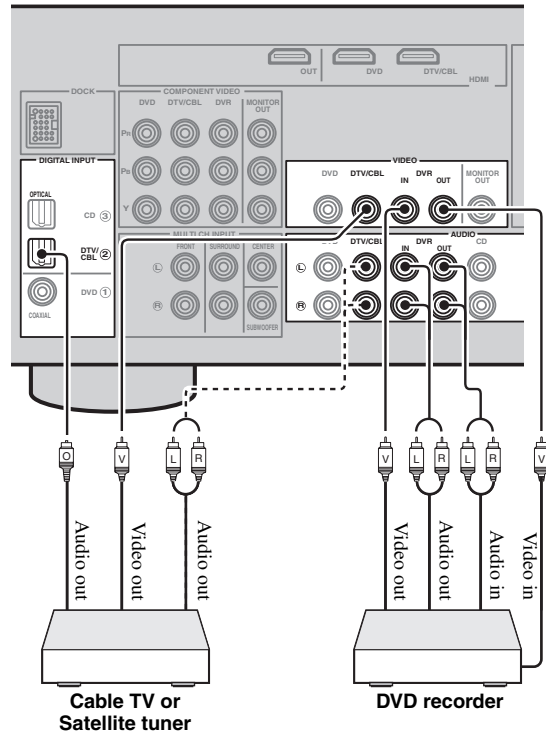

———— indicates recommended connections
 - - - - - indicates alternative connections

———— indicates recommended connections
 - - - - - indicates alternative connections

* When you use the internal tuner of the TV as the input source, connect the digital or analog audio output jacks of the TV and digital or analog audio input jacks of this unit.

■ Connecting to the HDMI or COMPONENT VIDEO jacks

You can enjoy high-quality pictures by connecting your video monitor and video source components to this unit using HDMI or COMPONENT VIDEO connections.

Note

Be sure to connect your video components in the same way you connect your video monitor to this unit. For example, if you connect your video monitor to this unit using an HDMI or COMPONENT VIDEO connection, connect your video components to this unit using the HDMI or COMPONENT VIDEO connection.

HDMI connection

Audio signals input at the HDMI jack are not output from any speaker terminals but output from the connected video monitor.

To enjoy the sound from speakers connected to this unit,

- make an analog or digital connection besides the HDMI connection (see page 15).
- mute the volume of the connected video monitor.

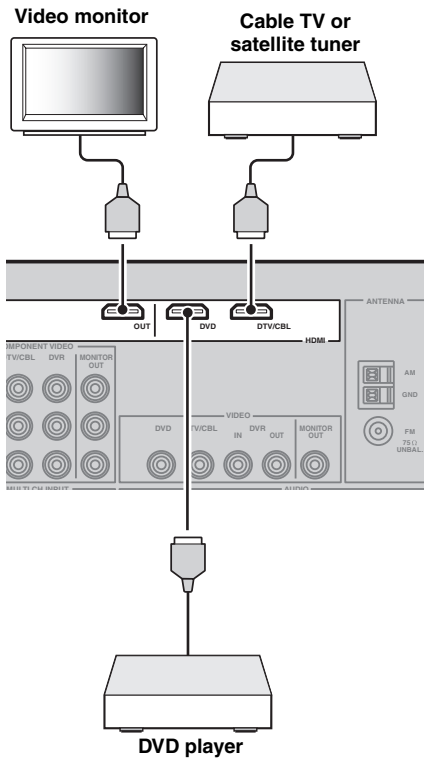

Connecting to the COMPONENT VIDEO jacks

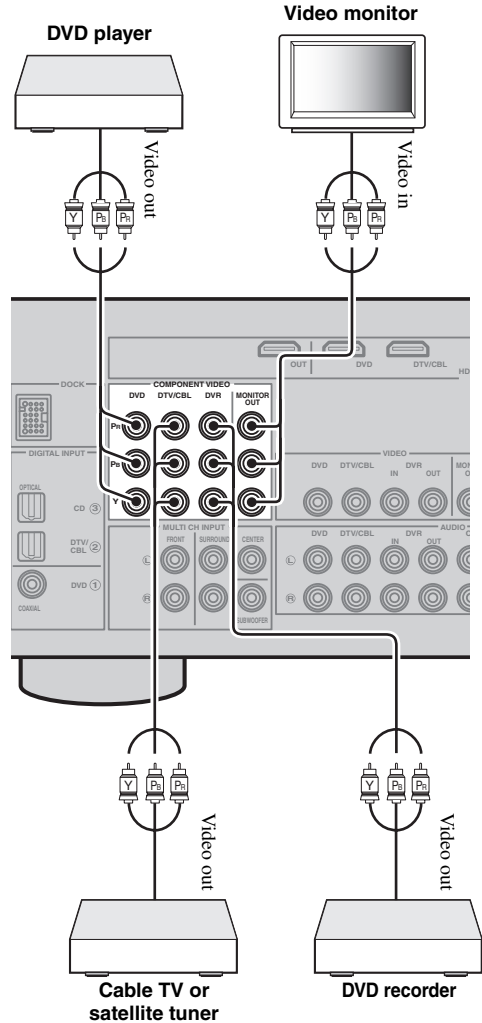

Notes

- Connect the input source components to the HDMI DVD or HDMI DTV/CBL jack to display the video images on the video monitor connected to the HDMI OUT jack.
- Audio/video signals output from the connected component (such as DVD player etc.) are output to the connected video monitor only when this unit is turned on and set to the input source (DVD or DTV/CBL).
- Available audio/video signals depend on the specification of the connected video monitor. Refer to the instruction manual of each connected component.

Connecting audio components

■ Connecting a CD player and a CD recorder/MD recorder

Note

When you connect your CD player via analog and digital connection, priority is given to the signal input at the DIGITAL INPUT jack.



Make sure that this unit and other components are unplugged from the AC wall outlets.

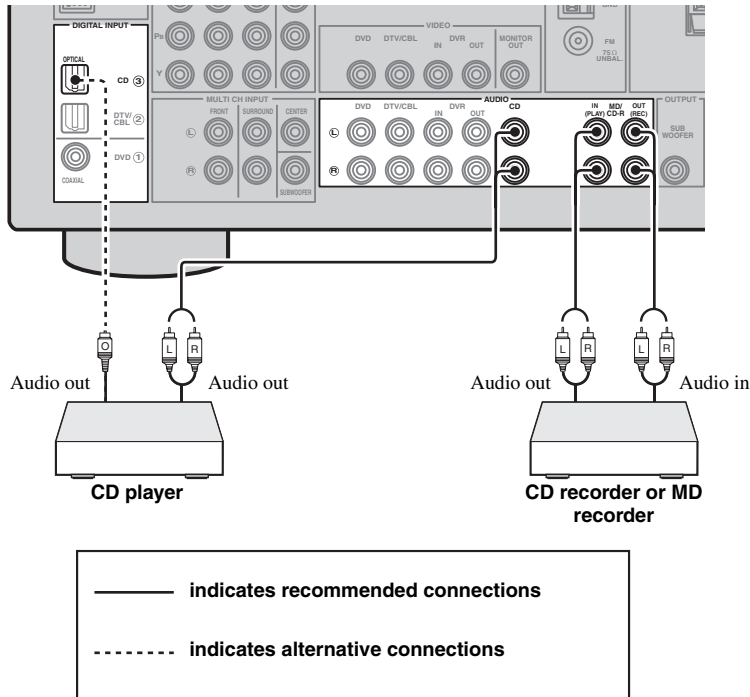

■ Connecting to the MULTI CH INPUT jacks

This unit is equipped with 6 additional input jacks (FRONT L/R, SURROUND L/R, CENTER and SUBWOOFER) for discrete multi-channel input from a multi-format player, external decoder or sound processor. Connect the output jacks on your multi-format player or external decoder to the MULTI CH INPUT jacks. Be sure to match the left and right output jacks to the left and right input jacks for the front and surround channels.

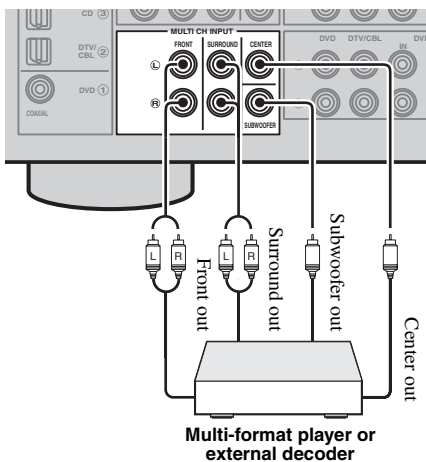

Notes

- When you select the component connected to the MULTI CH INPUT jacks as the input source (see page 30), this unit automatically turns off the digital sound field processor, and you cannot select sound field programs.
- This unit does not redirect signals input at the MULTI CH INPUT jacks to accommodate for missing speakers. We recommend that you connect a 5.1-channel speaker system before using this feature.

Connecting a Yamaha iPod™ universal dock and Bluetooth™ adapter



Make sure that this unit and other components are unplugged from the AC wall outlets.

This unit is equipped with the DOCK terminal on the rear panel that allows you to connect a Yamaha iPod universal dock (such as YDS-10, sold separately) or Bluetooth adapter (such as YBA-10, sold separately). Connect a Yamaha iPod universal dock or Bluetooth adapter to the DOCK terminal on the rear panel of this unit using its dedicated cable.



Refer to “Using iPod™” on page 40 for playback of your iPod and “Using Bluetooth™ components” on page 41 for playback of your Bluetooth components.

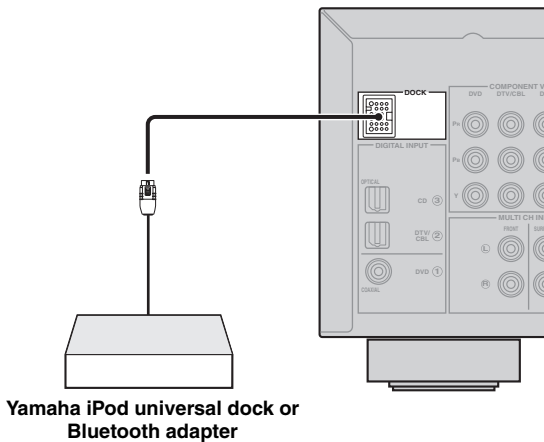

Connecting to the VIDEO AUX jacks on the front panel

Use the VIDEO AUX jacks on the front panel to connect a game console or a video camera to this unit.

Caution

Be sure to turn down the volume of this unit and other components before making connections.

Notes

- The audio signals input at the DOCK terminal on the rear panel take priority over the ones input at the VIDEO AUX jacks.
- To reproduce the source signals input at these jacks, select “V-AUX” as the input source.
- The audio signals input at the PORTABLE mini jack take priority over the ones input at the AUDIO L/R jacks.

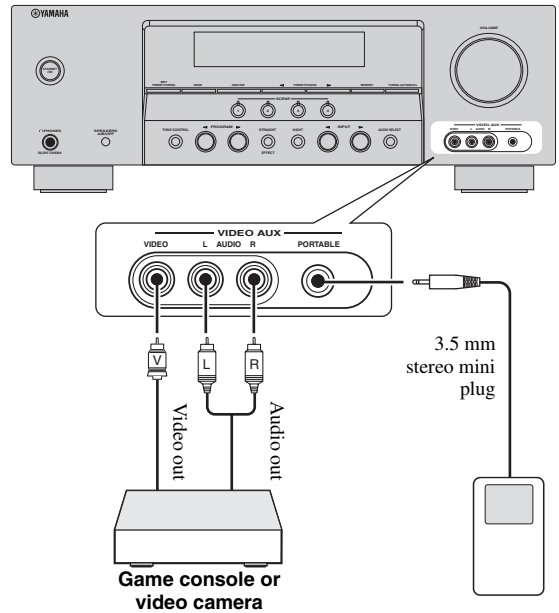

Connecting the FM and AM antennas

Both FM and AM indoor antennas are supplied with this unit. In general, these antennas should provide sufficient signal strength. Connect each antenna correctly to the designated terminals.

Notes

- The AM loop antenna should be placed away from this unit.
- A properly installed outdoor antenna provides clearer reception than an indoor one. If you experience poor reception quality, install an outdoor antenna. Consult the nearest authorized Yamaha dealer or service center about outdoor antennas.
- The AM loop antenna should always be connected, even if an outdoor AM antenna is connected to this unit.

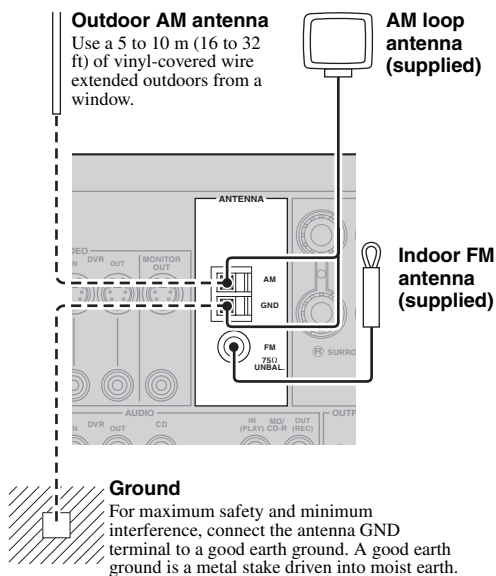

Connecting the wire of the AM loop antenna

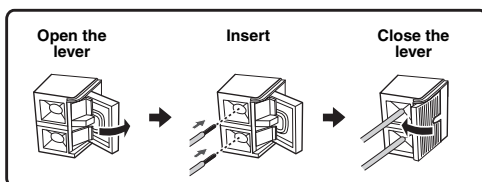

The wire of the AM loop antenna does not have any polarity and you can connect either end of the wire to AM or GND terminal.

Assembling the supplied AM loop antenna

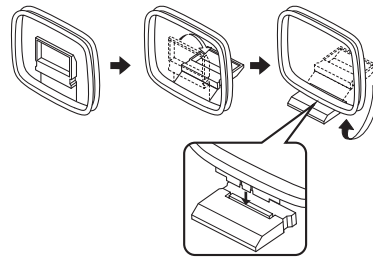

Note

The types of the supplied AM loop antenna is different depending on the models.

Connecting the power cable

Once all connections are complete, plug the power cable into the AC wall outlet.

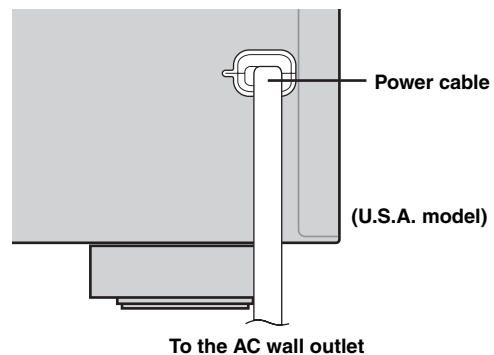

Turning on and off the power

■ Turning on this unit

Press **(A) STANDBY/ON** (or **(14) POWER**) to turn on this unit.



When you turn on this unit, there will be a 4 to 5-second delay before this unit can reproduce sound.

■ Set this unit to the standby mode

Press **(A) STANDBY/ON** (or **(15) STANDBY**) to set this unit to the standby mode.

Note

In the standby mode, this unit consumes a small amount of power in order to receive infrared signals from the remote control.

Front panel display

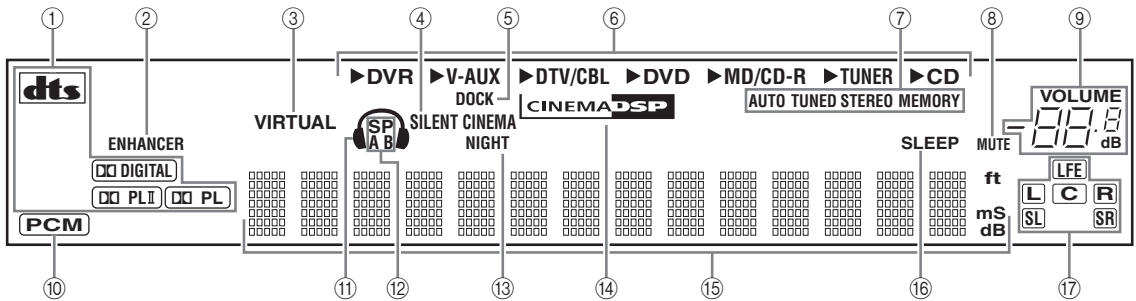

① Decoder indicator

Lights up when any of the decoders of this unit functions.

② ENHANCER indicator

Lights up when the Compressed Music Enhancer mode is selected (see page 34).

③ VIRTUAL indicator

Lights up when Virtual CINEMA DSP is active (see page 36).

④ SILENT CINEMA indicator

Lights up when headphones are connected and a sound field program is selected (see page 36).

⑤ DOCK indicator

- Lights up when you station your iPod in a Yamaha iPod universal dock (such as YDS-10, sold separately) connected to the DOCK terminal of this unit (see page 18) when V-AUX is selected as the input source.
- Flashes while the connected Yamaha Bluetooth adaptor (such as YBA-10, sold separately) and the Bluetooth component is in the pairing (see page 18) or the Bluetooth adaptor is searching the Bluetooth component (see page 41).
- Light up while the connected Yamaha Bluetooth adaptor is connected to the Bluetooth component (see page 18).

⑥ Input source indicators

The corresponding cursor lights up to show the currently selected input source.

⑦ Tuner indicators

Lights up when this unit is in the FM or AM tuning mode (see page 37).

⑧ MUTE indicator

Flashes while the MUTE function is on (see page 30).

⑨ VOLUME level indicator

Indicates the current volume level.

⑩ PCM indicator

Lights up when this unit is reproducing PCM (Pulse Code Modulation) digital audio signals.

⑪ Headphones indicator

Lights up when headphones are connected (see page 30).

⑫ SP A B indicators

Light up according to the set of front speakers selected (see page 29).

⑬ NIGHT indicator

Lights up when you select a night listening mode (see page 31).

⑭ CINEMA DSP indicator

Lights up when you select a sound field program (see page 34).

⑮ Multi-information display

Shows the name of the current sound field program and other information when adjusting or changing settings.

⑯ SLEEP indicator

Lights up while the sleep timer is on (see page 33).

⑰ Input channel and speaker indicators

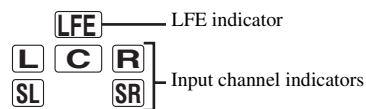

LFE indicator

Lights up when the input signal contains the LFE signal.

Input channel indicators

Indicate the channel components of the current digital input signal.

■ Using the remote control

The remote control transmits a directional infrared ray. Be sure to aim the remote control directly at the remote control sensor on this unit during operation.

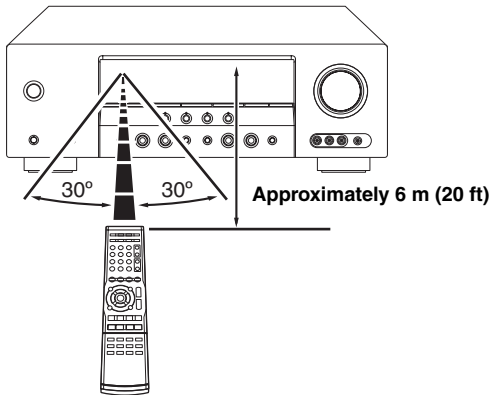

① Infrared window

Outputs infrared control signals. Aim this window at the component you want to operate.



To set the remote control codes for other components, see page 53.

Notes

- Do not spill water or other liquids on the remote control.
- Do not drop the remote control.
- Do not leave or store the remote control in the following types of conditions:
 - places of high humidity, such as near a bath
 - places of high temperature, such as near a heater or stove
 - places of extremely low temperatures
 - dusty places
- To set the remote control codes for other components, see page 53.

Basic setup

The “BASIC SETUP” feature is a useful way to set up your system quickly and with minimal effort.

Notes

- Make sure you disconnect your headphones from this unit.
- If you wish to configure this unit manually using more precise adjustments, use the detailed parameters in “SOUND MENU” (see page 45).
- Altering any parameters in “BASIC SETUP” resets all parameters manually adjusted in “SOUND MENU” (see page 45).
- Initial settings are indicated in bold under each parameter.
- Press **Ⓢ**RETURN on the remote control to return to the previous menu level.

1 Press **Ⓜ**AMP on the remote control.

2 Press **Ⓢ**MENU.

“BASIC SETUP” appears in the front panel display.

• BASIC SETUP

3 Press **Ⓡ**ENTER to enter “BASIC SETUP”.

“ROOM” appears in the front panel display.

ROOM: S M L

4 Press **Ⓡ**◀/▶ to select the desired setting.

Select the size of the room where you have installed your speakers. In general, the room sizes are defined as follows:

Choices: S, **M**, L

[U.S.A. and Canada models]

S (small) 16 x 13 ft, 200 ft² (4.8 x 4.0 m, 20 m²)

M (medium) 20 x 16 ft, 300 ft² (6.3 x 5.0 m, 30 m²)

L (large) 26 x 19 ft, 450 ft² (7.9 x 5.8 m, 45 m²)

[Other models]

S (small) 3.6 x 2.8 m, 10 m²

M (medium) 4.8 x 4.0 m, 20 m²

L (large) 6.3 x 5.0 m, 30 m²

5 Press **Ⓡ**∇ to select “SUBWOOFER” and then **Ⓡ**◀/▶ to select the desired setting.















SUBWOOFER • YES

Choices: **YES**, NONE

- Select “YES” if you have a subwoofer in your system.
- Select “NONE” if you do not have a subwoofer in your system.

6 Press **Ⓡ**∇ to select “SPEAKERS” and then **Ⓡ**◀/▶ to select the number of speakers connected to this unit.

SPEAKERS • 5spk

Choice	Display	Speakers
2spk	 	Front L/R
3spk	  	Front L/R, Center
4spk	   	Front L/R, Surround L/R
5spk	    	Front L/R, Center, Surround L/R

- 7** Press **⏺** to select “SET” and then **⏪/⏩** to select the desired setting.

SET >CANCEL

Choices: SET, CANCEL

- Select “SET” to apply the settings you made.
- Select “CANCEL” to cancel the setup procedure without making any changes.



You can also press **MENU** to cancel the setup procedure.

- 8** Press **ENTER** to confirm your selection.

If you selected “SET” in step 7, each speaker outputs a test tone twice in turn. “CHECK:TestTone” appears in the front panel display for a few seconds and then “CHECK OK?” appears in the front panel display.

CHECK:TestTone



- Check the speaker connections (see page 5) and adjust the “SPEAKERS” settings back in step 6, if necessary.
- The indicator of the speaker currently outputting the test tone flashes in the front panel display.

- 9** Press **⏪/⏩** to select the desired setting.

CHECK OK? . . YES

Choices: YES, NO

- Select “YES” to complete the setup procedure if the test tone levels from each speaker were satisfactory.
- Select “NO” to proceed to the speaker level adjustment menu to balance the output level of each speaker.

- 10** Press **ENTER** to confirm your selection.

- If you selected “YES” in step 9, the setup procedure is completed and the display returns to the top set menu display. Press **MENU** to exit from “BASIC SETUP”.
- If you selected “NO” in step 9, the front speaker level adjustment display appears in the front panel display.

- 11** Press **⏴/⏵** to select a speaker and then **⏪/⏩** to adjust the balance.

The selected speaker and the front left speaker (or the surround left speaker) output a test tone in turn.

- Press **⏩** to increase the value.
- Press **⏪** to decrease the value.

FR ----- ||-----

- Select “FR” to adjust the balance between the front left and right speakers.
- Select “C” to adjust the balance between the front left and center speakers.
- Select “SL” to adjust the balance between the front left and surround left speakers.
- Select “SR” to adjust the balance between the surround left and surround right speakers.
- Select “SWFR” to adjust the balance between the front left speaker and the subwoofer.

Note

The available speaker channels differ depending on the setting of the speakers.

- 12** Press **MENU** to exit from “BASIC SETUP”.

Selecting the SCENE templates

This unit is equipped with 13 preset SCENE templates for various situations of using this unit. As the initial factory setting, the following SCENE templates are assigned to each SCENE button:

- SCENE 1:** DVD Viewing
- SCENE 2:** Disc Listening
- SCENE 3:** TV Viewing
- SCENE 4:** Radio Listening

If you want to use other SCENE templates, you can select the desired SCENE templates from the SCENE template library and assign the templates to the selected SCENE buttons on the front panel and the remote control.

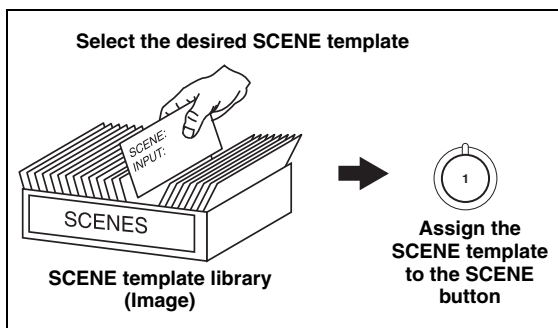

Selecting the desired SCENE template

- 1 Press and hold the desired \textcircled{P} SCENE (or $\textcircled{5}$ SCENE) button for 3 seconds.**

The indicator on the selected SCENE button on the front panel starts to flash, and the name of currently assigned SCENE template appears in the front panel display.

3 seconds



or

3 seconds

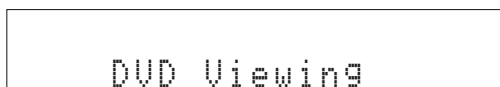

- 2 Press \textcircled{N} INPUT $\triangleleft/\triangleright$ (or press $\textcircled{4}$ AMP and then $\textcircled{7}$ $\triangleleft/\triangleright$) to select the desired template.**

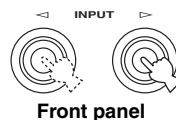

or

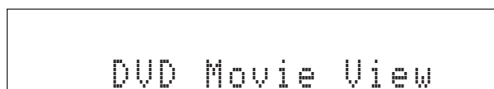
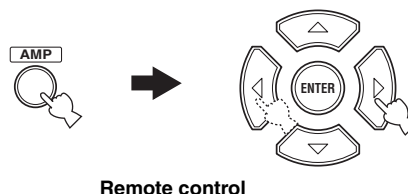

- 3 Press the \textcircled{P} SCENE (or $\textcircled{5}$ SCENE) button again to confirm the selection.**

The selected SCENE template is assigned to the button.



or



To cancel the procedure, press $\textcircled{4}$ AMP and then $\textcircled{8}$ RETURN.

Note

Once the desired SCENE templates are assigned to the corresponding SCENE buttons, you may need to set the input source of the SCENE template on the remote control. See page 28 for details.

■ Which SCENE template would you like to select?

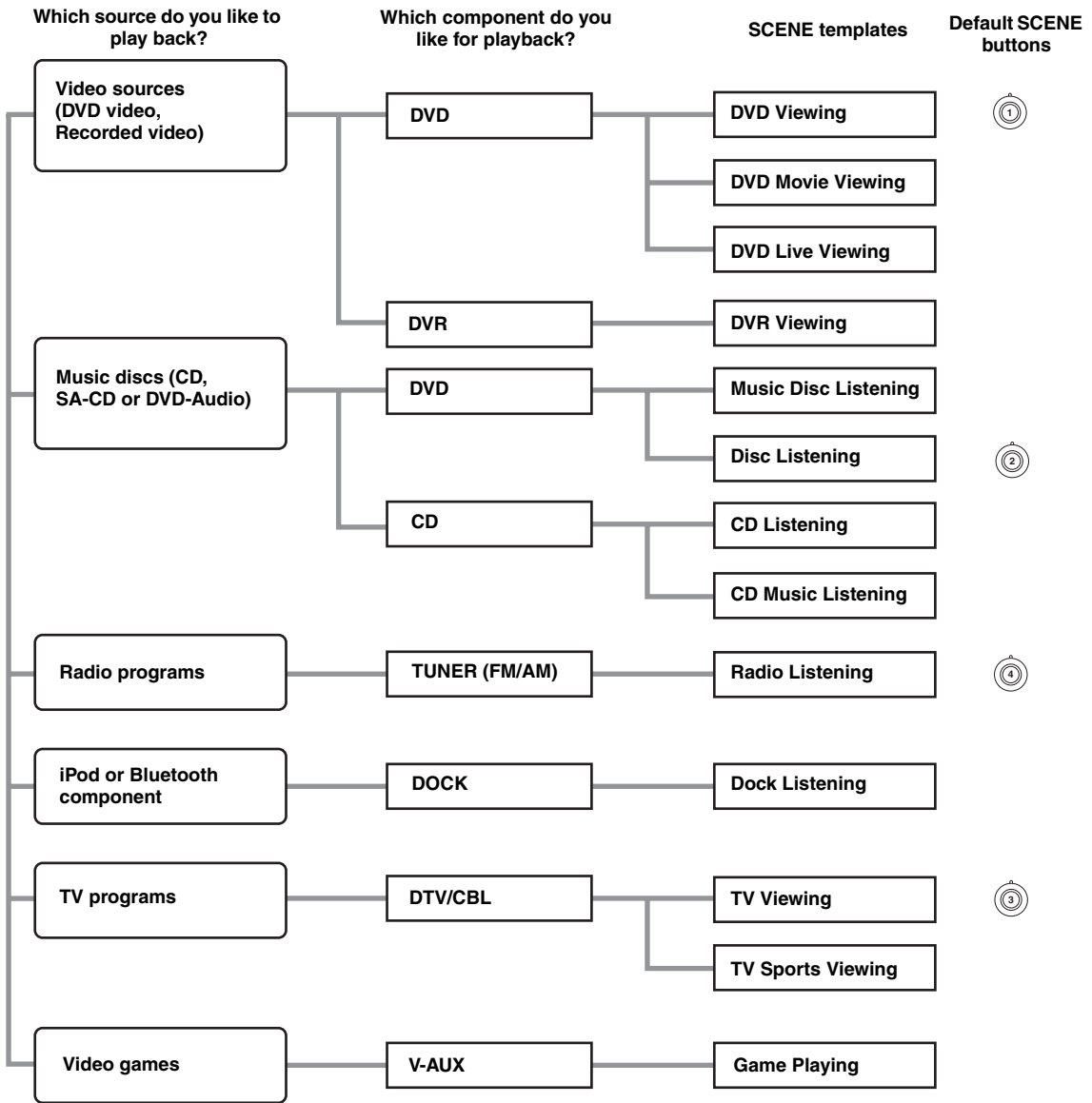

Note

When iPod is connected to the Yamaha iPod universal dock or a Bluetooth component is connected to the Bluetooth adapter, this unit plays back the audio sources input at the DOCK terminal.



You can create your original SCENE templates by editing the preset SCENE templates. See page 27 for details.

■ Preset SCENE template descriptions

SCENE template	
Features	
Input source	Playback mode

DVD Viewing (SCENE 1 as the default setting)	
Select this SCENE template when you play back general contents on your DVD player.	
DVD	STRAIGHT

DVD Movie Viewing	
Select this SCENE template when you play back movies on your DVD player.	
DVD	Movie Dramatic

DVD Live Viewing	
Select this SCENE template when you enjoy music live video on your DVD player.	
DVD	Pop/Rock

DVR Viewing	
Select this SCENE template when you play back movies on your digital video recorder.	
DVR	Movie Dramatic

Music Disc Listening	
Select this SCENE template when you play back music discs on your DVD player.	
DVD	2ch Stereo

Disc Listening (SCENE 2 as the default setting)	
Select this SCENE template when you play back music sources as the back ground music on your DVD player.	
DVD	5ch Stereo

CD Listening	
Select this SCENE template when you play back music source as the back ground music on your CD player.	
CD	5ch Stereo

CD Music Listening	
Select this SCENE template when you play back music discs on your CD player.	
CD	2ch Stereo

Radio Listening (SCENE 4 as the default setting)	
Select this SCENE template when you enjoy FM or AM radio programs.	
TUNER	Music Enh. 5ch

Dock Listening	
Select this SCENE template when you play back music on your iPod stationed in a Yamaha iPod universal dock or Bluetooth component that is connected to the Bluetooth adapter.	
DOCK	Music Enh. 5ch

TV Viewing (SCENE 3 as the default setting)	
Select this SCENE template when you enjoy TV programs.	
DTV/CBL	STRAIGHT

TV Sports Viewing	
Select this SCENE template when you enjoy sports programs on TV.	
DTV/CBL	TV Sports

Game Playing	
Select this SCENE template when you play video games.	
V-AUX	Game

Creating your original SCENE templates

You can create your original SCENE templates for each SCENE button. You can refer to the preset 13 SCENE templates to create the original SCENE templates.

■ Customizing the preset SCENE templates

Use this feature to customize the preset SCENE templates.

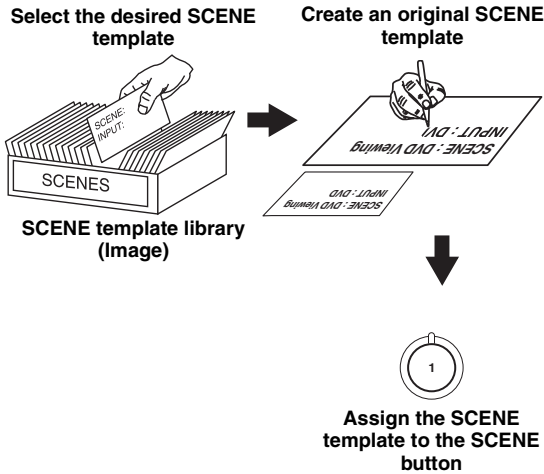

1 Press and hold the desired **⑤ SCENE** button for 3 seconds and then press **④ AMP**.

The SCENE template customizing display appears on the front panel display.



Note

When the SCENE template you want to customize is not assigned to any of the **⑤ SCENE** button, press **⑦ </>** repeatedly to recall the desired SCENE template (see page 24).

2 Press **⑦ Δ / ▽** to select the desired parameter of the SCENE template and then **⑦ </>** to select the desired value of the selected parameter.

You can adjust the following parameters for a SCENE template:

- The input source component
- The active sound field programs or STRAIGHT mode
- The night listening mode setting (see page 31)
 - SYSTEM: Keeps the current night listening mode.
 - CINEMA: Sets the night listening mode to the CINEMA mode.
 - MUSIC: Sets the night listening mode to the MUSIC mode.

3 Press the **⑤ SCENE** button again to confirm the edit.



- An asterisk mark (*) appears by the name of the original SCENE template.
- To cancel the procedure, press **④ AMP** and then **⑥ RETURN**.

Notes

- After changing the assignment of the SCENE template to the **⑤ SCENE** buttons, you may need to set the input source of the SCENE template on the remote control. See page 28 for details.
- You can create a customized SCENE template for each **⑤ SCENE** button, and if you create another customized SCENE template, this unit overwrites the old customized SCENE template with the new one.
- The customized SCENE template is only available for the assigned **⑤ SCENE** button.

Using remote control on the SCENE feature

■ Controlling the input source components in the SCENE mode

You can operate both this unit and the input source component by using the remote control. You must set the appropriate remote control code for each input source in advance (see page 53).

1 Press the desired **⑤ SCENE** button on the remote control.

2 Press the desired buttons in the * area below to control the input source component of the selected SCENE template.

■ Setting input source of the customized SCENE template on the remote control

If you customize the input source of the selected SCENE template, you must set the input source of the SCENE template on the remote control to operate the input source component correctly.

Press and hold the **⑤ SCENE** button and the desired input selector button (**③**) for 3 seconds.



Press the **⑤ SCENE** button again to operate the input source component.

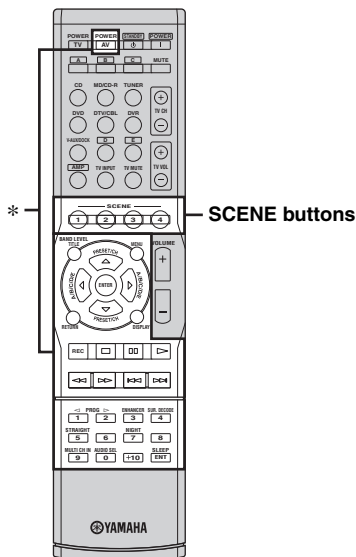

Note

* These buttons control the input source component. See page 51 for details of the function of each button.

Playback

Caution

Extreme caution should be exercised when you play back CDs encoded in DTS. If you play back a CD encoded in DTS on a DTS-incompatible CD player, you will only hear some unwanted noise that may damage your speakers. Check whether your CD player supports CDs encoded in DTS. Also, check the sound output level of your CD player before you play back a CD encoded in DTS.

Basic operations

1 Turn on the video monitor connected to this unit.

2 Press **SPEAKERS repeatedly to select the front speakers you want to use.**

The respective speaker indicators lights up in the front panel display.

3 Press **INPUT $\triangleleft/\triangleright$ repeatedly (or press one of the input selector buttons (3)) to select the desired input source.**

The name of the currently selected input source appears in the front panel display for a few seconds.

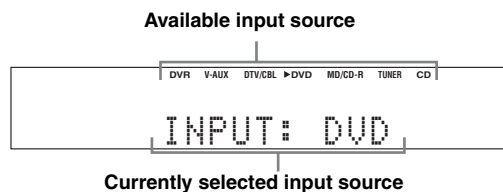

4 Start playback on the selected component or select a broadcast station.

- Refer to the operating instructions for the source component.
- See page 37 for details about FM or AM tuning instructions.

5 Rotate **VOLUME (or press **VOLUME** +/-) to adjust the volume to the desired output level.**

6 Press **PROGRAM $\triangleleft/\triangleright$ (or press **AMP** and then press **PROG** $\triangleleft/\triangleright$) repeatedly to select the desired sound field program.**

The name of the selected sound field program appears in the front panel display.

See page 34 for details about sound field programs.



Currently selected surround field program

Notes

- Choose a sound field program based on your listening preference, not merely on the name of the program.
- When you select an input source, this unit automatically selects the last sound field program used with the corresponding input source.
- Sound field programs cannot be selected when the component connected to the MULTI CH INPUT jacks is selected as the input source (see page 30).
- When PCM signals with a sampling frequency higher than 48 kHz are input, this unit is automatically set to the "STRAIGHT" mode (see page 36).
- To display information about the currently selected input source in the front panel display, see page 32 for details.

■ Guide to contents

When you want to...	See page
Adjust the tonal quality of the front speakers	31
Edit parameters of sound field programs	35
Enjoy the sources which have wide dynamic range at night	31
Use headphones	30
Select a decoder to play back sources with	35
Set this unit to the standby mode automatically	33

Additional operations

■ Using your headphones

Connect a pair of headphones with a stereo analog audio cable plug to the PHONES jack on the front panel.

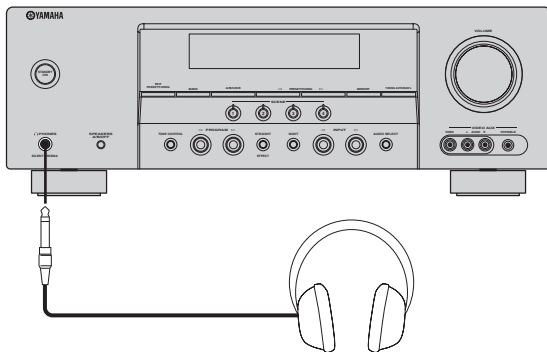

When you select a sound field program, SILENT CINEMA mode is automatically activated (see page 36).

Notes

- When you connect headphones, no signals are output at the speaker terminals.
- All Dolby Digital and DTS audio signals are mixed down to the left and right headphone channels.

■ Muting the audio output

Press **MUTE** to mute the audio output.

Press **MUTE** again to resume the audio output.



- You can also rotate **VOLUME** (or press **VOLUME +/-**) to resume the audio output.
- You can adjust the muting level by using “MUTE TYP.” in “SOUND MENU” (see page 48).
- The MUTE indicator flashes in the front panel display when the audio output is muted and disappears from the front panel display when the audio output is resumed.

■ Selecting the front speaker set

Press **SPEAKERS** repeatedly to turn on or off the set of front speakers connected to the FRONT A or FRONT B speaker terminals.

The active front speaker set changes as follows:

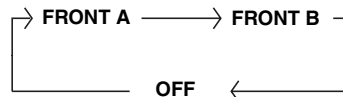

Note

Turn off the volume level of this unit when you switch the front speaker setting.

■ Using the Zone B feature

When you set “FRONT B” to “ZONE B” (see page 45), you can use the speakers connected to the FRONT B speaker terminals in another room (Zone B).

Press **SPEAKERS** on the front panel

repeatedly to turn on or off the Zone B speakers.

When you activate the Zone B speakers, all the speakers in the main room are muted.

Notes

- You cannot activate both the main room and Zone B speakers simultaneously.
- If you select CINEMA DSP sound field program and activate the Zone B speakers, Virtual CINEMA DSP activates automatically (see page 36).

■ Selecting the component connected to the MULTI CH INPUT jacks as the input source

Use this feature to select the component connected to the MULTI CH INPUT jacks (see page 17) as the input source.

Press **INPUT** **</>** repeatedly (or press **AMP** and then press **MULTI CH IN**) so that “MULTI CH” appears in the front panel display.



Use “MULTI CH SET” menu in “INPUT MENU” to set the parameter for MULTI CH INPUT (see page 49).

Notes

- The input signals are amplified and output directly without sound processing. Therefore, you cannot activate sound field programs, the night listening mode, etc. while MULTI CH is selected as the input source.
- When headphones are used, signals are output only from the front left and right channels.

■ Selecting audio input jacks (AUDIO SELECT)

This unit comes with a variety of input jacks. Use this feature (audio input jack select) to switch the input jack assigned to an input source when more than one jacks are assigned to an input source.



- We recommend setting audio input jack select to “AUTO” in most cases.
- You can adjust the default audio input jack select of this unit by using “AUDIO SELECT” in “OPTION MENU” (see page 50).

Press **Ⓞ** **AUDIO SELECT** (or press **④** **AMP** and then **Ⓡ** **AUDIO SEL**) repeatedly to select the desired Audio input jack select setting.



Audio input jack select setting

AUTO	Automatically selects input signals in the following order: (1) Digital signals (2) Analog signals
ANALOG	Selects only analog signals. If no analog signals are input, no sound is output.

Note

This feature is not available when no digital input jack are assigned to the currently selected input source.

■ Selecting the night listening mode

The night listening modes are designed to improve listenability at lower volumes or at night.

1 Press **④** **AMP** and then press **Ⓡ** **NIGHT** repeatedly to select “NIGHT:CINEMA” or “NIGHT:MUSIC”.

Choices: NIGHT:CINEMA, NIGHT:MUSIC, NIGHT OFF

- Select “NIGHT:CINEMA” to reduce the dynamic range of film soundtracks and make dialog easier to hear at lower volumes.
- Select “NIGHT:MUSIC” to preserve ease-of-listening for all sounds.
- Select “NIGHT OFF” if you do not want to use this feature.



When a night listening mode is selected, the NIGHT indicator lights up in the front panel display.

2 Press **⑦** **</>** to adjust the effect level while “NIGHT:CINEMA” or “NIGHT:MUSIC” is displayed in the front panel display.

Choices: MIN, MID, MAX

- Select “MIN” for minimum compression.
- Select “MID” for standard compression.
- Select “MAX” for maximum compression.



“NIGHT:CINEMA” and “NIGHT:MUSIC” adjustments are stored independently.

Notes

- You cannot use the night listening modes in the following cases:
 - when the component connected to the MULTI CH INPUT jacks is selected as the input source.
 - when headphones are connected to the PHONES jack.
 - when the sampling frequency of the input sources are higher than 96 kHz.
- The night listening modes may vary in effectiveness depending on the input source and surround sound settings you use.

■ Adjusting the tonal quality

Use this feature to adjust the balance of bass and treble for the front left and right speaker channels.

Press **Ⓢ** **TONE CONTROL** repeatedly to select “BASS” or “TREBLE” and then press **Ⓡ** **PROGRAM** **</>** to adjust the corresponding frequency response level.

Control range: -10 to +10 dB

Control step: 2

- Select “BASS” to adjust the low-frequency response.
- Select “TREBLE” to adjust the high-frequency response.

Notes

- Speaker and headphone adjustments are stored independently.
- If you increase or decrease the high-frequency or low-frequency sound to an extreme level, the tonal quality of the surround speakers may not match that of the front left and right speakers.

■ Adjusting speaker levels during playback

You can adjust the output level of each speaker while listening to a music source.

Note

This operation will override the level adjustment made in “SP LEVEL” (see page 46).

- 1 Press **④AMP** and then press **⑥LEVEL** repeatedly to select the speaker you want to adjust.

Display	Adjusted speaker
FRONT L	Front left speaker
FRONT R	Front right speaker
CENTER	Center speaker
SWFR	Subwoofer
SUR. L	Surround left speaker
SUR. R	Surround right speaker



Once you press **⑥LEVEL** on the remote control, you can also select the speaker by pressing **⑦△ / ▽**.

- 2 Press **⑦< / >** on the remote control to adjust the speaker output level.

The control range is from -10 dB to +10 dB.



You can press **①A/B/C/D/E** to select a speaker and then **①PRESET/TUNING < / >** to adjust the speaker output level.

■ Displaying the signal information

You can display the format, sampling frequency, channel, bit rate and flag data of the current input signal.

- 1 Press **④AMP** and then press **①MENU** on the remote control.
“BASIC SETUP” appears in the front panel display.

• BASIC SETUP

- 2 Press **⑦△ / ▽** repeatedly to select “SIGNAL INFO” and then press **⑦ENTER**.

- 3 Press **⑦△ / ▽** to switch the displayed information.

The following information about the input source appears in the front panel display.

Display	Description
Format	Signal format.
Sampling frequency	The number of samples per second taken from a continuous signal to make a discrete signal.
Channel	The number of source channels in the input signal (front/surround/LFE).
Bit rate	The number of bits passing a given point per second.
Flag data	Flag data encoded in DTS, Dolby Digital, or PCM signals that cue this unit to automatically switch decoders.

- 4 Press **①MENU** to exit.

■ Using the sleep timer

Use this feature to automatically set this unit to the standby mode after a certain amount of time.

Press **4 AMP** and then press **25 SLEEP** repeatedly to set the amount of time.

Each time you press **25 SLEEP**, the front panel display changes as shown below.

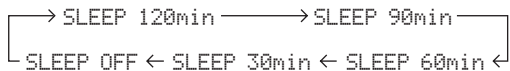

The SLEEP indicator flashes while you are switching the amount of time for the sleep timer. Once the sleep timer is set, the SLEEP indicator lights up in the front panel display, and the display returns to the selected sound field program.



- To cancel the sleep timer, press **25 SLEEP** on the remote control repeatedly until "SLEEP OFF" appears in the front panel display.
- You can also cancel the sleep timer setting by pressing **A STANDBY/ON** (or **15 STANDBY**) to set this unit to the standby mode.

■ Playing video sources in the background

You can combine a video image from a video source with sound from an audio source. For example, you can enjoy listening to classical music while viewing beautiful scenery from the video source on the video monitor.

Press the input selector buttons **(3)** on the remote control to select a video source and then an audio source.

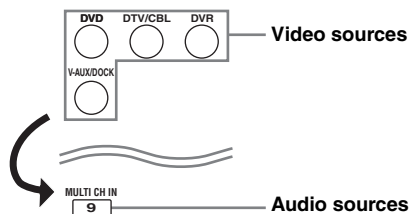
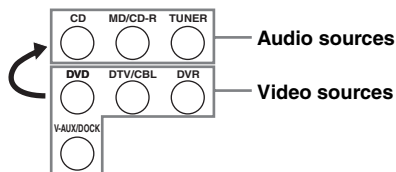

Sound field programs

This unit is equipped with a variety of precise digital decoders that allow you to enjoy multi-channel playback from almost any stereo or multi-channel sound source.

Press **ⓀPROGRAM** $\triangleleft/\triangleright$ (or press **④AMP** and then press **ⓀPROG** $\triangleleft/\triangleright$ repeatedly).

The name of the selected sound field program appears in the front panel display.

Notes

- When you select an input source, this unit automatically selects the last sound field program used with the corresponding input source.

- Sound field programs cannot be selected when the component connected to the MULTI CH INPUT jacks is selected as the input source (see page 30).
- When PCM signals with a sampling frequency higher than 48 kHz are input, this unit is automatically set to the “STRAIGHT” mode (see page 36).
- When the sampling frequency of the input sources are higher than 96 kHz, this unit does not apply any sound field programs.



- Choose a sound field program based on your listening preference, not merely on the name of the program itself.
- You can select “Music Enh. 2ch” and “Music Enh. 5ch” by pressing **ⓀENHANCER** repeatedly.

Sound field program descriptions

Category	Program	Features
MUSIC	Pop/Rock	CINEMA DSP processing. This program presents an image of pop, rock, or jazz live concert. The sound field reproduces the spaciousness of a massive pavilion with an emphasis on the vividness of vocals on the stage and solo instruments and the beats of rhythm instruments.
	Hall	CINEMA DSP processing. This sound field is suitable for classic and orchestral music. The program uses data collected in a large concert hall in Munich. You can enjoy delicate and beautiful reverberation and a majestic atmosphere.
	Jazz	CINEMA DSP processing. The sound field is suitable for jazz and fusion music. It uses data collected in a famous jazz club in New York. You can enjoy clear reverberation.
ENTERTAIN	Game	CINEMA DSP processing. You can enjoy dynamic and thrilling sound effects as you play games. The program lets you feel the depth and three-dimensional surrounding sounds of the field where you are playing, and offers cinema-like surrounding sound effects for the scenes of movies.
	TV Sports	CINEMA DSP processing. You can enjoy sports relays broadcast in stereo and variety shows with a live sound environment. For sports relays, the voices of commentators and announcers come clearly from the center; the cheers and atmosphere in the stadium spread around within a comfortable range, and you can feel like as if you are in the stadium.
MOVIE	Movie Spacious	CINEMA DSP processing. The sound field is suitable for movies with an emphasis on spectacular sound effects, and is a perfect fit with a wide screen. The program reproduces a wide dynamic range from minimum sound effects to powerful sounds.
	Movie Dramatic	CINEMA DSP processing. This sound field is also suitable for movies with an emphasis on three-dimensional sound effects. It restrains reverberation to an moderate extent, but reproduces sound effects and background music in a soft, three-dimensional manner with clarity and center orientation of voices as pivots.
STEREO	2ch Stereo	Downmixes multi-channel sources to 2 channel or plays back 2-channel sources as they are.
	5ch Stereo	CINEMA DSP processing. Using this program increases the listening position range. This is a sound field suitable for background music at parties.
ENHANCER	Music Enh. 2ch Music Enh. 5ch	Select these programs to play back compression artifacts (such as the MP3 format) in 2-channel or 5-channel stereo. This program enhances your listening experience by regenerating the missing harmonics in a compression artifact.

Note

The sound field programs of this unit are recreations of real-world acoustic environments made from precise measurements taken in the actual concert hall, music venue, movie theater, etc. Thus, you may notice variations in the strength of the reflections coming from the front, back, left and right.

■ Selecting decoders for 2-channel sources (surround decode mode)

Signals input from 2-channel sources can also be played back on multi-channels.

Press **④AMP** and then press **②SUR. DECODE** repeatedly to select a decoder.

You can select from the following decoders depending on the type of source you are playing and your personal preference.

STANDARD	Functions
PRO LOGIC	Dolby Pro Logic processing for any sources
PLII Movie	Dolby Pro Logic II processing for movie sources
PLII Music	Dolby Pro Logic II processing for music sources
PLII Game	Dolby Pro Logic II processing for game sources

■ Editing sound fields parameters

You can enjoy good quality sound with the factory default parameters. Although you do not have to change the initial settings, you can change some of the parameters to better suit the input source or your listening room.

1 While listening to a source, press **④AMP** and then press **⑦△ / ▽** to select the desired parameter.

2 Press **⑦◀ / ▶** to change the parameter value.

Note

You cannot change parameter values when "MEM.GUARD" in "OPTION MENU" is set to "ON" (see page 50).



Initial settings are indicated in bold under each parameter.

For Pop/Rock, Hall, Jazz, Game, TV Sports, Movie Spacious and Movie Dramatic:

DSP level DSP LEVEL

Function: Adjusts the effect level.

Choices: MIN, **MID**, MAX

For PRO LOGIC II Music:

Panorama PANORAMA

Function: Sends stereo signals to the surround speakers as well as the front speakers for a wraparound effect.

Choices: **OFF**, ON

Dimension DIMENSION

Function: Gradually adjusts the sound field either towards the front or towards the rear.

Control range: -3 (towards the rear) to +3 (towards the front), initial setting is **STD** (standard).

Center width CT WIDTH

Function: Adjusts the center image from all three front speakers to varying degrees. A larger value adjusts the center image towards the front left and right speakers.

Control range: 0 (center channel sound is output only from center speaker) to 7 (center channel sound is output only from front left and right speakers), initial setting is 3.

For Music Enh. 2ch and Music Enh. 5ch

Effect level EFCL LVL

Function: Adjusts the effect level.

Choices: LOW, **HIGH**

■ Using sound field programs without surround speakers (Virtual CINEMA DSP)

Virtual CINEMA DSP allows you to enjoy the CINEMA DSP programs without surround speakers by creating virtual speakers.

If you set “SUR. LR” to “NONE” (see page 47), Virtual CINEMA DSP is automatically activated whenever you select a sound field program (see page 34).

Note

Virtual CINEMA DSP will not be activated even when “SUR. LR” is set to “NONE” (see page 45) in the following cases:

- when “5ch Stereo” (see page 34) is selected.
- when headphones are connected to the PHONES jack.

■ Enjoying multi-channel sources and sound field programs with headphones (SILENT CINEMA)

SILENT CINEMA allows you to enjoy multi-channel music or movie sound, including Dolby Digital and DTS sources, through ordinary headphones. SILENT CINEMA is automatically activated whenever you connect headphones to the PHONES jack while listening to sound field programs (except for 2ch Stereo and Music Enh. 2ch) (see page 34). When SILENT CINEMA is activated, the SILENT CINEMA indicator lights up in the front panel display.

■ Enjoying unprocessed input sources (Straight decoding mode)

When this unit is in the “STRAIGHT” mode, multi-channel sources are decoded straight into the appropriate channels without any additional effect processing. 2-channel stereo sources are output from only the front left and right speakers.

Press **Ⓛ STRAIGHT** (or press **Ⓜ AMP** and then **Ⓛ STRAIGHT**) to select “STRAIGHT”.

To deactivate the “STRAIGHT” mode, press **Ⓛ STRAIGHT** (or **Ⓜ STRAIGHT**) again so that “STRAIGHT” disappears from the front panel display.

FM/AM tuning

There are 2 tuning methods: automatic and manual. Automatic tuning is effective when station signals are strong and there is no interference. If the signal from the station you want to select is weak, tune into it manually. You can also use the automatic and manual preset tuning features to store up to 40 stations.

Automatic tuning

Automatic tuning is effective when station signals are strong and there is no interference.

- 1 Press **ⓃINPUT** $\triangleleft/\triangleright$ repeatedly so that “TUNER” is displayed in the front panel display.
- 2 Press **ⓄBAND** to select the reception band (FM or AM).
- 3 Press **ⓄTUNING AUTO/MAN'L** so that the AUTO indicator lights up in the front panel display.

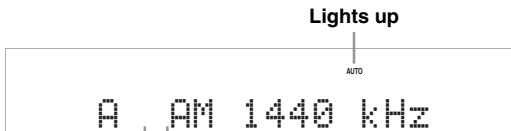

No colon (:)

If a colon (:) appears in the front panel display, automatic tuning is not possible. Press **ⓄPRESET/TUNING** to turn the colon (:) off.

- 4 Press **ⓄPRESET/TUNING** $\triangleleft/\triangleright$ once to begin automatic tuning.
When this unit is tuned into a station, the TUNED indicator lights up and the frequency of the received station is shown in the front panel display.



Manual tuning

If the signal received from the station you want to select is weak, tune into it manually.

Note

Manually tuning into an FM station automatically switches the tuner to monaural reception to increase the signal quality.

- 1 Press **ⓃINPUT** $\triangleleft/\triangleright$ repeatedly so that “TUNER” is displayed in the front panel display.
- 2 Press **ⓄBAND** to select the reception band (FM or AM).
- 3 Press **ⓄTUNING AUTO/MAN'L** so that the AUTO indicator disappears from the front panel display.

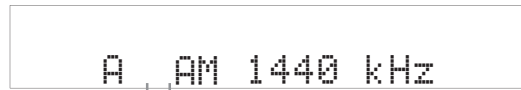

No colon (:)

If a colon (:) appears in the front panel display, manual tuning is not possible. Press **ⓄPRESET/TUNING** to turn the colon (:) off.

- 4 Press **ⓄPRESET/TUNING** $\triangleleft/\triangleright$ to tune into the desired station manually.
You can hold down the button to continue searching.

Automatic preset tuning

You can use the automatic preset tuning feature to store FM stations with strong signals up to 40 (A1 to E8: 8 preset station numbers in each of the 5 preset station groups) of those stations in order. You can then recall any preset station easily by selecting the preset station number.

- 1 Press **ⓃINPUT** $\triangleleft/\triangleright$ repeatedly so that “TUNER” is displayed in the front panel display.
- 2 Press **ⓄBAND** to select “FM” as the reception band.
- 3 Press and hold **ⓂMEMORY** for more than 3 seconds.
The preset station number as well as the MEMORY and AUTO indicators flashes. After approximately 5 seconds, automatic presetting starts from the current frequency and proceeds toward the higher frequencies.

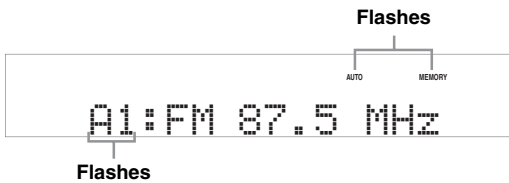

When automatic preset tuning is completed, the front panel display shows the frequency of the last preset station.



You can select the preset station group and the preset station number where the first received station will be stored by pressing **ⓄA/B/C/D/E** and then **ⓂPRESET/TUNING** $\triangleleft/\triangleright$.

Notes

- Any stored station data existing under a preset station number is cleared when you store a new station under the same preset station number.
- Only FM stations with sufficient signal strength are stored automatically by automatic preset tuning. If the station you want to store is weak in signal strength, tune into it manually and store it as described in “Manual preset tuning” on this page.

Manual preset tuning

You can also store up to 40 stations (A1 to E8: 8 preset station numbers in each of the 5 preset station groups) manually.

- 1 Tune into a station automatically or manually.
See page 37 for tuning instructions.
- 2 Press **ⓂMEMORY**.
The MEMORY indicator flashes in the front panel display for approximately 30 seconds.
- 3 Press **ⓄA/B/C/D/E** and **ⓂPRESET/TUNING** $\triangleleft/\triangleright$ repeatedly to select a preset station group and number (A1 to E8) while the MEMORY indicator is flashing.
Check that the colon (:) appears in the front panel display.

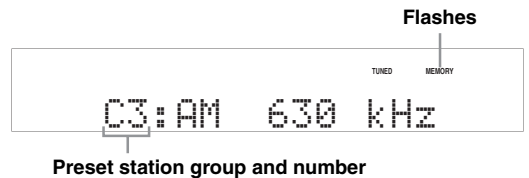

- 4 Press **ⓂMEMORY** while the MEMORY indicator is flashing.
The station band and frequency appear in the front panel display with the preset station group and number you have selected.



The displayed station has been stored as C3.

Notes

- Any stored station data existing under a preset station number is cleared when you store a new station under the same preset station number.
- The reception mode (stereo or monaural) is stored along with the station frequency.

Selecting preset stations

You can tune into any desired station simply by selecting the preset station group and number under which it was stored.



When performing this operation with the remote control, press **TUNER** to select "TUNER" as the input source.

- 1 Press **A/B/C/D/E** (or **A/B/C/D/E** $\triangleleft/\triangleright$) repeatedly to select the desired preset station group (A to E).

The preset station group letter appears in the front panel display and changes each time you press the button.

- 2 Press **PRESET/TUNING** $\triangleleft/\triangleright$ (or **PRESET/CH** \triangle/∇) to select the desired preset station number (1 to 8).

The preset station group and number appear in the front panel display along with the station band and frequency.



You can select the desired preset station number (1 to 8) directly by pressing the numeric buttons (**1-8**).

Exchanging preset stations

You can exchange the assignments of two preset stations with each other. The example below describes the procedure to exchange preset station "E1" with "A5".

- 1 Select preset station "E1" using **A/B/C/D/E** and **PRESET/TUNING** $\triangleleft/\triangleright$.

See "Selecting preset stations" on this page.

- 2 Press and hold **PRESET/TUNING** for more than 3 seconds.

"E1" and the MEMORY indicator flash in the front panel display.



- 3 Select preset station "A5" using **A/B/C/D/E** and **PRESET/TUNING** $\triangleleft/\triangleright$.

"A5" and the MEMORY indicator flash in the front panel display.

See "Selecting preset stations" on this page.



- 4 Press **PRESET/TUNING** again.

"EXCHANGE E1-A5" appears in the front panel display and the assignments of the two preset stations are exchanged.

Using iPod™

Once you have stationed your iPod in a Yamaha iPod universal dock (such as the YDS-10, sold separately) connected to the DOCK terminal of this unit (see page 18), you can enjoy playback of your iPod using the supplied remote control.

Supported iPod

iPod (Click and Wheel)

iPod nano

iPod mini

Battery charge feature

Your iPod battery is automatically charged when your iPod is stationed in a Yamaha iPod universal dock connected to the DOCK terminal of this unit as long as this unit is turned on.

Stationing your iPod to the Yamaha iPod universal dock

Once you station your iPod to the Yamaha iPod universal dock, “iPod connected” and the DOCK indicator appears in the front panel display when “V-AUX” is selected as the input source.

Controls and functions for iPod™

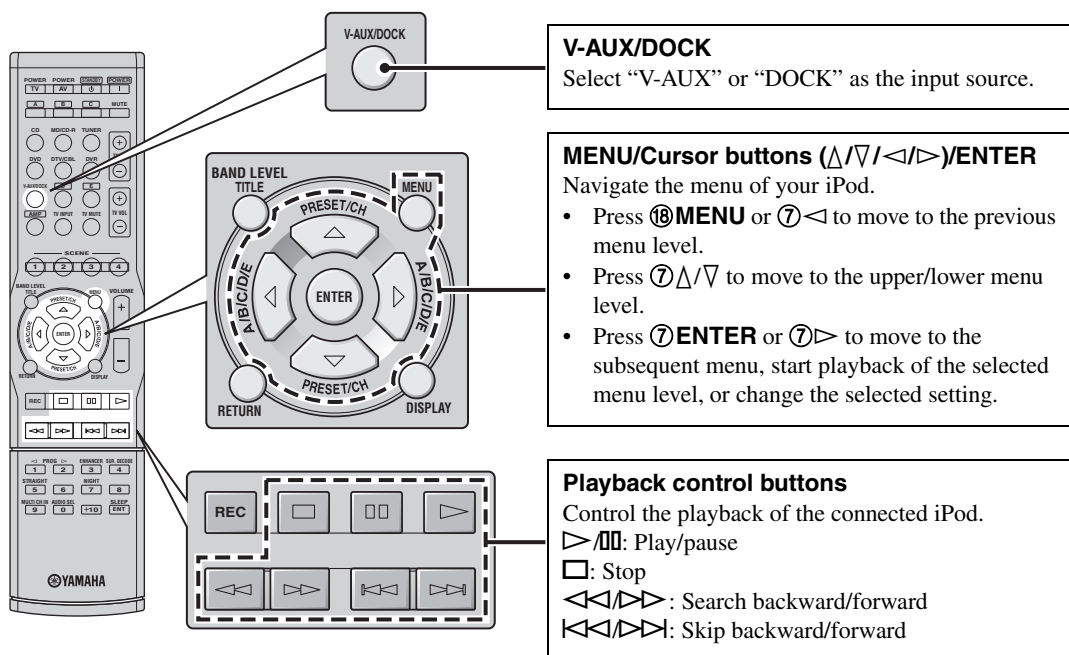

Notes

- Operations can be also done with the controls on your iPod. Refer to the instruction manuals of your iPod for the operations on your iPod.
- Some features may not be compatible depending on the model or the software version of your iPod.
- For a complete list of status messages that appear in the front panel display, see the “iPod” section in “Troubleshooting” on page 58.

Using Bluetooth™ components

You can connect a Yamaha Bluetooth adapter (such as YBA-10, sold separately) to the DOCK terminal of this unit and enjoy the music contents stored in your Bluetooth component (such as a portable music player) without wiring between this unit and the Bluetooth component. You need to perform “pairing” the connected Bluetooth adapter and your Bluetooth component in advance.

Pairing the Bluetooth™ adapter and your Bluetooth™ component

Pairing must be performed when using a Bluetooth component with the Bluetooth adapter connected to this unit for the first time or if the pairing data has been deleted. “Pairing” refers to the operation of registering a Bluetooth component for Bluetooth communications.



- You only need the pairing operation for the first time that you use the Bluetooth component with the Bluetooth adapter.
- Pairing requires operations on this unit and on the other component with which Bluetooth communications are to be established. If necessary, refer to the other component’s operating instructions.

There are two pairing methods: pairing by using “START PAIRING” in “SET MENU” and quick pairing.

■ Pairing by using “SET MENU”

Use this feature to perform pairing with the video monitor. Select “START PAIRING” in “INPUT MENU”. See page 50 for details.

■ Quick pairing

To ensure security, a time limit of 8 minutes is set for the pairing operation. You are recommended to read and fully understand all the instructions before starting.

1 Press **4 AMP** and then press **N INPUT** </> repeatedly (or press **3 V-AUX/DOCK**) to select “V-AUX” as the input source.

2 Turn on the Bluetooth component you want to pair with.

3 Press and hold **C BAND** (or **B BAND**) for 3 seconds.

Once the Bluetooth adapter starts pairing, “Searching...” appears for a moment. While the Bluetooth adapter is in the pairing mode, DOCK indicator flashes in the front panel display.



To cancel the pairing, press **C BAND** (or **B BAND**) again.

Note

If the Bluetooth adapter is not connected to the DOCK terminal of this unit, “No BT adapter” appears in the front panel display.

4 Check that the Bluetooth component detects the Bluetooth adapter.

If the Bluetooth component detects the Bluetooth adapter, “YBA-10 YAMAHA” (example) appears in the Bluetooth device list.

5 Select the Bluetooth adapter in the Bluetooth device list and then enter the pass key “0000” to the Bluetooth component.

When the pairing procedure is successful, “Completed” appears in the front panel display.

Note

The Yamaha Bluetooth adapter can be paired with up to eight other components. When pairing is conducted successfully with a ninth component and the pairing data is registered, the pairing data for the least recently used other component is cleared.

Playback of the Bluetooth™ component

1 Press **4 AMP** and then press **N INPUT** </> repeatedly (or press **3 V-AUX/DOCK**) to select “V-AUX” as the input source.

2 Start playback of your Bluetooth component. When the connected Bluetooth adapter detects the Bluetooth component, “BT connected” and the DOCK indicator appears in the front panel display.



- When you press **7 ENTER** on the remote control, the connected Bluetooth adapter searches and connect to the last connected Bluetooth component. If the Bluetooth adapter cannot find the Bluetooth component, “Not found” appears in the front panel display.
- To disconnect the Bluetooth adapter from the Bluetooth component, press **8 RETURN**.

Recording

Recording adjustments and other operations are performed from the recording components. Refer to the operating instructions for those components.

Notes

- When this unit is set to the standby mode, you cannot record between other components connected to this unit.
- The settings of TONE CONTROL (see page 31) and VOLUME settings, speaker levels (see page 32) and the sound field programs (see page 34) do not affect recorded material.
- The source connected to the MULTI CH INPUT jacks on this unit cannot be recorded.
- Digital signals input at the DIGITAL INPUT jacks are not output at the analog AUDIO OUT (REC) jacks for recording. Therefore, if your source component is connected to provide only digital signals, you cannot record the source.
- A given input source is not output on the same AUDIO OUT (REC) channel.
- The analog audio signals input at the DOCK terminal can be output at the analog AUDIO OUT (REC) jacks for recording.
- Once you have connected a recording component to this unit, keep the component turned on while using this unit. If the component is turned off, this unit may distort the sound from other components.
- Check the copyright laws in your country to record from CDs, radio, etc. Recording of copyrighted material may infringe copyright laws.



Do a test recording before you start an actual recording.

If you play back a video source that uses scrambled or encoded signals to prevent it from being dubbed, the picture itself may be disturbed due to those signals.

1 Turn on all the connected components.

2 Press **ⓃINPUT </> repeatedly (or press one of the input selector buttons (Ⓝ)) to select the source component you want to record from.**

3 Start playback on the selected source component or select a broadcast station.

4 Start recording on the recording component.

Set menu

You can use the following parameters in set menu to adjust a variety of system settings and customize the way this unit operates. Change the initial settings (indicated in bold under each parameter) to reflect the needs of your listening environment.

■ Basic setup BASIC SETUP

Use this feature to automatically adjust speaker and system parameters (see page 22).

■ Manual setup MANUAL SETUP

Use this feature to manually adjust speaker and system parameters.

Sound menu 1 SOUND MENU

Use this menu to manually adjust any speaker settings, alter the quality and tone of the sound output by the system or compensate for video signal processing delays when using LCD monitors or projectors.

Parameter	Features	Page
A)SPEAKER SET	Selects the size of each speaker, the speakers for low-frequency signal output, the crossover frequency, and the location of the front speakers connected to the FRONT B terminals.	45
B)SP LEVEL	Adjusts the output level of each speaker.	46
C)SP DISTANCE	Adjusts the distance of each speaker.	47
D)CENTER GEO	Adjusts the tonal quality of the center speaker.	47
E)LFE LEVEL	Adjusts the output level of the LFE channel for Dolby Digital or DTS signals.	47
F)D. RANGE	Adjusts the dynamic range of Dolby Digital or DTS signals.	47
G)AUDIO SET	Adjusts the muting level, audio delay settings, maximum volume level and initial volume level.	48

Input menu 2 INPUT MENU

Use this menu to manually reassign the input jacks, select the input mode or rename the input source.

Parameter	Features	Page
A)INPUT ASSIGN	Assigns the input jacks on this unit according to the component to be used.	48
B)INPUT RENAME	Changes the name of the input source.	49
C)VOLUME TRIM	Adjusts the output volume of each jack.	49
D)DECODER MODE	Selects the decoder mode for the sources connected to the DIGITAL INPUT jacks on the rear panel of this unit.	49
E)MULTI CH SET	Select the video source played in the background of the sources in put from the MULTI CH INPUT jacks.	49

Option menu 3 OPTION MENU

Use this menu to manually adjust the optional system parameters.

Parameter	Features	Page
A)DISPLAY SET	Adjusts the brightness of the front panel display.	50
B)MEMORY GUARD	Locks sound field program parameters and other set menu settings.	50
C)AUDIO SELECT	Designates the default audio input jack select setting mode for the input sources connected to the DIGITAL INPUT jacks when you turn on the power of this unit.	50
D)PARAM. INI	Sets all the parameters of the sound field programs to the initial factory settings.	50
E)BLUETOOTH	Pairs the connected Yamaha Bluetooth adapter (such as YBA-10, sold separately) with a Bluetooth component (see page 41).	50

■ Signal information

 SIGNAL INFO

Use this feature to check audio signal information (see page 32).

Using set menu

Use the remote control to access and adjust each parameter.



You can change the set menu parameters while this unit is reproducing sound.

- 1 Press **4** AMP and then press **19** MENU on the remote control.
“BASIC SETUP” appears in the front panel display.

• BASIC SETUP

- 2 Press **7** Δ / ▽ to select “MANUAL SETUP”.

• MANUAL SETUP

- 3 Press **7** ENTER to enter “MANUAL SETUP”.
“1 SOUND MENU” appears in the front panel display.

1 SOUND MENU

- 4 Press **7** Δ / ▽ repeatedly and then press **7** ENTER to select and enter the desired menu.

The following menus appear in the front panel display as you press **7** Δ / ▽ repeatedly.

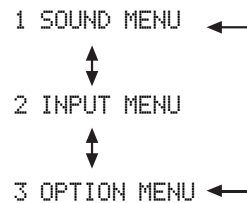

- 5 Press **7** Δ / ▽ repeatedly and then press **7** ENTER to select and enter the desired submenu.

- Repeat this step to navigate to and enter the items you want to adjust.
- To return to the previous menu level, press **18** RETURN.

- 6 Press **7** Δ / ▽ to select the desired parameter and then **7** < / > to change the parameter value.

- Press **7** > to increase the value.
- Press **7** < to decrease the value.

- 7 Press **18** MENU to exit from set menu.

1 SOUND MENU

Use this menu to manually adjust any speaker settings or compensate for video signal processing delays when using LCD monitors or projectors.

■ Speaker settings A) SPEAKER SET

Use this feature to manually adjust any speaker settings.

FRONT B speaker setting FRONT B

Use this feature to select the location of the front speakers connected to the FRONT B terminals.

Choices: **FRONT**, ZONE B

- Select "FRONT" to turn FRONT A and B on and off when the FRONT B speakers are set in the main zone.
- Select "ZONE B" if the speakers connected to the FRONT B terminals are set in another zone. If FRONT A is turned off and FRONT B is turned on, all the speakers including the subwoofer in the main zone are muted and this unit outputs sound at the FRONT B terminals only.

Notes

- If you connect headphones to the PHONES jack on this unit, the sound is output from both headphones and the FRONT B terminals when "FRONT B" is set to "ZONE B".
- If a DSP program is selected when "FRONT B" is set to "ZONE B", this unit automatically enters the Virtual CINEMA DSP mode (see page 36).

Woofer section of a speaker is 16 cm (6.5 in) or larger:
large
Woofer section of a speaker is smaller than 16 cm (6.5 in): small

Front speakers FRONT

Choices: **LARGE**, SMALL

When the front speakers are large

Select "LARGE" (large).

When the front speakers are small

Select "SMALL" (small).

Note

When "BASS OUT" is set to "FRNT" (see page 46), you can select only "LARGE" in "FRONT". If the value of "FRONT" is set to a setting other than "LARGE" in advance, this unit automatically changes the value to "LARGE".

Center speaker CENTER

Choices: NONE, **SML**, LRG

When the center speaker is large

Select "LRG" (large).

When the center speaker is small

Select "SML" (small).

When you do not use the center speaker

Select "NONE" (none). The center channel signals are directed to the front left and right speakers.

Surround left/right speakers SUR. LR

Choices: NONE, **SML**, LRG

When the surround speakers are large

Select "LRG" (large).

When the surround speakers are small

Select "SML" (small).

When you do not use the surround speakers

Select "NONE" (none). This unit is set to the Virtual CINEMA DSP mode (see page 36).

LFE/Bass out BASS OUT

Use this feature to select the speakers that output the LFE (low-frequency effect) and the low-frequency signals.

Choices: SWFR, FRNT, **BOTH**



If you are not satisfied with the bass sounds from your speakers, you can change these settings according to your preference.

When a subwoofer is connected to this unit and you want to get natural bass sound

Select “SWFR” (subwoofer). The LFE signals as well as the low-frequency signals of other speakers set to “SML” (or “SMALL”) are directed to the subwoofer.

When a subwoofer is connected to this unit and you want to get rich bass sound

Select “BOTH” (both). The low-frequency signals of any source are output from the subwoofer. The LFE signals as well as the low-frequency signals of other speakers set to “SML” (or “SMALL”) are directed to the subwoofer. The low-frequency signals of the front left and right channels are directed to the front left and right speakers and the subwoofer regardless of the “FRONT” setting (see page 45).

When you do not use a subwoofer

Select “FRNT” (front). The LFE signals, the low-frequency signals of the front left and right channels, and the low-frequency signals of other speakers set to “SML” (or “SMALL”) are all directed to the front left and right speakers regardless of the “FRONT” setting (see page 45).

Crossover CROSSOVER

Use this feature to select a crossover frequency of all the speakers set to “SML” (or “SMALL”) or to “NONE” in “SPEAKER SET” (see pages 44 and 45). All frequencies below the selected frequency will be sent to the subwoofer or to the speakers set to “LRG” (or “LARGE”) in “SPEAKER SET” (see pages 44 and 45).

Choices: 40Hz, 60Hz, **80Hz**, 90Hz, 100Hz, 110Hz, 120Hz, 160Hz, 200Hz

Subwoofer phase SWFR PHASE

Use this feature to switch the phase of your subwoofer if bass sounds are lacking or unclear.

Choices: **NRM**, REV

- Select “NRM” if you do not want to reverse the phase of your subwoofer.
- Select “REV” to reverse the phase of your subwoofer.

■ **Speaker level** B)SP LEVEL

Use this feature to manually adjust the output level of each speaker.

Control range: -10 to +10 dB

Control step: 1 dB

Initial setting: 0 dB

SP LEVEL	Adjusted speaker
FL	Front left speaker
FR	Front right speaker
C	Center speaker
SL	Surround left speaker
SR	Surround right speaker
SWFR	Subwoofer

Note

The available speaker channels differ depending on the setting of the speakers.

■ Speaker distance C)SP DISTANCE

Use this feature to manually adjust the distance of each speaker and the delay applied to the respective channel. Ideally, each speaker should be the same distance from the main listening position. However, this is not possible in most home situations. Thus, a certain amount of delay must be applied to the sound from each speaker so that all sounds will arrive at the listening position at the same time.

Unit UNIT

Choices: meters (m), feet (ft)

Initial setting:

[U.S.A. and Canada models]: feet (ft)

[Other models]: meters (m)

- Select “meters” to adjust speaker distances in meters.
- Select “feet” to adjust speaker distances in feet.

Speaker distances

Control range: 0.30 to 24.00 m (1.0 to 80.0 ft)

Control step: 0.10 m (0.5 ft)

Initial setting:

FRONT L/FRONT R/SWFR: 3.00 m (10.0 ft)

CENTER: 2.60 m (8.5 ft)

SUR. L/SUR. R: 2.40 m (8.0 ft)

SP DISTANCE	Adjusted speaker
FRONT L	Front left speaker
FRONT R	Front right speaker
CENTER	Center speaker
SUR. L	Surround left speaker
SUR. R	Surround right speaker
SWFR	Subwoofer

Note

The available speaker channels differ depending on the setting of the speakers.

■ Center graphic equalizer D)CENTER GEQ

Use this feature to adjust the built-in 5-frequency band (100Hz, 300Hz, 1kHz, 3kHz and 10kHz) graphic equalizer for the center channel so that the tonal quality of the center speaker matches that of the front speakers. You can make adjustments while listening to the currently selected source component or a test tone.

Control range: -6.0 to +6.0 dB

Control step: 0.5 dB

Initial setting: 0 dB



Press Δ / ∇ to select a frequency band and \leftarrow / \rightarrow to adjust the selected frequency band.

Following is an example where “100Hz” is selected as the frequency band.



Test tone TEST

Use this feature to make adjustments for “CENTER GEQ” while listening to a test tone.

Choices: **OFF**, ON

- Select “OFF” to stop test tones and output the currently selected source component.
- Select “ON” to output test tones from the center and front left speakers.

■ Low-frequency effect level E)LFE LEVEL

E)LFE LEVEL

Use this feature to adjust the output level of the LFE (low-frequency effect) channel according to the capacity of your subwoofer or headphones. The LFE channel carries low-frequency special effects which are only added to certain scenes. This setting is effective when the input signal contains the LFE channel.

Control range: -20 to 0 dB

Control step: 1 dB

Speaker LFE SP LFE

Adjusts the speaker LFE level.

Headphone LFE HP LFE

Adjusts the headphone LFE level.

Note

Depending on the settings of “BASS OUT” (see page 46), some signals may not be output at the SUBWOOFER OUTPUT jack.

■ Dynamic range F)D.RANGE

Use this feature to select the amount of dynamic range compression to be applied to your speakers or headphones. This setting is effective only when this unit is decoding Dolby Digital and DTS signals.

Choices: MIN, STD, **MAX**

- Select “MIN” (minimum) if you regularly listen at low volume levels.
- Select “STD” (standard) for general use.
- Select “MAX” (maximum) to preserve the greatest amount of dynamic range.

Speaker dynamic range SP D.R

Adjusts the speaker compression.

Headphone dynamic range HP D.R

Adjusts the headphone compression.

■ Audio settings G>AUDIO SET

Use this feature to adjust the overall audio settings of this unit.

Mute type MUTE TYP.

Use this feature to adjust how much the mute function reduces the output volume (see page 30).

Choices: **FULL**, -20dB

- Select “FULL” to completely mute all the audio output.
- Select “-20dB” to reduce the current volume by 20 dB.

Audio delay A.DELAY

Use this feature to delay the sound output and synchronize it with the video image. This may be necessary when using certain LCD monitors or projectors.

Control range: **0** to 160 ms

Control step: 1 ms

Maximum volume MAX VOL.

Use this feature to set the maximum volume level. This feature is useful to avoid the unexpected loud sound by mistake. For example, the original volume range is +16 dB to -80 dB. However, when “MAX VOL.” is set to -5 dB, the volume range becomes -5 dB to -80 dB.

Control range: **+16 dB**, +10 dB to -30 dB

Control step: 5 dB

Note

The “MAX VOL.” setting takes priority over the “Initial Volume” setting. For example, if “INI.VOL.” is set to -20 dB and “MAX VOL.” is set to -30 dB, the volume level is automatically set to -30 dB when you turn on the power of this unit next time.

Initial volume INI.VOL.

Use this feature to set the volume level when the power of this unit is turned on.

Choices: **Off**, -80 dB to +16 dB

Control step: 1 dB

Note

The “MAX VOL.” setting takes priority over the “INI.VOL.” setting.

2 INPUT MENU

Use this menu to reassign the input jacks, select the input mode or rename the input source.

■ Input assignment

A>INPUT ASSIGN

Use this feature to assign the input jacks according to the component to be used if the initial settings of this unit do not correspond to your needs. Change the following parameters to reassign the respective jacks and effectively connect more components.

Once the input jacks are reassigned, you can select the corresponding component by using **INPUT** </> (or the input selector buttons (③) on the remote control).

For DIGITAL INPUT COAXIAL jacks 1

IN (1)

Choices: (1) CD, MD/CD-R, **DVD**, DTV/CBL, V-AUX, DVR

For DIGITAL INPUT OPTICAL jacks 2 and 3

IN (2)

IN (3)

Choices: (2) CD, MD/CD-R, DVD, **DTV/CBL**, V-AUX, DVR

(3) **CD**, MD/CD-R, DVD, DTV/CBL, V-AUX, DVR

Notes

- You cannot select a specific item more than once.
- You cannot assign the same input source to both “IN (2)” and “IN (3)”. For example, you assign “CD” to “IN (2)”, “----” appears in “IN (3)”.

■ Input rename B>INPUT RENAME

Use this feature to change the name of the input source that appears in the front panel display.

The following is an example where “DVD” is renamed “My DVD”.



- 1 Press one of the input selector buttons (3) or 12 **MULTI CH IN** to select the input source you want to change the name of.

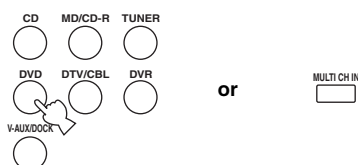

- 2 Press 4 **AMP** and then press 7 </> on the remote control to place the “_” (underscore) under the space or the character you want to edit.

- 3 Press 7 Δ / ▽ to select the character you want to use and then press 7 </> to move to the next space.

Notes

- You can use up to 8 characters for each input.
- Press 7 ▽ to change the character in the following order, or press 7 Δ to go in the reverse order:
A to Z, a space, 0 to 9, a space, a to z, a space, symbols (#, *, -, +, etc.)

- 4 Repeat steps 1 through 3 to rename each input source.

- 5 Press 10 **MENU** to exit from “INPUT RENAME”.

■ Volume trim C>VOLUME TRIM

Use this feature to adjust the level of the signal input at each jack. This is useful if you want to balance the level of each input source to avoid sudden changes in volume when switching between input sources.

Press one of the input selector buttons (3) or 12 **MULTI CH IN** to select the input source you want to adjust the level.

Choices: CD, TUNER, MD/CD-R, DVD, DTV/CBL, V-AUX (DOCK), DVR, MULTI CH IN

Control range: -6.0 to +6.0 dB

Control step: 1.0 dB

Initial setting: 0.0 dB

■ Decoder mode D>DECODER MODE

Decoder select mode

Use this feature to designate the default decoder mode for the input sources connected to the DIGITAL INPUT jacks when you turn on the power of this unit.

Choices: **AUTO**, **LAST**

- Select “AUTO” if you want this unit to automatically detect the type of input signals and select the appropriate decoder mode.
- Select “LAST” if you want this unit to automatically select the last decoder mode used the connected input source.

DTS decoder prioritize setting

Choices: **AUTO**, **DTS**

- Select “AUTO” if you want this unit to automatically detect input signal types and select the appropriate input mode.
- Select “DTS” when you play back a DTS-CD.

■ Multi channel input setup

E>MULTI CH SET

BGV BGV

Use this feature to select the video source played in the background of the sources input from the MULTI CH INPUT jacks.

Choices: **LAST**, DVR, V-AUX, DTV/CBL, DVD



Select “LAST” to set this unit to automatically select the last selected video source as the background video source.

3 OPTION MENU

Use this menu to adjust the optional system parameters.

■ Display settings A)DISPLAY SET

Dimmer DIMMER

Use this feature to adjust the brightness of the front panel display.

Control range: -4 to 0

Control step: 1

- Press **7**◀ to make the front panel display dimmer.
- Press **7**▶ to make the front panel display brighter.

■ Memory guard B)MEMORY GUARD

Memory guard MEM.GUARD

Use this feature to prevent accidental changes to DSP program parameter values and other system settings.

Choices: **OFF**, **ON**

- Select “OFF” to turn off the “MEM.GUARD” feature.
- Select “ON” to protect:
 - sound field program parameters
 - all set menu items
 - all speaker levels
 - SCENE template parameters

Note

When “MEM.GUARD” is set to “ON”, you cannot select and adjust any other set menu items.

■ Audio select C)AUDIO SELECT

Use this feature to designate the default audio input jack select setting for the input sources when you turn on the power of this unit.

Choices: **AUTO**, **LAST**

- Select “AUTO” if you want this unit to automatically detect the type of input signals and select the appropriate input mode.
- Select “LAST” if you want this unit to automatically select the last input mode used for the connected input source (see page 31).

■ Parameter initialization D)PARAM. INI

Use this feature to set all the parameters of the sound field programs to the initial factory settings.

Choices: **NO**, **YES**

- Select “NO” to cancel the parameter initialization and return to the previous menu level.
- Select “YES” to set all the sound field parameters to the initial factory settings.

Notes

- You cannot automatically revert to the previous parameter settings once you initialize the sound field program parameters.
- You cannot separately initialize individual sound field programs.

■ Bluetooth setting E)BLUETOOTH

Start pairing START PAIRING

Use this feature to start pairing the connected Yamaha Bluetooth adapter (such as YBA-10, sold separately) with your Bluetooth component. For details about the pairing, refer to “Pairing the Bluetooth™ adapter and your Bluetooth™ component” on page 41.

To ensure security, a time limit of 8 minutes is set for the pairing operation. You are recommended to read and fully understand all the instructions before starting.

1 Select “START PAIRING” in “BLUETOOTH” and then press **7**ENTER to start pairing.

The connected Bluetooth adapter starts searching Bluetooth components. “Searching...” appears in the front panel display.

2 Check that the Bluetooth component detects the Bluetooth adapter.

If the Bluetooth component the Bluetooth adapter, “YBA-10 YAMAHA” (example) appears in the Bluetooth device list.

3 Select the Bluetooth adapter in the Bluetooth device list and then enter the pass key “0000” on the Bluetooth component.

Once this unit completes the pairing successfully, “Completed” appears.



To cancel the pairing, press **8**RETURN to exit from “START PAIRING”.

4 Press **8**RETURN to exit from “START PAIRING”.

Notes

- If the connected Bluetooth adapter cannot find any Bluetooth components, “Not found” appears.
- If a Bluetooth adapter is not connected to this unit, “No BT adapter” appears.

Remote control features

In addition to controlling this unit, the remote control can also operate other audiovisual components made by Yamaha and other manufacturers. To control your TV or other components, you must set up the appropriate remote control code for each input source (see page 53).

Controlling this unit, a TV, or other components

Controlling this unit

Press **④AMP** to control this unit.

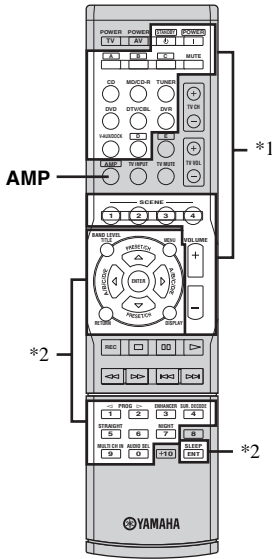

Controlling a TV

Press **③DTV/CBL** to control your TV. To control your TV, set the appropriate remote control code for **③DTV/CBL** (see page 53).

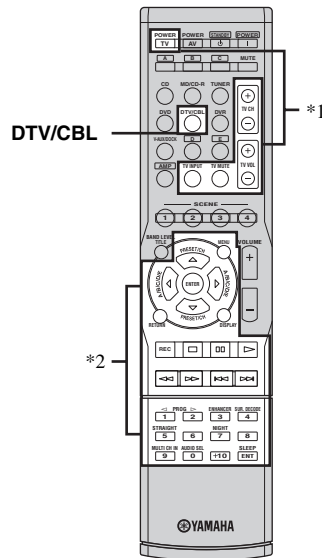

Notes

- *1 These buttons always control this unit.
- *2 These buttons control this unit only when **④AMP** is pressed.

Notes

- *1 These buttons always control your TV regardless of whether you press **③DTV/CBL** or not.

Remote control	Digital TV/Cable TV
TV POWER	Turns on or off the power.
TV CH +/-	Changes the channel number.
TV VOL +/-	Increases or decreases the volume level.
TV INPUT	Changes the input source.
TV MUTE	Mutes the audio output.

- *2 These buttons control your TV only when **③DTV/CBL** is pressed. For details, see the “Digital TV/Cable TV” column on page 52.



You can control more than one TV by setting the appropriate remote control code for any input source selector buttons other than **③DTV/CBL**. In such a case, you can control the buttons highlighted above (*1 and *2) when you press the input source selector button.

■ Controlling other components

Press one of the input selector buttons (A-E) or A to E buttons to control other components. You must set the appropriate remote control code for each input source in advance (see page 53). The following table shows the function of each control button used to control other components assigned to each input selector button. Be advised that some buttons may not correctly operate the selected component.



- The remote control has 13 modes (input areas) to control components so that the remote control can operate up to 13 different components.
- When you press one of the optional component control area buttons (A to E), you can control the desired component without changing the input source of this unit.

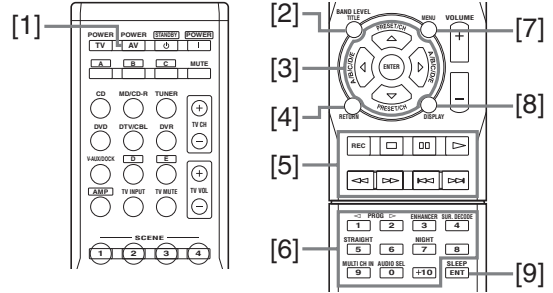

Remote control	DVD player/recorder	VCR	Digital TV/Cable TV	LD player	CD player	MD/CD recorder	Tuner
[1] AV POWER	Power *1	Power *1	Power *2	Power *1	Power *1	Power *1	
[2] TITLE	Title						Band
[3] PRESET/CH Δ	Up	VCR channel up	Up				Preset up (1-8)
PRESET/CH ∇	Down	VCR channel down	Down				Preset down (1-8)
A/B/C/D/E ◀	Left		Left				Preset down (A-E)
A/B/C/D/E ▶	Right		Right				Preset up (A-E)
ENTER	Enter		Enter				
[4] RETURN	Return		Return				
[5] REC	Disc skip (player) Rec (recorder)	Rec	Rec *2		Disc skip	Rec	
▷	Play	Play	Play *2	Play	Play	Play	
◀◀	Search backward	Search backward	Search backward *2	Search backward	Search backward	Search backward	
▶▶	Search forward	Search forward	Search forward *2	Search forward	Search forward	Search forward	
⏸	Pause	Pause	Pause *2	Pause	Pause	Pause	
◀◀◀	Skip backward	Skip backward	Skip backward *2	Skip backward	Skip backward	Skip backward	
▶▶▶	Skip forward	Skip forward	Skip forward *2	Skip forward	Skip forward	Skip forward	
□	Stop	Stop	Stop *2	Stop	Stop	Stop	
[6] 1-9, 0, +10	Numeric buttons	Numeric buttons	Numeric buttons	Numeric buttons	Numeric buttons	Numeric buttons	Preset stations (1-8)
[7] MENU	Menu		Menu				
[8] DISPLAY	Display	Display	Display	Display	Display	Display	
[9] ENT	Title/Index	Enter	Enter	Chapter/Time	Index	Index	

Notes

*1 This button is operational only when the original remote control supplied with the component has a POWER button.

*2 These buttons operate your DVD recorder only when you set the appropriate remote control code for DVR (see page 53).

Setting remote control codes

You can control other components by setting the appropriate remote control codes. For a complete list of available remote control codes, refer to “List of remote control codes” at the end of this manual.

Remote control code default settings

Input source	Component category	Manufacturer	Default code
CD	CD	Yamaha	5013
MD/CD-R	CD-R	Yamaha	5001
TUNER	TUNER	Yamaha	5007
DVD	DVD	Yamaha	2000
DTV/CBL	—	—	—
V-AUX/D OCK	TUNER	Yamaha	5011
DVR	DVR	Yamaha	2011
A	TUNER	Yamaha	5012
B	TUNER	Yamaha	5009
C	TUNER	Yamaha	5017
D	—	—	—
E	—	—	—

Note

You may not be able to operate your Yamaha component even if a Yamaha remote control code is preset as listed above. In this case, try setting another Yamaha remote control code.

- 1 While pressing and holding one of the input selector buttons (③) on the remote control to select the input area you want to set up, press ② **AV POWER** for more than 3 seconds.

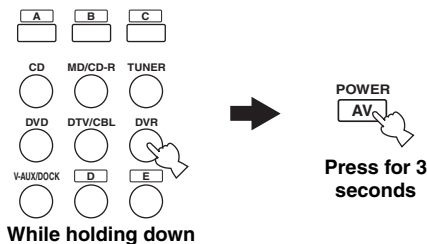

- 2 Press the numeric buttons (0 to 9) (④) to enter the four-digit remote control code for the component to be used.

When the setting succeeds, “RemoteSetup OK” appears; however, when it does not, “RemoteSetup NG” appears in the front panel display.

Notes

- If the manufacturer of your component has more than one code, try each of them until you find the correct one.
- If you do not press any buttons within 30 seconds in step 2, the setup process is canceled. If this happens, repeat the setup procedure.

Resetting all remote control codes

Use this feature to clear all the remote control codes previously set and reset all of them to the initial factory settings.

- 1 While pressing and holding ④ **AMP**, press ② **AV POWER** for more than 3 seconds.

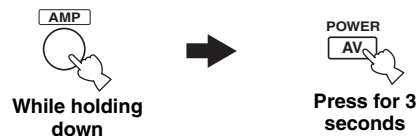

- 2 Press the numeric buttons (④) to enter the code number “9981”.

“RemoteSetup OK” appears in the front panel display, and the remote control codes previously set are cleared and reset to the initial factory settings.



If you do not press any buttons within 30 seconds after step 1, the clearing process is canceled. In this case, repeat the clearing procedure.

Advanced setup

This unit has additional menus that are displayed in the front panel display. The advanced setup menu offers additional operations to adjust and customize the way this unit operates. Change the initial settings (indicated in bold under each parameter) to reflect the needs of your listening environment.

Notes

- Only **Ⓐ**STANDBY/ON, **Ⓚ**PROGRAM $\triangleleft/\triangleright$ and **Ⓛ**STRAIGHT are effective while you are using the advanced setup menu.
- No other operations can be made while you are using the advanced setup menu.
- The advanced setup menu is only available in the front panel display.

1 Press **ⒶSTANDBY/ON on the front panel to set this unit to the standby mode.**

2 Press and hold **ⓂTONE CONTROL and then press **Ⓐ**STANDBY/ON to turn on this unit.**

This unit turns on, and the advanced setup menu appears in the front panel display.

3 Press **ⓀPROGRAM $\triangleleft/\triangleright$ to select the parameter you want to adjust.**
The name of the selected parameter appears in the front panel display.

4 Press **ⓁSTRAIGHT repeatedly to change the selected parameter setting.**

5 Press **ⒶSTANDBY/ON to confirm your selection and set this unit to the standby mode.**



The settings you made are reflected next time you turn on this unit.

■ Speaker impedance SP IMP. (U.S.A. and Canada models only)

Use this feature to set the speaker impedance of this unit so that it matches that of your speakers.

Choices: **8ΩMIN**, 6ΩMIN

- Select “8ΩMIN” to set the speaker impedance to 8 Ω.
- Select “6ΩMIN” to set the speaker impedance to 6 Ω.

SP IMP.	Speaker	Impedance level
8ΩMIN	Front (A or B)	The impedance of each speaker must be 8 Ω or higher.
	Center	
	Surround	
6ΩMIN	Front (A or B)	The impedance of each speaker must be 6 Ω or higher.
	Center	
	Surround	

■ Tuner frequency step TU (Asia and General models only)

Use this feature to set the tuner frequency step according to the frequency spacing in your area.

Choices: **AM10/FM100**, AM9/FM50

- Select “AM10/FM100” for North, Central and South America.
- Select “AM9/FM50” for all other areas.

■ Initializing PRESET

Use this feature to reset all the parameters of this unit to the initial factory settings.

Choices: **CANCEL**, RESET

- Select “CANCEL” not to reset any parameters of this unit.
- Select “RESET” to reset the parameters of this unit.

Notes

- This setting completely resets all the parameters of this unit including the set menu parameters. However, the advanced setup menu parameters will not be initialized.
- The initial factory settings are activated next time you turn on this unit.

Troubleshooting

Refer to the table below when this unit does not function properly. If the problem you are experiencing is not listed below or if the instruction below does not help, turn off this unit, disconnect the power cable, and contact the nearest authorized Yamaha dealer or service center.

■ General

Problem	Cause	Remedy	See page
This unit fails to turn on or enters the standby mode soon after the power is turned on.	The power cable is not connected or the plug is not completely inserted.	Connect the power cable firmly.	—
	The speaker impedance setting is incorrect.	Set the speaker impedance to match your speakers.	12
	The protection circuitry has been activated.	Make sure that all speaker wire connections on this unit and on all speakers are secure and that the wire for each connection does not touch anything other than its respective connection.	11
	This unit has been exposed to a strong external electric shock (such as lightning or strong static electricity).	Set this unit to the standby mode, disconnect the power cable, plug it back in after 30 seconds and then use it normally.	—
No sound	Incorrect input or output cable connections.	Connect the cables properly. If the problem persists, the cables may be defective.	13-17
	No appropriate Audio input jack select has been set.	Set an appropriate Audio input jack select.	31
	No appropriate input source has been selected.	Select an appropriate input source with Ⓜ INPUT < /> on the front panel (or the input selector buttons (Ⓜ) on the remote control).	29, 30
	Speaker connections are not secure.	Secure the connections.	11
	The front speakers to be used have not been selected properly.	Select the front speakers with Ⓜ SPEAKERS.	29
	The volume is turned down.	Turn up the volume.	—
	The sound is muted.	Press Ⓜ MUTE or Ⓜ VOLUME +/- on the remote control to resume audio output and then adjust the volume.	30
	Signals this unit cannot reproduce are being input from a source component, such as a CD-ROM.	Play a source whose signals can be reproduced by this unit.	—
	Audio signals input at the HDMI jack are not output from any speaker terminals.	Make an analog or digital connection beside the HDMI connection.	—
	The setting of the connected component is improper.	Make an appropriate setting following the instruction manual of the connected component.	—
The sound suddenly goes off.	The protection circuitry has been activated because of a short circuit, etc.	Check that the impedance setting is correct.	12
		Check that the speaker wires are not touching each other and then turn this unit back on.	—
	The sleep timer has turned off this unit.	Turn on this unit, and play the source again.	—
	The sound is muted.	Press Ⓜ MUTE or Ⓜ VOLUME +/- on the remote control to resume audio output.	30
Sound is heard from the speaker on one side only.	Incorrect cable connections.	Connect the cables properly. If the problem persists, the cables may be defective.	13-17
	Incorrect settings in “SP LEVEL”.	Adjust the “SP LEVEL” settings.	32

Problem	Cause	Remedy	See page
Only the center speaker outputs substantial sound.	When playing a monaural source with a CINEMA DSP program, the source signal is directed to the center channel, and the front and surround speakers output effect sounds.		
No sound is heard from the center speaker.	“CENTER” in “SPEAKER SET” is set to “NONE”.	Set “CENTER” to “SML” or “LRG”.	45
	Some sound field programs do not output sounds from the center speaker.	Try another sound field program.	34
No sound is heard from the surround speakers.	“SUR. LR” in “SPEAKER SET” is set to “NONE”.	Set “SUR. LR” to “SML” or “LRG”.	45
	This unit is in the “STRAIGHT” mode and a monaural source is being played back.	Press ⓪STRAIGHT on the front panel so that “STRAIGHT” disappears from the front panel display.	36
No sound is heard from the subwoofer.	“BASS OUT” in “SPEAKER SET” is set to “FRNT” when a Dolby Digital or DTS signal is being played.	Set “BASS OUT” to “SWFR” or “BOTH”.	46
	“BASS OUT” in “SPEAKER SET” is set to “SWFR” or “FRNT” when a 2-channel source is being played.	Set “BASS OUT” to “BOTH”.	46
	The source does not contain low-frequency bass signals.		
Dolby Digital or DTS sources cannot be played. (Dolby Digital or DTS indicator in the front panel display does not light up.)	The connected component is not set to output Dolby Digital or DTS digital signals.	Make an appropriate setting following the operating instructions for your component.	—
	Audio input jack select is set to “ANALOG”.	Set Audio input jack select to “AUTO”.	31
A humming sound is heard.	Incorrect cable connections.	Connect the audio cables firmly. If the problem persists, the cables may be defective.	—
The volume level cannot be increased, or the sound is distorted.	You are attempting to set the volume level higher than the maximum volume level.	Adjust “MAX VOL.” setting.	48
	The component connected to the AUDIO OUT (REC) jacks on this unit is turned off.	Turn on the power of the component.	—
The sound effect cannot be recorded.	It is not possible to record the sound effect with a recording component.		
A source cannot be recorded by an analog component connected to the AUDIO OUT (REC) jacks.	The source component is not connected to the analog AUDIO IN jacks on this unit.	Connect the source component to the analog AUDIO IN jacks.	15, 17
The sound field parameters and some other settings of this unit cannot be changed.	“MEM.GUARD” in “OPTION MENU” is set to “ON”.	Set “MEM.GUARD” to “OFF”.	50
This unit does not operate properly.	The internal microcomputer has been frozen by an external electric shock (such as lightning or excessive static electricity) or by a power supply with low voltage.	Disconnect the power cable from the AC wall outlet and then plug it in again after about 30 seconds.	—
“CHECK SP WIRES” appears in the front panel display.	Speaker cables are short-circuited.	Make sure all speaker cables are connected correctly.	11

Problem	Cause	Remedy	See page
There is noise interference from digital or radio frequency equipment.	This unit is too close to the digital or high-frequency equipment.	Move this unit further away from such equipment.	—
The picture is disturbed.	The video source uses scrambled or encoded signals to prevent dubbing.		
This unit suddenly enters the standby mode.	The internal temperature is too high and the overheat protection circuitry has been activated.	Wait about 1 hour for this unit to cool down and then turn it back on.	—

■ Tuner

Problem	Cause	Remedy	See page		
FM	FM stereo reception is noisy.	The characteristics of FM stereo broadcasts may cause this problem when the transmitter is too far away or the antenna input is poor.	Check the antenna connections. Try using a high-quality directional FM antenna. Use the manual tuning method.	19 — 37	
		There is distortion, and clear reception cannot be obtained even with a good FM antenna.	There is multi-path interference.	Adjust the antenna position to eliminate multi-path interference.	—
		The desired station cannot be tuned into with the automatic tuning method.	The signal is too weak.	Use a high-quality directional FM antenna. Use the manual tuning method.	— 37
	Previously preset stations can no longer be tuned into.	This unit has been disconnected for a long period.	Set preset stations.	38	
AM	The desired station cannot be tuned into with the automatic tuning method.	The signal is weak or the antenna connections are loose.	Tighten the AM loop antenna connections and orient it for the best reception. Use the manual tuning method.	— 37	
		There are continuous crackling and hissing noises.	Noises result from lightning, fluorescent lamps, motors, thermostats and other electrical equipment.	Use an outdoor antenna and a ground wire. This will help somewhat, but it is difficult to eliminate all noise.	—
	There are buzzing and whining noises.	A TV set is being used nearby.	Move this unit away from the TV set.	—	

■ iPod

Note

In case of a transmission error without a status message appearing in the front panel display, check the connection to your iPod (see page 18).

Status message	Cause	Remedy	See page
Connect error	There is a problem with the signal path from your iPod to this unit.	Turn off this unit and reconnect the Yamaha iPod universal dock to the DOCK terminal of this unit. Try resetting your iPod.	18 —
Unknown iPod	The iPod being used is not supported by this unit.	Only iPod (Click and Wheel), iPod nano, and iPod mini are supported.	—
iPod connected	Your iPod is properly stationed in a Yamaha iPod universal dock (such as YDS-10, sold separately) connected to the DOCK terminal of this unit, and the connection between your iPod and this unit is complete.		
Disconnected	Your iPod was removed from a Yamaha iPod universal dock (such as YDS-10, sold separately) connected to the DOCK terminal of this unit.	Station your iPod back in a Yamaha iPod universal dock (such as YDS-10, sold separately) connected to the DOCK terminal of this unit.	18

■ Bluetooth

Status message	Cause	Remedy	See page
Searching...	The Bluetooth adapter and the Bluetooth component is in the middle of the pairing. The Bluetooth adapter and the Bluetooth component is in the middle of establishing the connection.		
Completed	The pairing is completed.		
Canceled	The pairing is canceled.		
BT connected	The connection between the Yamaha Bluetooth adapter (such as YBA-10, sold separately) and the Bluetooth component is established.		
Disconnected	The Bluetooth component is disconnected from the Bluetooth adapter (such as YBA-10, sold separately).		
No BT adapter	The Bluetooth adapter is not connected to the DOCK terminal.	Connect the Yamaha Bluetooth adapter (such as YBA-10, sold separately) to the DOCK terminal.	18

■ Remote control

Problem	Cause	Remedy	See page
The remote control does not work nor function properly.	Wrong distance or angle.	The remote control functions within a maximum range of 6 m (20 ft) and no more than 30 degrees off-axis from the front panel.	21
	Direct sunlight or lighting (from an inverter type of fluorescent lamp, etc.) is striking the remote control sensor of this unit.	Reposition this unit.	—
	The batteries are weak.	Replace all batteries.	3
	The remote control code is not correctly set.	Set the remote control code correctly using “List of remote control codes” at the end of this manual.	53
		Try setting another code for the same manufacturer using “List of remote control codes” at the end of this manual.	53
Even if the remote control code is correctly set, there are some models that do not respond to the remote control.			

■ Resetting the system

Use this feature to reset all the parameters of this unit to the initial factory settings.

1 Press  STANDBY/ON on the front panel to set this unit to the standby mode.

2 Press and hold  TONE CONTROL and then press  STANDBY/ON to turn on this unit.

The advanced setup menu appears in the front panel display.

3 Press  PROGRAM  /  to select “PRESET”.

4 Press  STRAIGHT repeatedly to select “RESET”.



Select “CANCEL” to cancel the initialization procedure without making any changes.

5 Press  STANDBY/ON to confirm your selection and set this unit to the standby mode.

Notes

- This procedure completely resets all the parameters of this unit including the set menu parameters.
- The initial factory settings are activated next time you turn on this unit.



To cancel the initialization procedure at any time without making any changes, press  STRAIGHT repeatedly to select “CANCEL” and then press  STANDBY/ON.

Glossary

■ Audio information

Dolby Digital

Dolby Digital is a digital surround sound system that gives you completely independent multi-channel audio. With 3 front channels (front L/R and center), and 2 surround stereo channels, Dolby Digital provides 5 full-range audio channels. With an additional channel especially for bass effects, called LFE (Low Frequency Effect), the system has a total of 5.1-channels (LFE is counted as 0.1 channel). By using 2-channel stereo for the surround speakers, more accurate moving sound effects and surround sound environment are possible than with Dolby Surround. The wide dynamic range from maximum to minimum volume reproduced by the 5 full-range channels and the precise sound orientation generated using digital sound processing provide listeners with unprecedented excitement and realism. With this unit, any sound environment from monaural up to a 5.1-channel configuration can be freely selected for your enjoyment.

Dolby Pro Logic II

Dolby Pro Logic II is an improved technique used to decode vast numbers of existing Dolby Surround sources. This new technology enables a discrete 5-channel playback with 2 front left and right channels, 1 center channel, and 2 surround left and right channels instead of only 1 surround channel for conventional Pro Logic technology. There are three modes available: “Music mode” for music sources, “Movie mode” for movie sources and “Game mode” for game sources.

Dolby Surround

Dolby Surround uses a 4-channel analog recording system to reproduce realistic and dynamic sound effects: 2 front left and right channels (stereo), a center channel for dialog (monaural), and a surround channel for special sound effects (monaural). The surround channel reproduces sound within a narrow frequency range. Dolby Surround is widely used with nearly all video tapes and laser discs, and in many TV and cable broadcasts as well. The Dolby Pro Logic decoder built into this unit employs a digital signal processing system that automatically stabilizes the volume on each channel to enhance moving sound effects and directionality.

DTS Digital Surround

DTS digital surround was developed to replace the analog soundtracks of movies with a 5.1-channel digital sound track, and is now rapidly gaining popularity in movie theaters around the world. DTS, Inc. has developed a home theater system so that you can enjoy the depth of sound and natural spatial representation of DTS digital surround in your home. This system produces practically distortion-free 5.1-channel sound (technically, left, right and center channels, 2 surround channels, plus an LFE 0.1 channel as a subwoofer, for a total of 5.1-channels).

LFE 0.1 channel

This channel reproduces low-frequency bass signals. The frequency range of this channel is from 20 Hz to 120 Hz. This channel is counted as 0.1 because it only enforces a low-frequency range compared to the full-range reproduced by the other 5 channels in Dolby Digital or DTS 5.1-channel systems.

PCM (Linear PCM)

Linear PCM is a signal format under which an analog audio signal is digitized, recorded and transmitted without using any compression. This is used as a method of recording CDs and DVD audio. The PCM system uses a technique for sampling the size of the analog signal per very small unit of time. Standing for “Pulse Code Modulation”, the analog signal is encoded as pulses and then modulated for recording.

Sampling frequency and number of quantized bits

When digitizing an analog audio signal, the number of times the signal is sampled per second is called the sampling frequency, while the degree of fineness when converting the sound level into a numeric value is called the number of quantized bits. The range of rates that can be played back is determined based on the sampling rate, while the dynamic range representing the sound level difference is determined by the number of quantized bits. In principle, the higher the sampling frequency, the wider the range of frequencies that can be played back, and the higher the number of quantized bits, the more finely the sound level can be reproduced.

■ Sound field program information

CINEMA DSP

Since the Dolby Surround and DTS systems were originally designed for use in movie theaters, their effect is best felt in a theater having many speakers designed for acoustic effects. Since home conditions, such as room size, wall material, number of speakers, and so on, can differ so widely, it is inevitable that there are differences in the sound heard. Based on a wealth of actually measured data, Yamaha CINEMA DSP uses Yamaha original DSP technology to combine Dolby Pro Logic, Dolby Digital and DTS systems to provide the audiovisual experience of movie theater in the listening room of your own home.

SILENT CINEMA

Yamaha has developed a natural, realistic sound effect DSP algorithm for headphones. Parameters for headphones have been set for each sound field program so that accurate representations of all the sound field programs can be enjoyed on headphones.

Virtual CINEMA DSP

Yamaha has developed a Virtual CINEMA DSP algorithm that allows you to enjoy DSP surround effects even without any surround speakers by using virtual surround speakers. It is even possible to enjoy Virtual CINEMA DSP using a minimal two-speaker system that does not include a center speaker.

■ Video information

Component video signal

With the component video signal system, the video signal is separated into the Y signal for the luminance and the P_B and P_R signals for the chrominance. Color can be reproduced more faithfully with this system because each of these signals is independent. The component signal is also called the “color difference signal” because the luminance signal is subtracted from the color signal. A monitor with component input jacks is required in order to output component signals.

Composite video signal

With the composite video signal system, the video signal is composed of three basic elements of a video picture: color, brightness and synchronization data. A composite video jack on a video component transmits these three elements combined.

Specifications

AUDIO SECTION

- Minimum RMS Output Power for Front, Center, Surround
[U.S.A. and Canada models]
1 kHz, 0.9% THD, 8 Ω 100 W/ch
[Other models]
1 kHz, 0.9% THD, 6 Ω 100 W/ch
- Maximum Power (JEITA)
[U.S.A. and Canada models]
1 kHz, 10% THD, 8 Ω 135 W/ch
[Asia, China, Korea and General models]
1 kHz, 10% THD, 6 Ω 135 W/ch
- MAX Power Per Channel
[U.K., Russia, and Europe models]
1 kHz, 0.7% THD, 4 Ω 105 W or more
- IEC Power
[U.K., Russia, and Europe models]
1 kHz, 0.1% THD, 6 Ω 90 W or more
- Dynamic Power
[U.S.A. and Canada models] (Impedance Selector: 8 Ω)
(IHF, 8/6/4/2 Ω) 110/130/160/180 W
[Other models]
(IHF, 6/4/2 Ω) 105/130/150 W
- Dynamic Headroom [U.S.A. and Canada models]
8 Ω 0.41 dB
- Frequency Response
CD, etc. to Front 10 Hz to 100 kHz, 0–3 dB
V-AUX to Front 10 Hz to 20 kHz, 0–3 dB
- Total Harmonic Distortion
CD, etc. (2ch stereo) to Front SP OUT,
[U.S.A. and Canada models]
1 kHz, 50 W/8 Ω 0.06% or less
[Other models]
1 kHz, 50 W/6 Ω 0.06% or less
- Signal to Noise Ratio (IHF-A Network)
CD, etc. (STEREO) Input shorted
250 mV 100 dB or more
200 mV 98 dB or more
- Residual Noise (IHF-A Network)
Front L/R 170 μV or less
- Channel Separation
CD, etc. Input 5.1 kΩ shorted (1 kHz/10 kHz)
..... 60 dB/45 dB or more
- Tone Control
BASS Boost/Cut ±10 dB/100 Hz
TREBLE Boost/Cut ±10 dB/20 kHz
- Headphone Jack Rated Output/Impedance
CD, etc. (1 kHz, 200 mV, 8 Ω) 0.4 V/470 Ω
- Input Sensitivity/Input Impedance
CD, etc. 200 mV/47 kΩ
MULTI CH INPUT 200 mV/47 kΩ
- Maximum Input Signal
CD, etc. 1 kHz, 0.5% THD (EFFECT ON) 2.0 V or more
- Output Level/Output Impedance
AUDIO OUT (REC) 200 mV/1.2 kΩ
SUBWOOFER OUTPUT
(2ch Stereo and FRONT SP: SMALL) 4 V/1.2 kΩ
- Filter Characteristics (fc=40/60/80/90/100/110/120/160/200 Hz)
H.P.F. (Front, Center, Surround) 12 dB/oct.
L.P.F. (Subwoofer) 24 dB/oct.

VIDEO SECTION

- Signal Level
Composite 1 Vp-p/75 Ω
Component 1 Vp-p/75 Ω (Y), 0.7 Vp-p/75 Ω (Pb/Pk)
- Video Maximum Input Level 1.5 Vp-p or more
- Signal to Noise Ratio 50 dB or more
- Frequency Response (MONITOR OUT)
Component Signal 5 Hz to 60 MHz, –3 dB

FM SECTION

- Tuning Range
[U.S.A. and Canada models] 87.5 to 107.9 MHz
[Asia and General models] 87.5/87.50 to 108.0/108.00 MHz
[Other models] 87.50 to 108.00 MHz
- 50 dB Quieting Sensitivity (IHF, 100% mod.)
Mono 2.8 μV (20.2 dBf)
- Signal to Noise Ratio (IHF)
Mono/Stereo 73 dB/70 dB
- Harmonic Distortion (1 kHz)
Mono/Stereo 0.5%/0.5%

AM SECTION

- Tuning Range
[U.S.A. and Canada models] 530 to 1710 kHz
[Asia and General models] 530/531 to 1710/1611 kHz
[Other models] 531 to 1611 kHz

GENERAL

- Power Supply
[U.S.A. and Canada models] 120 V AC, 60 Hz
[Australia model] 240 V AC, 50 Hz
[Korea model] 220 V AC, 60 Hz
[China model] 220 V AC, 50 Hz
[U.K., Russia, and Europe models] 230 V AC, 50 Hz
[Asia and General models]
..... 110-120/220–240 V AC, 50/60 Hz
- Power Consumption
[U.S.A. and Canada models] 240 W/320 VA
[Other models] 240 W
- Standby Power Consumption
[Except Asia and General models] 0.8 W
- Maximum Power Consumption
[Asia and General models]
5ch, 10%/THD 530 W
- Dimensions (W x H x D) 435 x 151 x 318 mm
(17-1/8" x 5-15/16" x 12-1/2")
- Weight 8.0 kg (17 lbs 10 oz)

* Specifications are subject to change without notice.

Index

■ Numerics

1 SOUND MENU	43, 45
2 INPUT MENU	43, 48
2ch Stereo	34
3 OPTION MENU	44, 50
5ch Stereo	34

■ A

A)DISPLAY SET	50
A)INPUT ASSIGN	48
A)SPEAKER SET	45
A.DELAY	48
Adjusting speaker levels during playback	32
Adjusting the tonal quality	31
AM tuning	37
ANTENNA terminals	9
Audio cable plugs	13
Audio delay	48
AUDIO jacks	9, 13
Audio jacks	13
AUDIO SELECT	31
Audio select	50
Audio settings	48
Automatic preset tuning	38
Automatic tuning	37

■ B

B)INPUT RENAME	49
B)MEMORY GUARD	50
B)SP LEVEL	46
BASIC SETUP	22, 43
Basic setup	43
BASS OUT	46
BGV	49
Bluetooth setting	50
Bluetooth status message	58
BT connected, Bluetooth status message	58

■ C

C)AUDIO SELECT	50
C)SP DISTANCE	47
C)VOLUME TRIM	49
Canceled, Bluetooth status message	58
CD Listening	26
CD Music Listening	26
CENTER	45
Center graphic equalizer	47
Center speaker	45
Center width	35
CINEMA DSP indicator	20
Completed, Bluetooth status message	58
COMPONENT VIDEO jacks	9, 13
Connect error, iPod controlling status message	58
Connecting a cable TV/satellite tuner	15

Connecting a CD player	17
Connecting a CD player and a CD recorder/MD recorder	17
Connecting a DVD player	15
Connecting a DVD recorder	15
Connecting a video monitor	15
Connecting audio components	17
Connecting speakers	11
Connecting the AM antennas	19
Connecting the FM antennas	19
Connecting the power cable	19
Connecting the Yamaha Bluetooth adapter	18
Connecting the Yamaha iPod universal dock	18
Connecting to the CENTER terminals	12
Connecting to the COMPONENT VIDEO jacks	16
Connecting to the FRONT A terminals	12
Connecting to the FRONT B terminals	12
Connecting to the HDMI or COMPONENT VIDEO jacks	16
Connecting to the MULTI CH INPUT jacks	17
Connecting to the SURROUND terminals	12
Connecting to the VIDEO AUX jacks	18
Connecting video components	15
Controlling a TV	51
Controlling other components	52
Creating original SCENE templates	27
CROSSOVER	46
Crossover	46
CT WIDTH	35

■ D

D)CENTER GEQ	47
D)DECODER MODE	49
D)PARAM. INI	50
Decoder indicator	20
Decoder mode	49
Decoder select mode	49
DIGITAL AUDIO COAXIAL jacks	13
DIGITAL AUDIO OPTICAL jacks	13
DIGITAL INPUT COAXIAL assignment	48
DIGITAL INPUT jacks	9
DIGITAL INPUT OPTICAL assignment	48
DIMENSION	35
Dimension	35
DIMMER	50
Dimmer	50
Disc Listening	26

Disconnected, Bluetooth status message	58
Disconnected, iPod controlling status message	58
Display settings	50
DOCK indicator, Front panel display	20
DSP LEVEL	35
DSP level	35
DTS decoder prioritize setting	49
DVD Live Viewing	26
DVD Movie Viewing	26
DVD Viewing	26
DVR Viewing	26
Dynamic range	47

■ E

E)BLUETOOTH	50
E)LFE LEVEL	47
E)MULTI CH SET	49
Editing sound fields parameters	35
ENHANCER indicator	20
Enjoying 2-channel sources using the standard decoders	35
Exchanging preset stations	39

■ F

F)D.RANGE	47
FM tuning	37
FRONT	45
FRONT B	45
FRONT B speaker setting	45
Front panel display	20
Front speakers	45

■ G

G)AUDIO SET	48
Game	34
Game Playing	26

■ H

Hall	34
HDMI	14
HDMI jack, HDMI cable plug	14
Headphone dynamic range	47
Headphone LFE	47
Headphones indicator	20
HP D.R	47
HP LFE	47

■ I

Infrared window	21
INI.VOL.	48
Initial volume	48
Initializing	54
Input assignment	48
Input channel and speaker indicators	20
Input channel indicators	20
Input menu	43
Input rename	49

- Input source indicators 20
 Input source information 32
 Installing batteries in the
 remote control 3
 iPod connected,
 iPod controlling status message 58
 iPod control, Status message 58
- **J**
 Jazz 34
- **L**
 LFE indicator 20
 LFE/Bass out 46
 Listening to unprocessed
 input signals 36
 Low-frequency effect level 47
- **M**
 Manual preset tuning 38
 MANUAL SETUP 43
 Manual setup 43
 Manual tuning 37
 MAX VOL. 48
 Maximum volume 48
 MEM.GUARD 50
 Memory guard 50
 Movie Dramatic 34
 Movie Spacious 34
 MULTI CH INPUT jacks 9
 Multi channel input setup 49
 Multi-channel sources and sound field
 programs with headphones 36
 Multi-information display 20
 Music Disc Listening 26
 Music Enh. 2ch 34
 Music Enh. 5ch 34
 MUTE indicator 20
 MUTE TYP. 48
 Mute type 48
- **N**
 NIGHT indicator 20
 Night listening mode 31
 No BT adapter,
 Bluetooth status message 58
- **O**
 Option menu 44
- **P**
 Pairing, Bluetooth control 41
 PANORAMA 35
 Panorama 35
 Parameter initialization 50
 PCM indicator 20
 Placing speakers 10
 Playing video sources in the
 background 33
 Pop/Rock 34
 PRESET 54
 Preset SCENE templates 26
- **R**
 Radio Listening 26
- Rear panel 9
 Remote control codes iii
 Resetting the system 59
- **S**
 SCENE 7
 Searching...,
 Bluetooth status message 58
 Selecting audio input jacks 31
 Selecting preset stations 39
 Selecting the MULTI CH INPUT
 component as the input source 30
 Selecting the night listening mode 31
 Selecting the SCENE templates 24
 Set menu 43
 Set this unit to the standby mode 19
 Setting input source of the customized SCENE
 template on the remote control 28
 Setting remote control codes 53
 Setting the speaker impedance 12
 SIGNAL INFO 44
 Signal information 44
 SILENT CINEMA 36
 SILENT CINEMA indicator 20
 SLEEP indicator 20
 Sleep timer 33
 Sound field programs 34
 Sound menu 43
 SP A B indicators 20
 SP D.R 47
 SP IMP. 54
 SP LFE 47
 Speaker distance 47
 Speaker distances 47
 Speaker dynamic range 47
 Speaker impedance 54
 Speaker level 46
 Speaker LFE 47
 Speaker settings 45
 SPEAKERS terminals 9
 Specifications 62
 START PAIRING 50
 Start pairing, 50
 Straight mode 36
 SUBWOOFER OUTPUT jack 9
 Subwoofer phase 46
 Supplied accessories 3
 SUR. LR 45
 Surround left/right speakers 45
 SWFR PHASE 46
- **T**
 TEST 47
 Test tone 47
 Troubleshooting 55
 TU 54
 Tuner frequency step 54
 Tuner indicators 20
 Turning off the power 19
 Turning on the power 19
 TV Sports 34
 TV Sports Viewing 26
 TV Viewing 26
- **U**
 UNIT 47
 Unit 47
 Unknown iPod,
 iPod controlling status message 58
 Using the remote control 21
 Using your headphones 30
- **V**
 Video cable plugs 13
 VIDEO jacks 9, 13
 Video jacks 13
 Virtual CINEMA DSP 36
 VIRTUAL indicator 20
 VOLTAGE SELECTOR 3
 VOLUME level indicator 20
 Volume Trim 49
- **Z**
 Zone B 30

“(A)STANDBY/ON” or “(3)DVD”
 (example) indicates the name of the
 parts on the front panel or the remote
 control. Refer to the attached sheet
 or the pages at the end of this manual
 for the information about each
 position of the parts.

■ Front panel

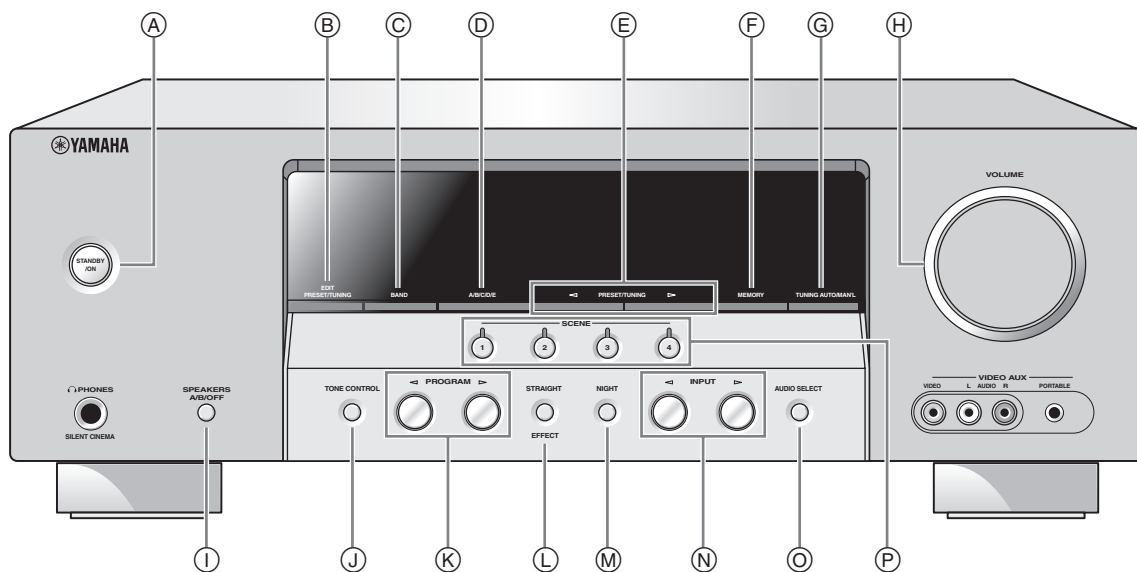

■ Remote control

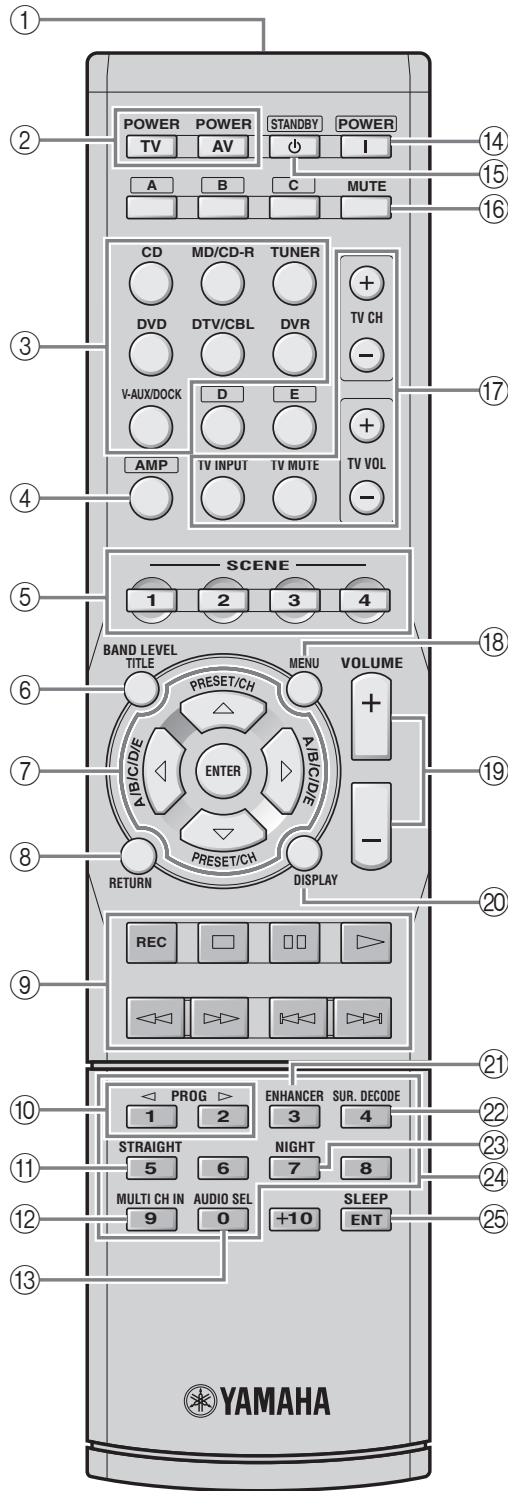

List of remote control codes

Blu-ray player		MBO	2078	Yamaha	2000, 2001, 2003, 2030, 2101	Microsoft	2132
Samsung	2137	Medion	2072	Yukai	2078	Mind	2132
CD player		Micromaxx	2072	Zenith	2038, 2047, 2073	Niveus Media	2132
Yamaha	5000, 5013	Micromedia	2073	DVD Recorder			
CD Recorder		Microstar	2072	Apex	2024	Philips	2117, 2121, 2123, 2128
Yamaha	5001	Mitsubishi	2035	JVC	2070	Pioneer	2012, 2013, 2014
DVD		Mizuda	2075	LG	2071	Proscan	2129
Acoustic Solutions		Mustek	2078	Panasonic	2020, 2065, 2066, 2067	RCA	2116, 2124, 2129, 2133
	2078	Naiko	2077	Philips	2019, 2061, 2062, 2063	ReplayTV	2118, 2119, 2120
Aiwa	2055, 2100	Onkyo	2073, 2135	Pioneer	2021	Sharp	2009, 2010
Akai	2096	Orava	2075	RCA	2018	Sonic Blue	2119, 2120
Akura	2076	P&B	2075	Sony	2022, 2064	Sony	2005, 2006, 2007, 2122, 2130, 2131, 2132
Alba	2078, 2086	Pacific	2074	Toshiba	2068	Stack 10	2132
Apex	2027, 2049	Panasonic	2030, 2040, 2054, 2057, 2105, 2110	Yamaha	2023	Stack 9	2132
Awa	2078	Philips	2019, 2026, 2046, 2073, 2081, 2090	Yukai	2069	Systemax	2132
Axion	2078	Pioneer	2036, 2082	DVD/LD			
Brainwave	2096	Proline	2077	Pioneer	2036	Tagar Systems	2132
Brandt	2073, 2085	Provision	2075	DVD/VCR			
Broksonic	2060	RCA	2031, 2042, 2050, 2051	JVC	1017, 2045	Tivo	2116, 2121, 2122, 2123, 2130, 2131
Bush	2075, 2078, 2112	Red Star	2076	LG	1071, 2087	Toshiba	2004, 2125, 2132
Centrex	2077	Reoc	2074	Panasonic	1020, 1072, 2040, 2105	Touch	2132
Classic	2078	Roadstar	2075, 2078, 2086	Philips	1025	UltimateTV	2133
Clatronic	2075	Rowa	2077	RCA	1022, 2042	Viewsonic	2132
Coby	2078	Saba	2085	Samsung	1021, 2041, 2104	Voodoo	2132
C-Tech	2074	Sabaki	2074	Sharp	1023, 1073, 2043, 2106	Yamaha	2011
CyberHome	2025, 2079, 2091	Samsung	2032, 2041, 2104, 2113	Sony	1019, 1074, 2039, 2107	ZT Group	2132
Daewoo	2092, 2098	Sansui	2074	HD DVD			
Dansai	2096	Sanyo	2095	Toshiba	1024, 1075, 2044, 2108	Toshiba	2136
Daytek	2080, 2089	ScanMagic	2078	Zenith	1026, 2047	iPod	
DEC	2075	Scientific Labs	2074	DVD-DVR			
Denon	2030, 2102, 2103	Scott	2088	Panasonic	2067	Yamaha	5011
Denver	2075, 2076	SEG	2074, 2086	Pioneer	2114	LD player	
Diamond	2074	Sharp	2034, 2043, 2059, 2093, 2106	Samsung	2115	Yamaha	5002, 5003, 5004
DK Digital	2094	Silva	2076	Toshiba	2068	TAPE DECK	
Dual	2078	Singer	2074	DVR			
D-Vision	2096	Skymaster	2074, 2078	ABS	2132	Yamaha	5005, 5006
DVX	2074	Skyworth	2076	Alienware	2132	TUNER	
Elta	2096	SM Electronic	2074, 2078	CyberPower	2132	Yamaha	5007, 5008, 5009, 5010, 5012, 5014, 5015, 5016, 5017, 5018
Euroline	2096	Sony	2028, 2029, 2039, 2083, 2107	Dell	2132	TV	
Funai	2052, 2058	Soundmaster	2074	DIRECTV	2123, 2128, 2129, 2133	Acer	0093
Global Solutions	2074	Soundmax	2074	DISH Network	2126, 2127	Acme	0207
Global Sphere	2074	Standard	2074	Dishpro	2126	Acura	0208
Goodmans	2075, 2077, 2078	Star Cluster	2074	Echostar	2126, 2127	ADA	0255
Grundig	2077, 2098	Starmedia	2075	Expressvu	2126	ADC	0206
H&B	2075	Supervision	2074, 2078	Gateway	2132	Admiral	0058, 0205, 0206, 0210, 0211
Haaz	2074	Sylvania	2052, 2058	GOI	2126	Adyson	0200, 0207
HE	2078	Synn	2074	Hewlett Packard	2132	Agashi	0200
Hitachi	2032, 2072	TCM	2072	Hitachi	2008	Agazi	0206
Home Electronics	2078	Teac	2074	Howard Computers	2132	AGB	0204
Innovation	2072	Tec	2076	HTS	2126	Aiko	0127, 0200, 0207, 0208
Irradio	2134	Technics	2030	Hughes	2123, 2128	Aiwa	0028, 0139, 0229, 0237
JDB	2078	Technika	2096	Humax	2123		
JVC	2033, 2045, 2053, 2073, 2099	Technosonic	2096	Hush	2132		
Kenwood	2030, 2097	Tevion	2072, 2074	iBUYPOWER	2132		
Kingavon	2075	Thomson	2085, 2109	JVC	2126, 2127		
Koda	2075	Tokai	2076	Linksys	2132		
Lawson	2074	Toshiba	2026, 2044, 2048, 2056, 2073, 2108, 2111	Media Center PC	2132		
Lenco	2075	United	2078				
LG	2084, 2087	Voxson	2078				
Lifetec	2072	Wharfedale	2074				
Limit	2074	Xlogic	2074				
LogicLab	2074	Yakumo	2077				
Luxor	2077	Yamada	2077				
Magnavox	2037, 2073, 2075						
Magnum	2072						

Akai	0059, 0065, 0127, 0129, 0130, 0200, 0204, 0208, 0209, 0213, 0217, 0218, 0255	Cascade	0208	Envision	0060, 0061	Hisawa	0209, 0218
		Cathay	0213, 0217	Erres	0213, 0217	Hitachi	0006, 0014, 0015, 0016, 0042, 0060, 0061, 0095, 0105, 0127, 0156, 0179, 0180, 0204, 0207, 0210, 0211, 0215, 0216, 0251
		CCE	0127	ESA	0080		
		Celebrity	0059	Etron	0208		
Akiba	0209, 0218	Centurion	0213, 0217	Euro-Feel	0206		
Akura	0206, 0209, 0218	Century	0205	Euroline	0217		
Alaron	0200	CGE	0214, 0215	Euroman	0200		
Alba	0200, 0207, 0208, 0209, 0217, 0218	Cimline	0208, 0218	Euromann	0206, 0207, 0213		
ALBIRAL	0212	Citizen	0060, 0061, 0062, 0064	Europhon	0200, 0204, 0207, 0213, 0215	Hornlyphon	0213
Allstar	0213	City	0208	Fenner	0208	Hoshai	0209, 0218
Amplivision	0207	Clarivox	0212, 0217	Ferguson	0212, 0217, 0226	Huanyu	0200, 0207
Amstrad	0204, 0206, 0208, 0209, 0218	Clatronic	0206, 0207, 0208, 0209, 0213, 0214, 0218	Fidelity	0200, 0207, 0210	Hygashi	0200, 0207
				Finlandia	0210	Hyper	0200, 0207, 0208, 0214, 0215
Amtron	0062	CMS	0200	Finlux	0204, 0205, 0207, 0213, 0215, 0217	Hypson	0206, 0207, 0213, 0217
Anam	0208	Colortyme	0060, 0061	Firstline	0200, 0207, 0208, 0213, 0214	ICE	0127, 0200, 0206, 0207, 0208, 0209, 0213, 0218
Anam National	0062	Concerto	0060, 0061	Fisher	0064, 0127, 0128, 0205, 0207, 0215	ICeS	0200, 0218
Anglo	0208	Concorde	0208	Flint	0213, 0218	IMA	0062
Anitech	0206, 0208	Condor	0200, 0207, 0213	Formenti	0200, 0205, 0207, 0215, 0217	Imperial	0211, 0213, 0214, 0215
Ansonic	0203, 0208	Contec	0200, 0207, 0208	Formenti-Phoenix	0200	Indiana	0213, 0217
AOC	0060, 0061	Contec/Cony	0062	Fortress	0205	Infinity	0063
Apex	0118, 0122, 0132	Continental Edison	0216	Frontech	0206, 0208, 0210, 0211, 0214	Ingelen	0211
Arc en Ciel	0216	Cosmel	0208	Fujitsu	0023, 0024, 0025, 0088, 0127	Inno Hit	0201, 0204, 0207, 0208, 0209, 0213, 0217, 0218
Arcam	0200	Craig	0062	Funai	0033, 0034, 0035, 0036, 0037, 0062, 0206	Innovation	0206, 0208
Arcam Delta	0207	Crosley	0205, 0214, 0215	Futurtech	0062	Interbuy	0208, 0214
Aristona	0213, 0217	Crown	0062, 0063, 0128, 0208, 0213, 0217	Gateway	0094	Interfunk	0205, 0211, 0213, 0214, 0216, 0217
ASA	0205, 0211	CS Electronics	0200, 0207, 0209, 0214, 0218	GBC	0208, 0215, 0218	International	0200
Asberg	0213	CTC	0214	GE	0057, 0060, 0061, 0122, 0147	Intervision	0206, 0207, 0218
Astra	0208	Curtis Mathes	0057, 0060, 0061, 0064, 0065	GEC	0204, 0207, 0211, 0213, 0217	Irradio	0201, 0208, 0209, 0213, 0217, 0218
Asuka	0200, 0206, 0207, 0209, 0218	CXC	0062	Geloso	0208, 0210, 0215	Isukai	0209, 0218
Atlantic	0200, 0207, 0213, 0217	Cybertron	0209, 0218	General Technic	0208	ITC	0207, 0215
Atori	0208	Daewoo	0060, 0061, 0120, 0127, 0155, 0193, 0200, 0207, 0208, 0213, 0218, 0238	Genexxa	0209, 0211, 0213, 0218	ITS	0200, 0209, 0213, 0218
Audiosonic	0207, 0208, 0209, 0213, 0216, 0217, 0218	Dainichi	0200, 0209, 0218	Gibraltar	0060	ITT	0129, 0208, 0211
		Dansai	0200, 0206, 0213, 0217	GoldHand	0200	ITV	0208, 0217
AudioTon	0207	Dantax	0217	GoldStar	0060, 0061, 0127, 0128, 0200, 0201, 0207, 0208, 0210, 0213, 0214, 0215, 0217	JBL	0063
Audiovox	0062	Daytron	0060, 0061, 0208			JC Penney	0057, 0060, 0061
Autovox	0205, 0206, 0207	De Graaf	0210			JCB	0059
Awa	0200	Decca	0204, 0207, 0213, 0217			Jensen	0060, 0061
Baird	0216	Desmet	0213, 0217			JVC	0017, 0018, 0019, 0108, 0136, 0153, 0178, 0190, 0213, 0218
Bang & Olufsen	0205	Diamond	0200	Goodmans	0171, 0201, 0204, 0206, 0208, 0213, 0217, 0240	Kaisui	0200, 0207, 0208, 0209, 0218
Basic Line	0208, 0209, 0213, 0218	Dimensia	0057	GPM	0209, 0218	Kamosonic	0207
		Dixi	0208, 0213, 0217	Graetz	0211	Kamp	0200, 0207
Bastide	0207	DTS	0208	Granada	0204, 0207, 0210, 0213, 0217	Kapsch	0211
Baur	0217	Dual	0207, 0215, 0216			Karcher	0207, 0208, 0212, 0217
Beko	0228	Dual-Tec	0207, 0208, 0215	Grandin	0208, 0209, 0217	Kawasho	0059, 0060, 0061, 0200
Belcor	0060	Dumont	0060, 0127, 0205, 0207	Grundig	0128, 0130, 0222, 0236, 0255	Kendo	0128, 0210
Bell & Howell	0058, 0064	Durabrand	0126	Grunpy	0062	Kennedy	0215
Benq	0081	Dux	0217	Halifax	0200, 0206, 0207	Kenwood	0060, 0061
Beon	0213, 0217	Dynatron	0213, 0217	Hallmark	0060, 0061	Kingsley	0200, 0207
Bestar	0213	Elbe	0203, 0204, 0212, 0218	Hampton	0200, 0207	Kloss Novabeam	
Binatone	0207	Elbe-Sharp	0204	Hanseatic	0203, 0207, 0208, 0213, 0215, 0217		
Black Star	0214	Elcit	0204, 0205	Hantarex	0204, 0208		
Blaupunkt	0255	ELECTRO TECH	0208	Harvard	0062		
Blue Sky	0209, 0218	Electroband	0059	HCM	0206, 0207, 0208, 0218		
Bondstec	0214	Electrohome	0059, 0060, 0061	Hifivox	0216		
Boots	0207	Elin	0200, 0207, 0213, 0217	Higashi	0200		
Bradford	0062	Elite	0209, 0213, 0218	Hinari	0208, 0209, 0213, 0217, 0218		
Brandt	0216, 0226	Elman	0215				
Brionvega	0205, 0213, 0217	Elta	0200, 0208				
Britannia	0200, 0207	Elta	0200, 0208				
Brockwood	0060	Emerson	0060, 0061, 0062, 0064, 0128, 0205				
Broksomic	0138						
Bruns	0205						
BSR	0215						
BTC	0209, 0218						
Bush	0177, 0208, 0209, 0210, 0213, 0215, 0216, 0217, 0218, 0230, 0237						
Candle	0060, 0061						
Capsonic	0206						

Lenco	0208	NEC	0026, 0053, 0060,	0182, 0194, 0195,	Sanyo	0020, 0021, 0022,
Lenoir	0207, 0208		0061, 0096, 0127	0211, 0213, 0216,		0049, 0060, 0064,
Lesla	0214	Neckermann	0205, 0207, 0210,	0217, 0250		0127, 0128, 0200,
Leyco	0206, 0213, 0217		0213, 0217, 0255	0206, 0213		0203, 0207, 0215
LG	0016, 0038, 0039,	NEI	0213, 0217	Polaroid	SBR	0217
	0127, 0128, 0157,	Nesco	0214	Poppy	SCHAUB LORENTZ	
	0158, 0163, 0164,	NET-TV	0082, 0101	Portland		0211
	0166, 0188, 0189,	New Tech	0208, 0213	Prandoni-Prince	Schneider	0207, 0209, 0213,
	0200, 0201, 0207,	New World	0209, 0218	Precision		0215, 0216, 0217,
	0208, 0210, 0213,	Nicamagic	0200, 0207	Prima		0218
	0214, 0215, 0217	Nikkai	0200, 0206, 0207,	Profex	Scotch	0061
Liesenk	0217		0209, 0213, 0217,	Profi-Tronic	Scott	0060, 0061, 0062
Life	0206, 0208		0218	Proline	Sears	0057, 0060, 0061,
Lifetec	0206, 0208, 0218	Nikko	0061	Proscan		0064
Loewe	0063, 0128, 0203,	Nobliko	0200, 0207	Prosonic	SEG	0200, 0206, 0207,
	0204, 0223, 0227	Nogamatic	0216	Protech		0214, 0215, 0217
Loewe Opta	0205, 0213, 0217	Nokia	0129, 0211		SEI	0204
Logik	0058	Nordmende	0205, 0211, 0213,		SEI-Sinudyne	0204, 0205, 0211
Luma	0210, 0217		0216	Proton	Seleco	0210, 0211, 0215
Lumatron	0210, 0213, 0217	Nordvision	0217	Provision	Sencora	0208
Lux May	0213	Oceanic	0211	Pulsar	Sentra	0218
Luxman	0060, 0061	Olevia	0084	Pye	Serino	0200
Luxor	0201, 0207, 0210	ONCEAS	0207	Pymi	Sharp	0009, 0010, 0011,
LXI	0057, 0061, 0063,	Onwa	0062, 0218	Quasar		0060, 0061, 0066,
	0064	Orbit	0213	Quelle		0070, 0087, 0111,
Magnadyne	0204, 0205, 0214,	Orion	0126, 0204, 0208,			0143, 0145, 0167,
	0215, 0217		0213, 0217, 0235			0168, 0169, 0198,
Magnafon	0200, 0204, 0207	Orline	0218	Radialva		0204, 0224, 0247,
Magnavox	0060, 0061, 0063,	Orsowe	0204	Radio Shack		0248, 0249
	0102, 0103, 0150	Osaki	0127, 0206, 0207,	Radio Shack/Realistic	Shogun	0060
Magnum	0206, 0208		0209, 0218		Siarem	0204, 0205, 0215
Majestic	0058	Osio	0201		Sicatel	0212
Mandor	0206	Oso	0209, 0218	Radiola	Siemens	0255
Manesth	0206, 0207, 0213,	Osume	0218	Radiomarelli	Sierra	0213
	0217	Otto Versand	0204, 0207, 0213,	Radiotone	Signature	0058
Marantz	0060, 0061, 0063,		0215, 0216, 0217,	RCA	Silva	0200
	0090, 0213, 0217		0255		Singer	0205, 0214, 0215
Marelli	0205	Pael	0200, 0207		Sinudyne	0204, 0205, 0215,
Mark	0200, 0213, 0217	Palladium	0207	Realistic		0217
Matsui	0204, 0207, 0208,	Panama	0200, 0206, 0207,	Revox	Skantic	0211
	0210, 0213, 0217		0208	Rex	Solavox	0211
Mediator	0213, 0217	Panasonic	0006, 0007, 0063,	RFT	Sonoko	0206, 0207, 0208,
Medion	0206, 0208		0073, 0074, 0097,	Rhapsody		0213, 0217
Megatron	0061		0110, 0114, 0137,	R-Line	Sonolor	0211
Melectronic	0200, 0207, 0208,		0141, 0151, 0162,	Roadstar	Sontec	0213, 0217
	0211, 0213, 0216,		0165, 0186, 0204,		Sony	0041, 0059, 0067,
	0217		0211, 0244, 0245,	Robotron		0085, 0086, 0174,
Memorex	0058, 0061, 0064,		0246, 0254	Rowa		0196, 0199, 0208,
	0208	Pathe Cinema	0200, 0203, 0207,	RTF		0219, 0234
Memphis	0208		0212, 0215	Saba	Sound & Vision	0209, 0218
Metz	0205	Pathe Marconi	0212, 0216		Soundesign	0060, 0061, 0062
MGA	0060, 0061	Pausa	0208	saccs	Soundwave	0213, 0217
Micromaxx	0206, 0208	Perdio	0200	Saisho	SSS	0060, 0062
Microstar	0206, 0208	Philco	0060, 0061, 0063,		Standard	0207, 0208, 0209,
Minerva	0204		0128, 0205, 0214,	Salora		0213, 0218
Minoka	0213		0215		Starlight	0217
Mitsubishi	0006, 0015, 0016,	Philharmonic	0207	Sambers	Starlite	0062
	0048, 0060, 0061,	Philips	0040, 0060, 0063,	Sampo	Stenway	0218
	0104, 0112, 0113,		0072, 0115, 0116,		Stern	0210, 0211
	0125, 0205, 0213		0124, 0130, 0150,	Samsung	Sunkai	0208, 0218
Mivar	0200, 0201, 0202,		0175, 0184, 0187,		Sunwood	0208, 0213
	0203, 0204, 0207		0205, 0207, 0213,		Superla	0200, 0204, 0207
Montgomery Ward			0215, 0217, 0220,		SuperTech	0200
	0058		0221, 0232, 0233,		Supra	0208
MTC	0060, 0061, 0128,		0252, 0253		Supreme	0059
	0200	Philips Magnavox			Susumu	0209
Multi System	0217		0124		Sutron	0208
Multitech	0062, 0127, 0128,	Phoenix	0200, 0205, 0213,		Sydney	0200, 0207
	0200, 0207, 0208,		0217		Sylvania	0060, 0061, 0063,
	0210, 0214, 0215,	Phonola	0200, 0205, 0213,			0080, 0134, 0142,
	0217		0217			0148
Murphy	0200, 0207	Pilot	0060		Symphonic	0062, 0080
NAD	0061	Pioneer	0012, 0013, 0060,	Sandra	Sysline	0217
Naonis	0210		0061, 0098, 0109,	Sansui	Sytong	0200
			0117, 0128, 0181,			

Tandy	0127, 0207, 0209, 0211, 0218	Weltblick	0213, 0217	Alba	1044, 1050	GoldHand	1050
Tashiko	0200, 0207, 0210	Weston	0215	American High	1004	Goldstar	1000, 1003, 1042, 1045
Tatung	0127, 0204, 0207, 0213, 0217, 0237	White Westinghouse	0200, 0207, 0217	Amstrad	1042	Goodmans	1042, 1045, 1050, 1069
TCM	0206, 0208	Yamaha	0000, 0001, 0002, 0003, 0004, 0005, 0060, 0061	Anitech	1050	Gradiente	1005
Teac	0127			ASA	1045, 1046	Graetz	1043, 1047
Tec	0207, 0208, 0214, 0215	Yamishi	0218	Asha	1002, 1014	Granada	1046, 1047, 1049
Techwood	0060, 0061	Yoko	0200, 0206, 0207, 0208, 0209, 0213, 0217, 0218	Asuka	1042, 1045, 1046, 1050	Grandin	1042, 1045, 1050
Teknika	0058, 0060, 0061, 0062			Audio Dynamics	1000	Grundig	1046, 1050, 1062
Teleavia	0216	Yorx	0209, 0218	Baird	1042, 1043, 1047	Hanseatic	1045, 1046
Telecor	0218	Zanussi	0210	Basic Line	1044, 1050	Harley Davidson	1005
Telefunken	0065, 0213, 0216	Zenith	0058, 0060, 0100, 0105, 0119, 0121, 0154	Baur	1046	Harman/Kardon	1000
Telegazi	0218			Beaumont	1002, 1014	Harwood	1006
Teletech	0208, 0214, 0217			Bell & Howell	1001	HCM	1050
Teleton	0207			Blaupunkt	1046, 1048	Headquarter	1001
Televideon	0200			Brokronic	1012, 1013	Hinarik	1044, 1050
Tensai	0208, 0209, 0213, 0218			Bush	1044, 1050, 1066	Hisawa	1044
Tesmet	0213			Calix	1003	Hitachi	1007, 1010, 1039, 1042, 1043, 1046, 1049
Tevion	0206, 0208			Candle	1002, 1003	Hughes Network Systems	1010
Textet	0200, 0207			Canon	1004	Hypson	1044, 1050
Thomson	0191, 0192, 0207, 0213, 0216, 0226			CCE	1006	Imperial	1042
Thorn	0212, 0217			CGE	1042, 1043	Inno Hit	1046, 1050
TMK	0060, 0061			Cimline	1044, 1050	Innovation	1044, 1048
Tokai	0213			Citizen	1002, 1003	Instant Replay	1004
Tokyo	0200, 0207			Colortyme	1000	Interbuy	1045
Toshiba	0027, 0043, 0053, 0054, 0064, 0078, 0089, 0090, 0106, 0107, 0127, 0131, 0140, 0146, 0159, 0197, 0225, 0231, 0237			Colt	1006	Interfunk	1046, 1047
	0211, 0215			Craig	1002, 1003, 1006, 1014	Intervision	1042
Transtec	0200			Crown	1050	Irradio	1045, 1050
Trident	0204			Curtis Mathes	1000, 1002, 1004, 1009	ITT	1043, 1047
Tristar	0218			Cybernex	1002, 1014	ITV	1045
Triumph	0204			Daewoo	1005, 1038, 1061, 1067	JC Penney	1000, 1001, 1002, 1003, 1004, 1006
Uher	0211, 0213			Dansai	1050	JCL	1004
Ultravox	0200, 0205, 0207, 0214, 0215			Dantax	1044	Jensen	1007
United	0217			DBX	1000	JVC	1000, 1001, 1007, 1011, 1017, 1036, 1043
Universum	0127, 0128, 0129, 0201, 0206, 0213, 0214, 0215, 0217			De Graaf	1046, 1049	Kaisui	1050
Univox	0212			Decca	1042, 1043, 1046	Karcher	1046
Vestel	0210, 0211, 0213, 0214, 0215, 0217			Denon	1010	Kendo	1044
Vexa	0208, 0217			Dimensia	1009	Kenwood	1000, 1001, 1007, 1011, 1043
Victor	0213			Dual	1043, 1046	KLH	1006
VIDEOLOGIC	0200			Dumont	1042, 1046, 1047, 1049	Kodak	1003, 1004
Videologique	0200, 0207, 0209, 0218			Dynatech	1005	Korpel	1050
Videosat	0214			Electrohome	1003	Leyco	1050
VideoSystem	0213			Electrographic	1003	LG	1003, 1042, 1045, 1071
Videotechnic	0200			Elta	1050	Lifetec	1044, 1048
Vidtech	0060, 0061			Emerson	1003, 1004, 1005, 1012, 1013	Lloyd's	1005
Viewsonic	0076, 0077, 0092, 0099, 0172, 0173			Etzuko	1050	Loewe	1048
Visiola	0200, 0207			Ferguson	1043	Loewe Opta	1045, 1046
Vision	0213			Fidelity	1042	Logik	1006, 1050
Vortec	0213, 0217			Finlandia	1046, 1047, 1049	Luxor	1047
Voxson	0205, 0210, 0211, 0213			Finlux	1042, 1043, 1046, 1047, 1049	LXI	1003
Waltham	0207, 0212			FIRST LINE	1044, 1045, 1049, 1050	M Electronic	1042
Wards	0057, 0058, 0060, 0061, 0063			Fisher	1001, 1047	Magnasonic	1047
Watson	0213, 0217, 0218			Flint	1044	Magnavox	1004, 1018, 1033
Watt Radio	0200, 0207, 0212, 0215			Formenti/Phoenix	1046	Magnin	1003, 1014
Wega	0205			Fuji	1004	Manesth	1050
				Fujitsu	1042	Marantz	1000, 1001, 1004, 1046, 1051
				Funai	1005, 1042	Marta	1003
				Galaxy	1042	Matsui	1044, 1045
				Garrard	1005	Matsushita	1004
				GBC	1050	Mediator	1046
				GE	1002, 1004, 1009, 1014, 1030	Medion	1044, 1048
				GEC	1046	MEI	1004
				Geloso	1050		
				General Technic	1044, 1048		
				Go Video	1014		

TV/DVD

Aiwa	0139, 2055
Apex	0132, 2049
Brokronic	0138, 2060
Bush	0230, 2112
JVC	0136, 2053
Panasonic	0137, 0254, 2054, 2110
RCA	0133, 0135, 2050, 2051
Sylvania	0134, 2052
Thomson	0226, 2109
Toshiba	0131, 0231, 2048, 2111

TV/DVD/VCR

Panasonic	0141, 1040, 2057
Samsung	0241, 1070, 2113
Sharp	0143, 1028, 2059
Sylvania	0142, 1041, 2058
Toshiba	0140, 1029, 2056

TV/VCR

Aiwa	0237, 1066
Bush	0237, 1066
Daewoo	0155, 0238, 1038, 1067
GE	0147, 1030
Goodmans	0240, 1069
Grundig	0236, 1062
Hitachi	0156, 1039
JVC	0153, 1036
Magnavox	0150, 1033
Orion	0235, 1065
Panasonic	0151, 1034
Philips	0150, 0232, 0233, 1033, 1062, 1063
Quasar	0152, 1035
RCA	0149, 1032
Roadstar	0237, 1066
Samsung	0144, 0239, 1027, 1068
Sharp	0145, 1028
Sony	0234, 1064
Sylvania	0148, 1031
Tatung	0237, 1066
Toshiba	0146, 0237, 1029, 1066
Zenith	0154, 1037

VCR

Admiral	1008, 1013
Adventura	1005
Aiwa	1005, 1042, 1043, 1044, 1066
Akai	1007, 1043
Akiba	1050
Akura	1043, 1050

Memorex	1001, 1002, 1003, 1004, 1005, 1008, 1013, 1014, 1042, 1045, 1047	Pathe Marconi	1043	Samsung	1002, 1014, 1021, 1027, 1052, 1068, 1070	Tatung	1007, 1042, 1043, 1046, 1066
Memphis	1050	Penney	1010, 1014	Sanky	1008	TCM	1044, 1048
Metz	1048	Pentax	1010, 1049	Sansui	1007, 1011, 1013, 1043	Teac	1005, 1007
MGA	1014	Perdio	1042	Sanyo	1001, 1002, 1014, 1047	Technics	1004, 1048
MGN Technology		Philco	1004, 1051	SBR	1046	Teknika	1003, 1004, 1005
	1002, 1014	Philips	1004, 1025, 1033, 1046, 1056, 1057, 1059, 1062, 1063	Schaub Lorenz	1042, 1043, 1047	Teleavia	1043
Micromaxx	1044, 1048	Philips Magnavox		Schneider	1042, 1044, 1045, 1046, 1050	Telefunken	1043
Microstar	1044, 1048		1018	Scott	1012	Tenosal	1050
Migros	1042	Phonola	1046	Sears	1001, 1003, 1004, 1010	Tensai	1042, 1045, 1050
Minolta	1010	Pilot	1003	SEG	1050	Tevion	1044, 1048
Mitsubishi	1011, 1042, 1046	Pioneer	1011, 1046	SEI-Sinudyne	1046	Thomson	1043, 1058
Montgomery Ward		Prinz	1042	Seleco	1043	Thorn	1043, 1047
	1008	Profex	1050	Sentron	1050	TMK	1002, 1014
Motorola	1004, 1008	Profitronic	1014	Sharp	1008, 1023, 1028, 1053, 1073	Tokai	1045, 1050
MTC	1002, 1014	Proline	1042	Shintom	1006, 1047, 1050	Tonsai	1050
Multitech	1002, 1005, 1006, 1042, 1046, 1050	Proscan	1009	Shivaki	1045	Toshiba	1013, 1024, 1029, 1043, 1046, 1066, 1075
Murphy	1042	Prosonic	1044	Shogun	1002, 1014	Totevision	1002, 1003, 1014
National	1048	Protex	1006	Siemens	1045, 1047	Towada	1050
NEC	1000, 1001, 1007, 1011, 1043, 1051	Pye	1046, 1056	Signature 2000	1008	Towika	1050
Neckermann	1043, 1046	Quarter	1001	Silva	1045	Uher	1045
NEI	1046	Quartz	1001, 1047	Singer	1004, 1006	Unitech	1002, 1014
Nesco	1050	Quasar	1004, 1035	Sinudyne	1046	Universum	1042, 1045, 1046
Nikko	1003	Quelle	1042, 1046, 1047	Sontec	1045	Vector Research	1000
Noblex	1002, 1014	Radio Shack	1003	Sony	1016, 1019, 1055, 1060, 1064, 1074	Video Concepts	1000
Nokia	1043, 1047	Radio Shack/Realistic		STS	1004, 1010	Videon	1044, 1048
Nordmende	1043		1001, 1002, 1003, 1004, 1005, 1008	Sunkai	1044	Videosonic	1002, 1014
Oceanic	1042, 1043	Radiola	1046	Sunstar	1042	Wards	1002, 1003, 1004, 1005, 1006, 1008, 1010, 1014
Okano	1044	Radix	1003	Suntronic	1042	Weltblick	1045
Olympus	1004	Randex	1003	Sunwood	1050	White Westinghouse	
Optimus	1003, 1008	RCA	1002, 1004, 1009, 1010, 1014, 1015, 1022, 1032	Sylvania	1004, 1005, 1031, 1041	XR-1000	1004, 1005, 1006
Orion	1012, 1013, 1044, 1065	Realistic	1001, 1002, 1003, 1004, 1005, 1008	Symphonic	1005	Yamaha	1000, 1001, 1007
Orson	1042	Rex	1043	Taisho	1044	Yamishi	1050
Osaki	1042, 1045, 1050	RFT	1046	Tandy	1001	Yokan	1050
Otto Versand	1046	Roadstar	1045, 1050, 1066	Tashiko	1003, 1042	Yoko	1045, 1050
Palladium	1043, 1045, 1050	Saba	1043			Zenith	1013, 1026, 1037
Panasonic	1004, 1020, 1034, 1040, 1048, 1054, 1072	Saisho	1044, 1050				
		Salora	1047				



© 2008 YAMAHA CORPORATION All rights reserved.

YAMAHA ELECTRONICS CORPORATION, USA 6660 ORANGETHORPE AVE., BUENA PARK, CALIF. 90620, U.S.A.
 YAMAHA CANADA MUSIC LTD. 135 MILNER AVE., SCARBOROUGH, ONTARIO M1S 3R1, CANADA
 YAMAHA ELECTRONIK EUROPA G.m.b.H. SIEMENSSTR. 22-34, 25462 RELINGEN BEI HAMBURG, GERMANY
 YAMAHA ELECTRONIQUE FRANCE S.A. RUE AMBROISE CROIZAT BP70 CROISSY-BEAUBOURG 77312 MARNE-LA-VALLEE CEDEX02, FRANCE
 YAMAHA ELECTRONICS (UK) LTD. YAMAHA HOUSE, 200 RICKMANSWORTH ROAD WATFORD, HERTS WD18 7GQ, ENGLAND
 YAMAHA SCANDINAVIA A.B. J A WETTERGRENS GATA 1, BOX 30053, 400 43 VÄSTRA FRÖLUNDA, SWEDEN
 YAMAHA MUSIC AUSTRALIA PTY, LTD. 17-33 MARKET ST., SOUTH MELBOURNE, 3205 VIC., AUSTRALIA

YAMAHA CORPORATION
 Printed in China ◁ WQ16440

The circled numbers and alphabets correspond to those in the Owner's Manual.
 Les nombres et lettres dans un cercle correspondent à ceux du mode d'emploi.

■ Front panel/Face avant

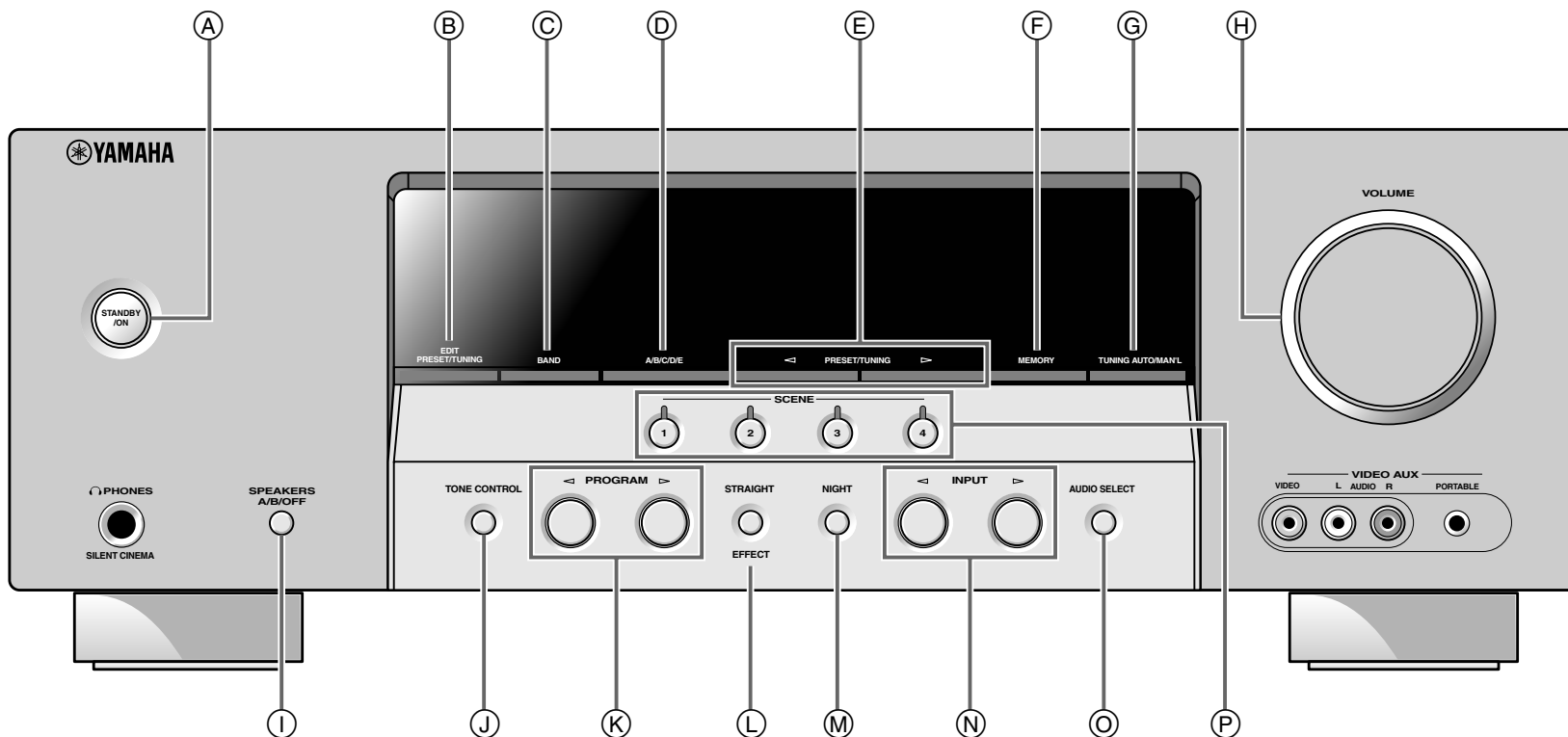

■ Remote control/Boîtier de télécommande

