



USB-MIDI INTERFACE UX96

English

Deutsch

Français

Owner's Manual
Bedienungsanleitung
Mode d'emploi

SPECIAL MESSAGE SECTION

This product utilizes an external power supply (adapter). DO NOT connect this product to any power supply or adapter other than one described in the manual, on the name plate, or specifically recommended by Yamaha.

WARNING: Do not place this product in a position where anyone could walk on, trip over, or roll anything over power or connecting cords of any kind. The use of an extension cord is not recommended! If you must use an extension cord, the minimum wire size for a 25' cord (or less) is 18 AWG. NOTE: The smaller the AWG number, the larger the current handling capacity. For longer extension cords, consult a local electrician.

This product should be used only with the components supplied or; a cart, rack, or stand that is recommended by Yamaha. If a cart, etc., is used, please observe all safety markings and instructions that accompany the accessory product.

SPECIFICATIONS SUBJECT TO CHANGE:

The information contained in this manual is believed to be correct at the time of printing. However, Yamaha reserves the right to change or modify any of the specifications without notice or obligation to update existing units.

Do not attempt to service this product beyond that described in the user-maintenance instructions. All other servicing should be referred to qualified service personnel.

This product, either alone or in combination with an amplifier and headphones or speaker/s, may be capable of producing sound levels that could cause permanent hearing loss. DO NOT operate for long periods of time at a high volume level or at a level that is uncomfortable. If you experience any hearing loss or ringing in the ears, you should consult an audiologist. **IMPORTANT:** The louder the sound, the shorter the time period before damage occurs.

Some Yamaha products may have benches and/ or accessory mounting fixtures that are either supplied with the product or as optional accessories. Some of these items are designed to be dealer assembled or installed. Please make sure that benches are stable and any optional fixtures (where applicable) are well secured BEFORE using. Benches supplied by Yamaha are designed for seating only. No other uses are recommended.

NOTICE:

Service charges incurred due to a lack of knowledge relating to how a function or effect works (when the unit is operating as designed) are not covered by the manufacturer's warranty, and are therefore the owners responsibility. Please study this manual carefully and consult your dealer before requesting service.

ENVIRONMENTAL ISSUES:

Yamaha strives to produce products that are both user safe and environmentally friendly. We sincerely believe that our products and the production methods used to produce them, meet these goals. In keeping with both the letter and the spirit of the law, we want you to be aware of the following:

Disposal Notice:

Should this product become damaged beyond repair, or for some reason its useful life is considered to be at an end, please observe all local, state, and federal regulations that relate to the disposal of products that contain lead, batteries, plastics, etc. If your dealer is unable to assist you, please contact Yamaha directly.

NAME PLATE LOCATION:

The graphic below indicates the location of the name plate for this model. The model number, serial number, power requirements, etc., are located on this plate. You should record the model number, serial number, and the date of purchase in the spaces provided below and retain this manual as a permanent record of your purchase.

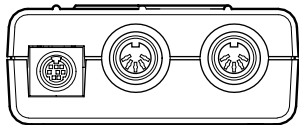

Model _____

Serial No. _____

Purchase Date _____

PLEASE KEEP THIS MANUAL

PRECAUTIONS

PLEASE READ CAREFULLY BEFORE PROCEEDING

* Please keep these precautions in a safe place for future reference.



WARNING

Always follow the basic precautions listed below to avoid the possibility of serious injury or even death from electrical shock, short-circuiting, damages, fire or other hazards. These precautions include, but are not limited to, the following:

- Do not open the instrument or attempt to disassemble the internal parts or modify them in any way. The instrument contains no user-serviceable parts. If it should appear to be malfunctioning, discontinue use immediately and have it inspected by qualified Yamaha service personnel.
- Do not expose the instrument to rain, use it near water or in damp or wet conditions, or place containers on it containing liquids which might spill into any openings.
- If the USB cable becomes frayed or damaged, or if there is a sudden loss of sound during use of the instrument, or if any unusual smells or smoke should appear to be caused by it, immediately disconnect the USB cable, and have the instrument inspected by qualified Yamaha service personnel.
- Before cleaning the instrument, always remove the USB cable. Never insert or remove a USB cable with wet hands.



CAUTION

Always follow the basic precautions listed below to avoid the possibility of physical injury to you or others, or damage to the instrument or other property. These precautions include, but are not limited to, the following:

- Do not place the USB cable near heat sources such as heaters or radiators, and do not excessively bend or otherwise damage the cable, place heavy objects on it, or place it in a position where anyone could walk on, trip over, or roll anything over it.
- Unplug the USB cable when not using the instrument, or during electrical storms.
- Before connecting the instrument to other electronic components, turn off the power for all components. Before turning the power on or off for all components, set all volume levels to minimum. Also, be sure to set the volumes of all components at their minimum levels and gradually raise the volume controls while playing the instrument to set the desired listening level.
- Do not expose the instrument to excessive dust or vibrations, or extreme cold or heat (such as in direct sunlight, near a heater, or in a car during the day) to prevent the possibility of panel disfiguration or damage to the internal components.
- Do not use the instrument near other electrical products such as televisions, radios, or speakers, since this might cause interference which can affect proper operation of the other products.
- Do not place the instrument in an unstable position where it might accidentally fall over.
- Before moving the instrument, remove all connected cables.
- When cleaning the instrument, use a soft, dry cloth. Do not use paint thinners, solvents, cleaning fluids, or chemical-impregnated wiping cloths. Also, do not place vinyl, plastic or rubber objects on the instrument, since this might discolor the panel or keyboard.
- Do not rest your weight on, or place heavy objects on the instrument, and do not use excessive force on the connectors.

Yamaha cannot be held responsible for damage caused by improper use or modifications to the instrument, or data that is lost or destroyed.

Welcome to the UX96

Thank you for choosing the Yamaha UX96 USB-MIDI interface.

The UX96 is a MIDI interface that features fast data transfer via USB connection and simultaneous playback of up to 96 channels. Connect the UX96 to a computer that has a USB terminal and enjoy the advantages of digital music.

Please read this owner's manual thoroughly to make the best use of the UX96.

After you read this manual, please keep it in a safe place for future reference.

Table of Contents

UX96 Features	5
Package Contents	6
System Requirements	7
Specifications	7
Parts and Functions	8
Connection	9
Installing the Driver	10
Changing the driver setting (MIDI Patch Screen)	20
Troubleshooting (FAQ)	25

- The screen displays in this Owner's Manual are intended for instructional purposes, and may appear somewhat different from the screens that appear on your computer.
- OMS[®] and  are trademarks of Opcode Systems, Inc.
- The company names and product names in this Owner's Manual are the trademarks or registered trademarks of their respective companies.

UX96 Features

● 96-channel Simultaneous Playback

You can use both MIDI IN/OUT terminals and the TO TG/INST terminal (equivalent to a serial port on a computer) simultaneously. In this way, you can build a powerful music production environment with 6 MIDI OUT ports (96 channels) and 2 MIDI IN ports (32 channels).

● Easy Hot Swap Connection

With a USB connection, you can connect and disconnect the USB cable while the power to the computer is on. The UX96 operates on USB bus power and does not require a power adaptor.

● USB Fast Data Transfer

USB connection enables a very quick response during multiport simultaneous performance.

● Supports Windows and Macintosh

The UX96 supports Windows 98/Me/2000 and Mac OS 8.5 or higher (including OS 9.1).

Notes on USB

Never connect or disconnect a USB cable under any of the following conditions. Otherwise, the computer may lock up or UX96 functions may be disabled:

- The computer is checking the device or loading the driver.
- The computer is starting or quitting the OS.
- The computer is in or canceling Save Energy (Sleep) mode.
- A MIDI application program is running.

Also, do not perform any of the following operations. Otherwise, the computer may lock up or the UX96 functions may be disabled:

- Do not frequently connect or disconnect the cables.
- Do not place the computer in or cancel Save Energy (Sleep) mode during MIDI data transfer.
- Do not connect or disconnect cables, restart the computer, or install the driver while a large amount of data is being transferred.

(NOTE) If you are using Windows 2000, Save Energy mode may be disabled depending on your environment (USB Host Controller etc.) Even in this case, if you disconnect and connect the USB cable, UX96 functions will be enabled again.

Package Contents

The UX96 package contains the following items. Check the contents for missing items.

- USB-MIDI interface (UX96 main unit)
- CD-ROM (Windows/Macintosh hybrid CD)
- USB cable
- Owner's manual (this book)

About the included software

The included CD-ROM contains the following software (driver).

[Windows]

- **USB-MIDI driver (YAMAHA USB-MIDI Driver)**
You need this driver to operate the UX96. See page 11 for information on installing the driver.

[Macintosh]

- **OMS**
This is a MIDI driver for Macintosh provided by Opcode Systems. See page 15 and the included "OMS_2.3_Mac.pdf" OMS manual for information on installing and using the driver.
- **USB-MIDI driver (YAMAHA USB-MIDI Driver)**
You need this driver to operate the UX96.
Be sure to install the OMS driver first, then install this driver. See page 15 for information on installing the driver.

System Requirements

[Windows]

OS:	Windows98/Me/2000
Computer:	USB-supported IBM-PC or compatible computer
CPU:	Pentium 166MHz or higher
Memory:	32 MB or higher (64 MB or higher is recommended)
Hard Disk:	2 MB or more of free space

[Macintosh]

OS:	MacOS 8.5 through OS 9.1
Computer:	Macintosh computer with built-in USB port

(NOTE) With some iMac models, you need to install "iMac Update 1.1," provided by Apple Computer. This program improves the USB software. For more information, visit the Apple Computer web site (www.apple.com).

Memory:	64 MB or higher (128 MB or higher is recommended)
---------	---

(NOTE) Turn off virtual memory.

Hard Disk:	2 MB or more of free space
Other:	OMS 2.3.6 or later (included in the CD-ROM in the package)

Specifications

Terminals:	MIDI IN terminal, MIDI OUT terminal, TO TG/INST terminal, USB terminal
Power Supply:	USB bus power supply
Dimensions:	77(W) × 77(D) × 33(H) [mm]
Weight:	80g
Option:	8-pin peripheral cable for Apple Macintosh

Specifications and descriptions in this Owner's Manual are for information purposes only. Yamaha Corp. reserves the right to change or modify products or specifications at any time without prior notice. Since specifications, equipment or options may not be the same in every locale, please check with your Yamaha dealer.

Parts and Functions

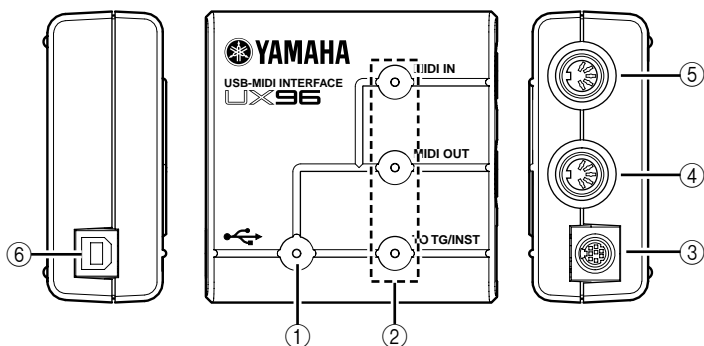

① Power LED

This LED lights up when the USB terminal is connected and the power is being supplied to the UX96.

② Terminal LEDs

These LEDs light up when MIDI signal passes through the corresponding terminals.

③ TO TG/INST terminal

Connect this terminal to the TO HOST terminal on the MIDI device. Use an optional 8-pin system peripheral cable for Apple Macintosh for connection.

NOTE Set the HOST SELECT switch of the connected MIDI device to "PC-1" or "Mac," regardless of the computer you are using.

④ MIDI OUT terminal

This terminal transmits MIDI signals to connected MIDI devices. Use an optional MIDI cable for connection.

⑤ MIDI IN terminal

This terminal receives MIDI signals from connected MIDI devices. Use an optional MIDI cable for connection.

⑥ USB terminal

Connect this terminal to a computer or a USB hub using a USB cable.

Connection

This chapter explains how to connect MIDI devices, such as a tone generator and a MIDI keyboard, to the UX96.

1. Connecting a computer

Connect the USB terminal of a computer to the USB terminal of the UX96 using a USB cable. At this time, you do not have to turn off the power to the computer.

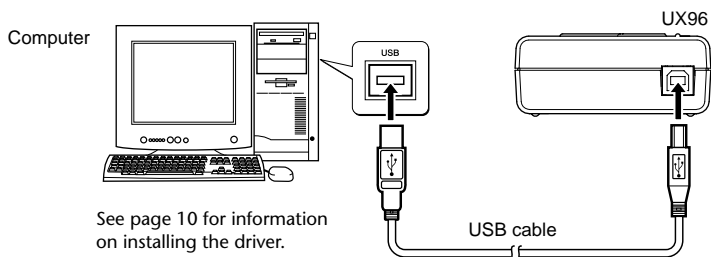

2. Connecting the TO TG/INST terminal to a MIDI device

Connect the TO HOST terminal of a MIDI device to the TO TG/INST terminal of the UX96 using an optional serial cable (8-pin Macintosh peripheral cable). At this time, set the HOST SELECT switch of the MIDI device to "PC-1" or "Mac," regardless of the computer you are using. When you are using the TO TG/INST terminal, you can use five MIDI OUT ports and one MIDI IN port to control the connected MIDI device.

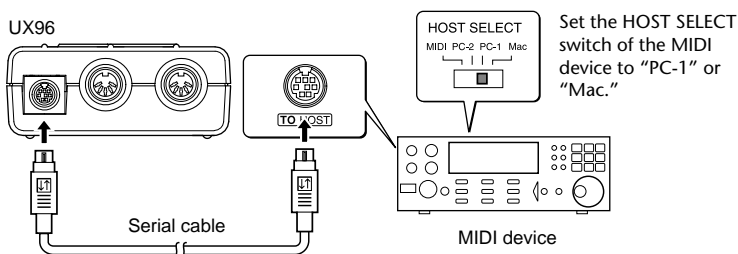

3. Connecting the MIDI terminals to a MIDI device

Use optional MIDI cables to connect the MIDI IN terminal of the MIDI device to the MIDI OUT terminal of the UX96. Also, connect the MIDI OUT terminal of the MIDI device to the MIDI IN terminal of the UX96. At this time, set the HOST SELECT switch of the MIDI device to "MIDI."

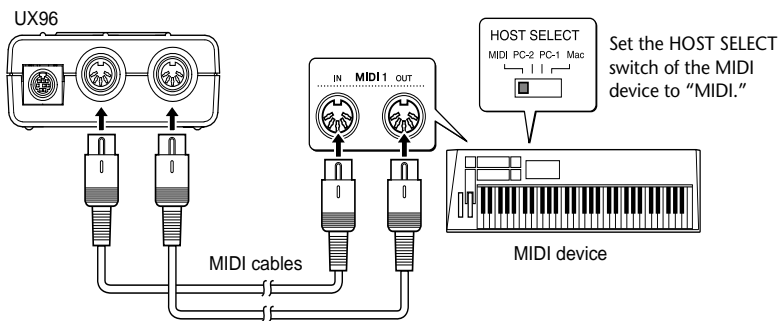

Installing the Driver

To operate the UX96, you need to install the driver on the computer correctly. The USB-MIDI driver is software that transmits MIDI signals back and forth between sequence software and the UX96 via a USB cable. If you are using a Macintosh computer, you also need to install the OMS driver (page 15) as well as the USB-MIDI driver.

■ Windows

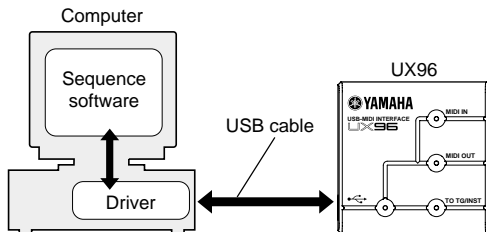

■ Macintosh

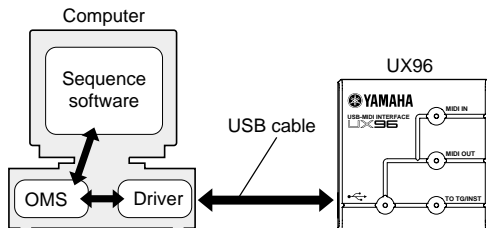

Windows 98/Me users →See page 11.

Windows 2000 users →See page 13.

Macintosh users →See page 15.

Windows users:

● Installing the driver on a Windows98/Me system

1. Start the computer.
2. Insert the included CD-ROM into the CD-ROM drive.
3. Use the included USB cable to connect the USB terminal of the computer (or the USB hub) to the USB terminal of the UX96.
The UX96 is powered on and the system automatically displays the "Add New Hardware Wizard."

(NOTE) For Windows Me users, check the radio button to the left of "Automatic search for a better driver (Recommended)" and click [Next]. The system automatically starts searching and installing the driver. Proceed to Step 8. If the system does not detect the driver, select "Specify the location of the driver (Advanced)" and specify the CD-ROM drive's root directory (e.g., D:\) to install the driver.

Windows 98



Windows Me



4. Click [Next].
The system displays a screen that enables you to select the search method.



5. Check the radio button to the left of “Search for the best driver for your device. (Recommended).” Click [Next].

The system displays a screen that enables you to select a location in which to install the driver.



6. Check the “CD-ROM drive” box and uncheck all other items. Click [Next].

NOTE The system may ask you to insert a Windows CD-ROM while it checks for the driver. Specify the root folder of the CD-ROM drive (such as D:) and continue the installation.

7. When the system detects the driver on the CD-ROM and is ready for installation, it displays the following screen. Make sure that the “YAMAHA USB MIDI Driver” is listed, and click [Next]. The system starts the installation.



8. When the installation is complete, the following screen appears.
Click [Finish].

(NOTE) Some computers may take about ten seconds to show this screen after the installation is complete.

Windows 98



Windows Me



The driver has been installed.

● Installing the driver on a Windows 2000 system

1. Start the computer and use the “Administrator” account to log into Windows 2000.
2. Select [My Computer | Control Panel | System | Hardware | Driver Signing | File Signature verification], and check the radio button on the left of “Ignore - Install all files, regardless of file signature” and click [OK].
3. Insert the included CD-ROM into the CD-ROM drive.
4. Use the included USB cable to connect the USB terminal of the computer (or the USB hub) to the USB terminal of the UX96.
The UX96 is powered on and the system automatically displays the “Found New Hardware Wizard.” Click [Next].
5. Check the radio button to the left of “Search for a suitable driver for my device. (Recommended).” Click [Next].
The system displays a screen that enables you to select a location in which to install the driver.
6. Check the “CD-ROM drives” box and uncheck all other items. Click [Next].
(NOTE) The system may ask you to insert a Windows CD-ROM while it checks for the driver. Specify the root folder of the CD-ROM drive (such as D:\) and continue the installation.
7. When the installation is complete, the system displays “Completing the Found New Hardware Wizard.”
Click [Finish].

(NOTE) Some computers may take about ten seconds to show this screen after the installation is complete.

- Restart the computer.
The driver has been installed.

● Selecting the destination for the MIDI signal output

This section explains how to set up the UX96 for use with Windows Media Player (included in Windows) or an equivalent program. For information on setting up your sequence software, refer to the owner's manual for the software.

Windows Me

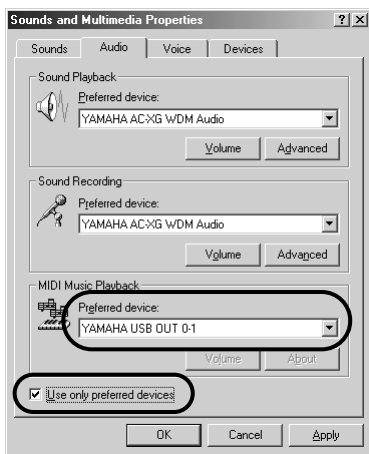

Windows 98

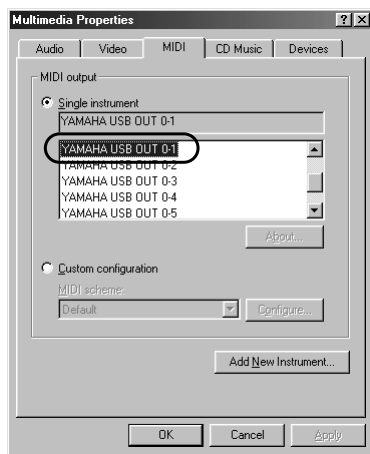

- Select [My Computer | Control Panel] and double-click to open "Sounds and Multimedia (Multimedia)."
(NOTE) For Windows Me users, if you do not see "Sounds and Multimedia" in the "Control Panel," click "View all Control Panel options."
- Click the "Audio (MIDI)" tab.
- Click "Preferred device" in "MIDI Music Playback" to view "YAMAHA USB OUT xx-yy." Select a driver according to the port number of the connected MIDI device. For Windows Me users, check the "Use only preferred devices" checkbox.
(NOTE) The variable "xx" represents the device number (page 21) and "yy" represents the port number (page 20). If only one UX96 is connected, the device number is "0."
(NOTE) For Windows 98 users, select the driver while "Single instrument" is selected.
(NOTE) If "YAMAHA USB OUT xx-yy" is not displayed, the drive has not been installed correctly. Delete the driver (page 26) and re-install the driver.
- Click [OK].

● Using two or more UX96s

Follow the steps below to connect two or more UX96s. You do not need to re-install the driver.

1. Start the computer.
2. Use the included USB cable to connect the USB terminal of the computer (or the USB hub) to the USB terminal of the UX96.

(NOTE) When you turn on the power to connected multiple UX96s, the device number is assigned, starting with 0, to the units in the order in which you turn on the power. If you turn on the power to all units simultaneously, the device number is assigned based on the order of the port numbers of the USB hub. However, this order may change depending on the hub.

Macintosh users:

First install OMS before you install the USB-MIDI driver. Also, after installing the driver, you will need to set up OMS (page 17).

● Installing OMS

1. Start the computer.
2. Insert the included CD-ROM into the CD-ROM drive. The system displays the CD-ROM icon on the desktop.
3. Double-click to open the CD-ROM icon and double-click the "Install OMS 2.3.6" icon in the "OMS 2.3.6" folder inside "OMS E."

Follow the instructions on the screen to install OMS. For more information on installing and using OMS, refer to the included "OMS_2.3_Mac.pdf" manual.

● Installing the USB-MIDI driver

1. Start the computer.
2. Insert the included CD-ROM into the CD-ROM drive. The system displays the CD-ROM icon on the desktop.

3. Double-click the CD-ROM icon and double-click the “Install USB Driver” icon to display the following installation screen.



4. The “Install Location” box displays the destination of the installation. If you wish to change the destination disk or folder, use the [Switch Disk] button and the pop-up menu to specify the desired destination.

(NOTE) This box usually displays the start-up disk as the destination.

5. Click the [Install] button. The system displays the following message: “This installation requires your computer to restart after installing this software. Click Continue to automatically quit all other running applications.” Click [Continue].

(NOTE) To cancel the installation, click [Cancel].

6. The installation starts. If the driver has already been installed, you will receive the following message. To return to step 3, press [Continue]. To complete the installation, click [Quit].

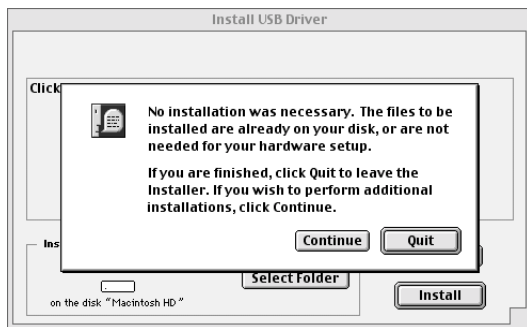

7. When the installation is complete, the system displays the following message: "Installation was successful. You have installed software which requires you to restart your computer." Click [Restart]. The computer automatically restarts. You can locate the installed files in the following locations:
- System Folder | Control Panels | YAMAHA USB MIDI Patch
 - System Folder | Extensions | USB YAMAHA MIDI Driver
 - System Folder | OMS Folder | YAMAHA USB MIDI OMS Driver

● Setting up OMS

1. Start the computer.
2. Use the included USB cable to connect the USB terminal of the computer (or the USB hub) to the USB terminal of the UX96. Make sure that the UX96 is powered on and the power LED lights up.
3. Open the "OMS Applications" folder in the "Opcode" folder installed on the hard disk, and double-click the "OMS Setup" icon to start the setup program.
4. If the AppleTalk dialog appears, click [Turn It Off], then click [OK] in the subsequent dialog box.
5. The system displays the "Create a New Studio Setup" dialog box. If this dialog box does not appear, select "New Studio Setup" from the "File" menu.
6. Click [OK]. The system displays the "OMS Driver Search" dialog box. Remove the check from the "Modem" and "Printer" check boxes, and click [Search].

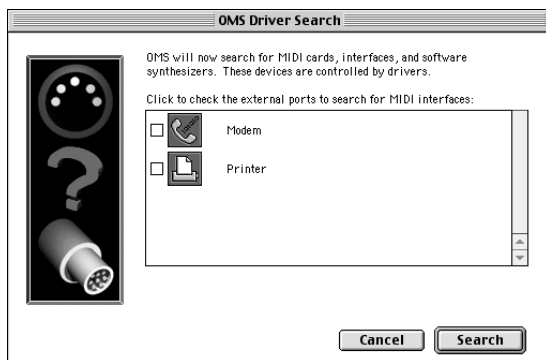

7. After the search operation is complete, make sure that “USB-MIDI 1” is listed in the “OMS Driver Setup” dialog, then click [OK].

NOTE If the UX96 is not detected correctly, “USB-MIDI 1” does not appear. Check the cable connection and repeat the procedure from the beginning.

NOTE If your iMac does not detect the UX96, “iMac Update 1.1” may not have been installed. See page 7 for more information.

NOTE The system displays one “USB-MIDI x” message for each connected UX96.

8. Make sure that “USB-MIDI 1” and multiple Port numbers are listed in the “OMS MIDI Device Setup” dialog. Check all Ports 1–6 check boxes. Click [OK].

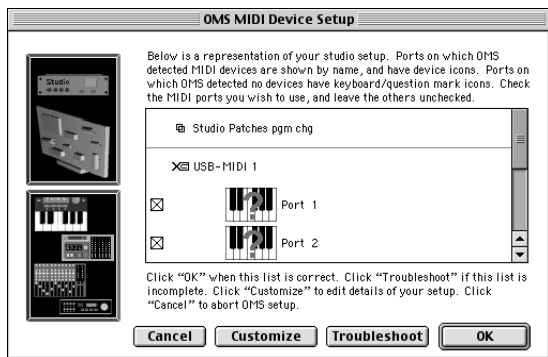

9. The system displays a dialog box that enables you to save the setup file. Enter the file name and click [Save].

10. After you save the file, the system displays the following window.
The setting is complete if a “◇” mark appears before the file name.

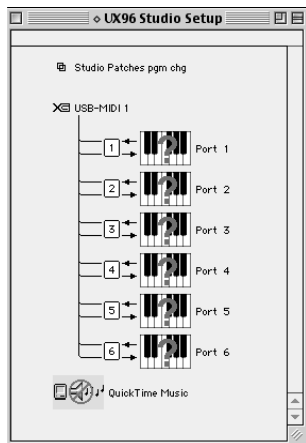

You can also improve the setup view by changing the name and icon for each port. For more information, refer to the included “OMS_2.3_Mac.pdf.”

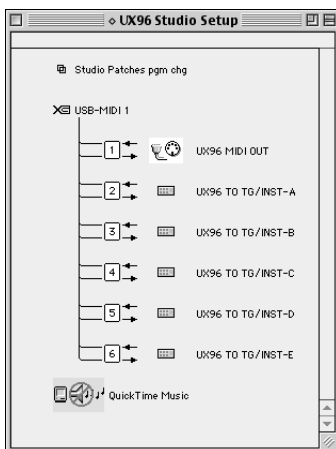

The driver installation and OMS setup is now complete.

● Using two or more UX96s

First connect multiple UX96s, then proceed to the OMS setup procedure (page 17).

Changing the driver setting (MIDI Patch Screen)

You can change the assignment of I/O ports on the UX96 and port numbers selected from your computer.

Sequence software transmits and receives MIDI signals to and from the UX96 via the driver (page 10). The UX96 features MIDI IN/OUT terminals and a TO TG/INST terminal. Select the I/O ports on the UX96 from your computer (sequence software). You specify the I/O ports of the UX96 using the computer's sequence software. Changing the driver setting enables you to change I/O assignments without re-patching cables.

For example, you can transmit an identical MIDI signal to multiple ports, or transmit layered MIDI signals from multiple ports to a single port. Also, you can directly route MIDI signals from MIDI IN to MIDI OUT.

The following table shows the assignment of the port numbers and I/O ports. With the default settings, the port number matches the computer's port number.

port number	MIDI output port	MIDI input port
Port 1	MIDI OUT	MIDI IN
Port 2	TO TG/INST -A	TO TG/INST
Port 3	TO TG/INST -B	—
Port 4	TO TG/INST -C	—
Port 5	TO TG/INST -D	—
Port 6	TO TG/INST -E	—

NOTE If a tone generator connected to the TO TG/INST terminal does not support multiport specifications, the selection of ports B–E will be ignored.

● Starting the MIDI Patch screen

The start-up method and the MIDI Patch screen differ slightly for Windows and Macintosh systems. However, the basic operation of the screen is the same. The following section explains how to operate the MIDI Patch screen on a Windows system.

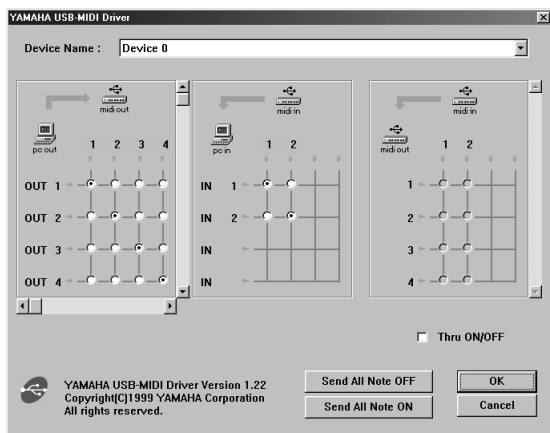

[Windows]

1. Double-click "Control Panel" in the "My Computer" folder.
2. Double-click "MIDI-USB Driver" to display the screen.

[Macintosh]

Select "Control Panels" from the Apple menu, then select "YAMAHA USB MIDI Patch" to display the screen.

● Changing the device number

If you are using multiple UX96s, you can change the device number. Click "Device Name." The System displays the drop-down list. Select the device for which you wish to change the setting.

(NOTE) If you are using a Macintosh computer, the device number is assigned sequentially, such as "USB1," "USB2," etc., as the Device Name.

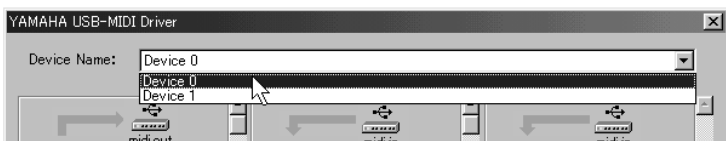

● Checking the signal path

To see if the MIDI device is connected correctly, you can try transmitting MIDI signals.

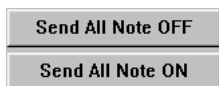

● Note Off Message

When you click [Send All Note OFF], a MIDI All Note Off message will be sent to all ports on the UX96.

● Note On Message

When you click [Send All Note On], a MIDI All Note On message will be sent to all ports on the UX96.

● Changing connections during playback (PC OUT → MIDI OUT)

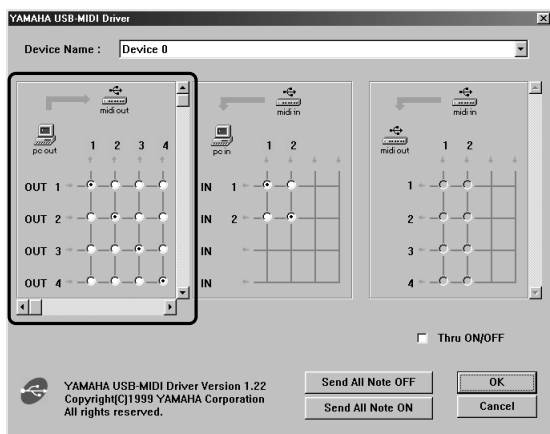

You can change the I/O assignment of the computer's output port and the UX96's output port. The left column shows the computer's output ports (OUT 1–6), and the top column shows the UX96's output ports (1–6). With the default settings, ports with the same number are connected to each other. However, you can change these settings by checking the check boxes.

If you check multiple check boxes vertically, MIDI signals from multiple output ports on the computer are merged and transmitted to one output port on the UX96. If you check multiple check boxes horizontally, a MIDI signal from one output port on the computer is distributed to multiple output ports on the UX96.

NOTE See page 20 for more information on the relationship between the UX96's I/O ports and the port numbers.

● Changing connections during recording (MIDI IN → PC IN)

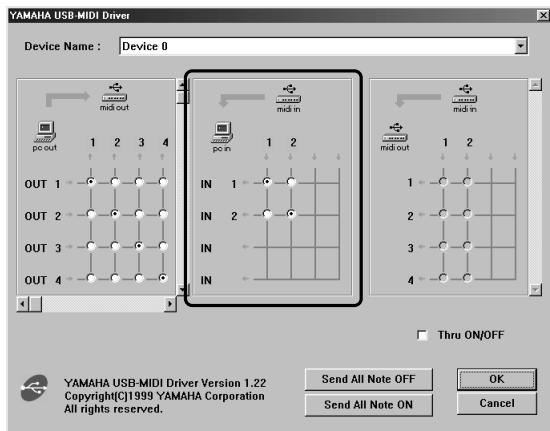

You can change the I/O assignment of the computer's input port and the UX96's input port. The left column shows the computer's input ports (IN 1–2), and the top column shows the UX96's input ports (1–2). With the default settings, ports with the same number are connected to each other. However, you can change these settings by checking the check boxes.

If you check multiple check boxes vertically, a MIDI signal from one input port on the UX96 is distributed to multiple input ports on the computer. If you check multiple check boxes horizontally, MIDI signals from multiple input ports on the UX96 are merged and transmitted to one input port on the computer.

(NOTE) See page 20 for more information on the relationship between the UX96's I/O ports and the port numbers.

● THRU output of MIDI signals (MIDI IN → MIDI OUT)

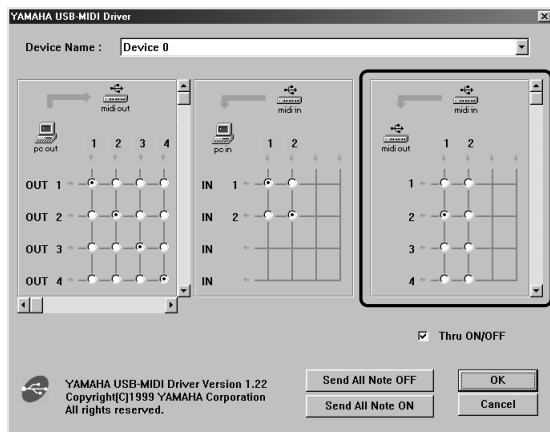

You can route MIDI signals received at the input port(s) of the UX96 directly to the output port(s) of the UX96 (this is called THRU output). This routing is useful when you wish to route MIDI signals from a MIDI keyboard directly to a tone generator. The left column shows the UX96's output ports (1–6), and the top column shows the UX96's input ports (1–2). To enable this function, check the "Thru ON/OFF" check box in the lower right corner of the screen.

If you check multiple check boxes vertically, a MIDI signal from one input port on the UX96 is distributed to multiple output ports on the UX96. If you check multiple check boxes horizontally, MIDI signals from multiple input ports on the UX96 are merged and transmitted to one output port on the UX96.

NOTE See page 20 for more information on the relationship between the UX96's I/O ports and the port numbers.

NOTE For Macintosh, this function is valid only when the MIDI Patch screen or sequence software is running.

Troubleshooting (FAQ)

● The driver cannot be installed.

• Is the USB cable connected correctly?

- Check the USB cable connection. (page 9)
- Disconnect the USB cable, then connect it again.

• [Windows] Is the USB function enabled on your computer?

- When you connect the UX96 to the computer for the first time, if the “Add New Hardware Wizard” (pages 11 and 13) does not appear, the USB function on the computer may be disabled. Perform the following steps.

1. Double-click “System” in the Control Panel to open the System Properties window.
2. Double-click the “Device Manager” tab and make sure that no “!” or “x” marks appear at “Universal serial bus controller” or “USB Root Hub.” If you see the “!” or “x” mark, the USB controller is disabled. For more information, refer to the owner’s manual of your computer.

• [Windows] Is any unknown device registered?

- If driver installation fails, the UX96 will be evaluated as an “Unknown device,” and you will not be able to install the driver. Delete the “Unknown device” by following the steps below.

1. Double-click “System” in the Control Panel to open the System Properties window.
2. Double-click the “Device Manager” tab. With the “View devices by type” check box checked, look for “Other devices.”
3. If you find “Other devices,” double-click it to extend the tree to look for “Unknown device.” If one appears, select it and click the [Remove] button.
4. Remove the USB cable from the UX96, and make the connection again.
5. Install the driver by following the steps (starting from Step 3) described on page 11.

● The UX96 does not operate correctly, or no sound is heard.

- Did you install the driver? (page 10)
- Are the USB cable, MIDI cables, serial cables, and audio cables connected correctly? (page 9)
- Is the volume setting of the tone generator, playback device, and application program set to the appropriate level?
- Is the HOST SELECT switch on the tone generator set correctly?
 - If the tone generator is connected to the MIDI IN/OUT terminals, set the switch to "MIDI." If the tone generator is connected to the TO TG/INST terminal, set the switch to "PC-1" or "Mac," regardless of the computer you are using.
- Have you selected an appropriate port in the sequence software?

● Playback response is delayed.

- Does your computer satisfy the system requirements? (page 7)
- Is any other application or device driver running?

[Macintosh]

- Turn off virtual memory.
- Disable AppleTalk.

● Cannot suspend or resume the computer correctly.

- Do not suspend the computer while the MIDI application is running.
- If you are using Windows 2000, Save Energy mode may be disabled depending on your environment (USB Host Controller etc.) Even in this case, if you disconnect and connect the USB cable, UX96 functions will be enabled again.

● How can I delete or re-install the driver?

[Windows Me/98]

1. When the UX96 is recognized correctly, double-click "System" in the Control Panel to open the System window.
2. Double-click the "Device Manager" tab, select "YAMAHA USB MIDI Driver" and delete it.
3. Use MS-DOS prompt or Internet Explorer to delete the following three files.

(NOTE) To delete these files using Explorer, select "Folder Options" from the Tool (View) menu, and select "Show all files (and folders)."

- \WINDOWS\INF\OTHER\YAMAHAUX96.INF
 - \WINDOWS\SYSTEM\Xgusb.driv
 - \WINDOWS\SYSTEM\Ymidusb.sys
4. Disconnect the USB cable.
 5. Restart the computer.
 6. Re-install the driver according to the instructions on page 11.

[Macintosh]

1. Delete the files in the following locations:
 - System Folder | Control Panels | YAMAHA USB MIDI Patch
 - System Folder | Extensions | USB YAMAHA MIDI Driver
 - System Folder | OMS Folder | YAMAHA USB MIDI OMS Driver
2. Restart the computer.
3. Install the driver (page 15) and set up OMS (page 17).

FCC INFORMATION (U.S.A.)

1. IMPORTANT NOTICE: DO NOT MODIFY THIS UNIT!

This product, when installed as indicated in the instructions contained in this manual, meets FCC requirements. Modifications not expressly approved by Yamaha may void your authority, granted by the FCC, to use the product.

2. IMPORTANT:

When connecting this product to accessories and/or another product use only high quality shielded cables. Cable/s supplied with this product MUST be used. Follow all installation instructions. Failure to follow instructions could void your FCC authorization to use this product in the USA.

3. NOTE:

This product has been tested and found to comply with the requirements listed in FCC Regulations, Part 15 for Class "B" digital devices. Compliance with these requirements provides a reasonable level of assurance that your use of this product in a residential environment will not result in harmful interference with other electronic devices. This equipment generates/uses radio frequencies and, if not installed and used according to the instructions found in the users manual, may cause interference harmful to the operation

of other electronic devices.

Compliance with FCC regulations does not guarantee that interference will not occur in all installations. If this product is found to be the source of interference, which can be determined by turning the unit "OFF" and "ON", please try to eliminate the problem by using one of the following measures:

Relocate either this product or the device that is being affected by the interference.

Utilize power outlets that are on different branch (circuit breaker or fuse) circuits or install AC line filter/s.

In the case of radio or TV interference, relocate/reorient the antenna. If the antenna lead-in is 300 ohm ribbon lead, change the lead-in to co-axial type cable.

If these corrective measures do not produce satisfactory results, please contact the local retailer authorized to distribute this type of product. If you can not locate the appropriate retailer, please contact Yamaha Corporation of America, Electronic Service Division, 6600 Orangethorpe Ave, Buena Park, CA90620

The above statements apply ONLY to those products distributed by Yamaha Corporation of America or its subsidiaries.

* This applies only to products distributed by YAMAHA CORPORATION OF AMERICA.

(class B)

CANADA

This Class B digital apparatus complies with Canadian ICES-003.

Cet appareil numérique de la classe B est conforme à la norme NMB-003 du Canada.

(class B)

- This applies only to products distributed by Yamaha Canada Music Ltd.
- Ceci ne s'applique qu'aux produits distribués par Yamaha Canada Musique Ltée.

For details of products, please contact your nearest Yamaha or the authorized distributor listed below.
Pour plus de détails sur les produits, veuillez-vous adresser à Yamaha ou au distributeur le plus proche de vous figurant dans la liste suivante.

Die Einzelheiten zu Produkten sind bei Ihrer unten aufgeführten Niederlassung und bei Yamaha Vertragshändlern in den jeweiligen Bestimmungsländern erhältlich.
Para detalles sobre productos, contacte su tienda Yamaha más cercana o el distribuidor autorizado que se lista debajo.

NORTH AMERICA

CANADA

Yamaha Canada Music Ltd.
135 Milner Avenue, Scarborough, Ontario,
M1S 3R1, Canada
Tel: 416-298-1311

U.S.A.

Yamaha Corporation of America
6600 Orangeflour Ave., Buena Park,
Calif. 90620, U.S.A.
Tel: 714-522-9011

CENTRAL & SOUTH AMERICA

MEXICO

**Yamaha de Mexico S.A. De C.V.,
Departamento de ventas**
Javier Rogo Gomez No.1149, Col. Gpe Del
Moral, Deleg. Iztapalapa, 09300 Mexico,
D.F.
Tel: 686-00-33

BRAZIL

Yamaha Musical do Brasil LTDA.
Av. Rebouças 2636, São Paulo, Brasil
Tel: 011-853-1377

ARGENTINA

Yamaha Music Argentina S.A.
Viamonte 1145 Piso 2-B 1053,
Buenos Aires, Argentina
Tel: 1-4371-7021

PANAMA AND OTHER LATIN AMERICAN COUNTRIES/ CARIBBEAN COUNTRIES

Yamaha de Panama S.A.
Torre Banco General, Piso 7, Urbanización
Marbella, Calle 47 y Aquilino de la
Guardia, Ciudad de Panamá, Panamá
Tel: 507-269-5311

EUROPE

THE UNITED KINGDOM

Yamaha-Kemble Music (U.K.) Ltd.
Sherbourne Drive, Tilbrook,
Milton Keynes, MK7 8BL, England
Tel: 01908-366700

IRELAND

Danfay Ltd.
61D, Sallynoggin Road, Dun Laoghaire,
Co. Dublin
Tel: 01-2859177

GERMANY/SWITZERLAND

Yamaha Europa GmbH.
Siemensstraße 22-34, 25462 Rellingen,
F.R. of Germany
Tel: 04101-3030

AUSTRIA

Yamaha Music Austria
Schleiergasse 20, A-1100 Wien Austria
Tel: 01-60203900

THE NETHERLANDS

Yamaha Music Nederland
Kanaalweg 18G, 3526KL, Utrecht,
The Netherlands
Tel: 030-2828411

BELGIUM

Yamaha Music Belgium
Keiberg Imperiastraat 8, 1930 Zaventem,
Belgium
Tel: 02-7258220

FRANCE

**Yamaha Musique France,
Division Professionnelle**
BP 70-77312 Marné-la-Vallée Cedex 2,
France
Tel: 01-64-61-4000

ITALY

**Yamaha Musica Italia S.P.A.,
Combo Division**
Viale Italia 88, 20020 Lainate (Milano),
Italy
Tel: 02-935-771

SPAIN/PORTUGAL

Yamaha-Hazen Electronica Musical, S.A.
Ctra. de la Coruna km. 17, 200, 28230
Las Rozas (Madrid) Spain
Tel: 91-201-0700

GREECE

Philippe Nakas S.A.
Navarinou Street 13, P.Code 10680,
Athens, Greece
Tel: 01-364-7111

SWEDEN

Yamaha Scandinavia AB
J. A. Wettergrens Gata 1 Box 30053
S-400 43 Göteborg, Sweden
Tel: 031 89 34 00

DENMARK

YS Copenhagen Liaison Office
Generatorvej 8B DK-2730 Herlev, Denmark
Tel: 44 92 49 00

FINLAND

F-Musiikki Oy
Kluuvikatu 6, P.O. Box 260,
SF-00101 Helsinki, Finland
Tel: 09 618511

NORWAY

Norsk filial av Yamaha Scandinavia AB
Grini Næringspark 1
N-1345 Østerås, Norway
Tel: 67 16 77 70

ICELAND

Skitan HF
Skeifan 17 P.O. Box 8120
IS-128 Reykjavik, Iceland
Tel: 525 5000

OTHER EUROPEAN COUNTRIES

Yamaha Europa GmbH.
Siemensstraße 22-34, 25462 Rellingen,
F.R. of Germany
Tel: 04101-3030

AFRICA

**Yamaha Corporation,
Asia-Pacific Music Marketing Group**
Nakazawa-cho 10-1, Hamamatsu,
Japan 430-8650
Tel: 053-460-2312

MIDDLE EAST

TURKEY/CYPRUS

Yamaha Europa GmbH.
Siemensstraße 22-34, 25462 Rellingen,
F.R. of Germany
Tel: 04101-3030

OTHER COUNTRIES

Yamaha Music Gulf FZE
LB21-128 Jebel Ali Freezone
P.O.Box 17328, Dubai, U.A.E.
Tel: 971-4-881-5868

ASIA

HONG KONG

Tom Lee Music Co., Ltd.
11/F., Silvercord Tower 1, 30 Canton Road,
Tsimshatsui, Kowloon, Hong Kong
Tel: 2737-7688

INDONESIA

**PT. Yamaha Music Indonesia (Distribu-
tor) PT. Nusantara**
Gedung Yamaha Music Center, Jalan Jend.
Gatot Subroto Kav. 4, Jakarta 12930, Indonesia
Tel: 21-520-2577

KOREA

Cosmos Corporation
1461-9, Seocho Dong, Seocho Gu, Seoul, Korea
Tel: 02-3486-0011

MALAYSIA

Yamaha Music Malaysia, Sdn., Bhd.
Lot 8, Jalan Perbandaran, 47301 Kelana
Jaya, Petaling Jaya, Selangor, Malaysia
Tel: 3-703-0900

PHILIPPINES

Yupango Music Corporation
339 Gil J. Puyat Avenue, P.O. Box 885
MCPD, Makati, Metro Manila, Philippines
Tel: 819-7551

SINGAPORE

Yamaha Music Asia Pte., Ltd.
11 Ubi Road #06-00,
Meiban Industrial Building, Singapore
Tel: 65-747-4374

TAIWAN

Yamaha KHS Music Co., Ltd.
10F, 150, Tun-Hwa Northroad, Taipei,
Taiwan, R.O.C.
Tel: 02-2713-8999

THAILAND

Siam Music Yamaha Co., Ltd.
121/60-61 RS Tower 17th Floor,
Ratchadaphisek RD., Dindaeng,
Bangkok 10320, Thailand
Tel: 02-641-2951

THE PEOPLE'S REPUBLIC OF CHINA AND OTHER ASIAN COUNTRIES

**Yamaha Corporation,
Asia-Pacific Music Marketing Group**
Nakazawa-cho 10-1, Hamamatsu,
Japan 430-8650
Tel: 053-460-2317

OCEANIA

AUSTRALIA

Yamaha Music Australia Pty. Ltd.
Level 1, 99 Queensbridge Street,
Southbank, Victoria 3006, Australia
Tel: 3-9693-5111

NEW ZEALAND

Musik Houses of N.Z. Ltd.
146/148 Captain Springs Road, Te Papapa,
Auckland, New Zealand
Tel: 9-634-0099

COUNTRIES AND TRUST TER- RITORIES IN PACIFIC OCEAN

**Yamaha Corporation,
Asia-Pacific Music Marketing Group**
Nakazawa-cho 10-1, Hamamatsu,
Japan 430-8650
Tel: 053-460-2312

HEAD OFFICE

Yamaha Corporation, Pro Audio & Digital Musical Instrument Division
Nakazawa-cho 10-1, Hamamatsu, Japan 430-8650
Tel: 053-460-2445



Yamaha Web Site (English only)
www.yamahasyth.com
Yamaha Manual Library (English versions only)
<http://www2.yamaha.co.jp/manual/english/>

This document is printed on recycled chlorine free (ECF) paper with soy ink.
Auf Recycling-Umweltpapier gedruckt.
Ce document a été imprimé sur du papier recyclé non blanchi au chlore.

M.D.G., PA•DMI Division, Yamaha Corporation
© 2001 Yamaha Corporation

V754770 104APAP7.2-01A0 Printed in Japan