

USB AUDIO/MIDI PERSONAL STUDIO

UW500

English

Deutsch

Français

**Owner's Manual
Bedienungsanleitung
Mode d'emploi**

SPECIAL MESSAGE SECTION

This product utilizes batteries or an external power supply (adapter). DO NOT connect this product to any power supply or adapter other than one described in the manual, on the name plate, or specifically recommended by Yamaha.

WARNING: Do not place this product in a position where anyone could walk on, trip over, or roll anything over power or connecting cords of any kind. The use of an extension cord is not recommended! IF you must use an extension cord, the minimum wire size for a 25' cord (or less) is 18 AWG. NOTE: The smaller the AWG number, the larger the current handling capacity. For longer extension cords, consult a local electrician.

This product should be used only with the components supplied or; a cart, rack, or stand that is recommended by Yamaha. If a cart, etc., is used, please observe all safety markings and instructions that accompany the accessory product.

SPECIFICATIONS SUBJECT TO CHANGE:

The information contained in this manual is believed to be correct at the time of printing. However, Yamaha reserves the right to change or modify any of the specifications without notice or obligation to update existing units.

This product, either alone or in combination with an amplifier and headphones or speaker/s, may be capable of producing sound levels that could cause permanent hearing loss. DO NOT operate for long periods of time at a high volume level or at a level that is uncomfortable. If you experience any hearing loss or ringing in the ears, you should consult an audiologist.

IMPORTANT: The louder the sound, the shorter the time period before damage occurs.

Some Yamaha products may have benches and / or accessory mounting fixtures that are either supplied with the product or as optional accessories. Some of these items are designed to be dealer assembled or installed. Please make sure that benches are stable and any optional fixtures (where applicable) are well secured BEFORE using.

Benches supplied by Yamaha are designed for seating only. No other uses are recommended.

NOTICE:

Service charges incurred due to a lack of knowledge relating to how a function or effect works (when the unit is operating as designed) are not covered by the manufacturer's warranty, and are therefore the owners responsibility. Please study this manual carefully and consult your dealer before requesting service.

ENVIRONMENTAL ISSUES:

Yamaha strives to produce products that are both user safe and environmentally friendly. We sincerely believe that our products and the production methods used to produce them, meet these goals. In keeping with both the letter and the spirit of the law, we want you to be aware of the following:

Battery Notice:

This product MAY contain a small non-rechargeable battery which (if applicable) is soldered in place. The average life span of this type of battery is approximately five years. When replacement becomes necessary, contact a qualified service representative to perform the replacement.

This product may also use "household" type batteries. Some of these may be rechargeable. Make sure that the battery being charged is a rechargeable type and that the charger is intended for the battery being charged.

When installing batteries, do not mix batteries with new, or with batteries of a different type. Batteries MUST be installed correctly. Mismatches or incorrect installation may result in overheating and battery case rupture.

Warning:

Do not attempt to disassemble, or incinerate any battery. Keep all batteries away from children. Dispose of used batteries promptly and as regulated by the laws in your area. Note: Check with any retailer of household type batteries in your area for battery disposal information.

Disposal Notice:

Should this product become damaged beyond repair, or for some reason its useful life is considered to be at an end, please observe all local, state, and federal regulations that relate to the disposal of products that contain lead, batteries, plastics, etc. If your dealer is unable to assist you, please contact Yamaha directly.

NAME PLATE LOCATION:

The name plate is located on the top panel of the product. The name plate lists the product's model number, power requirements, and other information. The serial number is located on the rear panel. Please record the model number, serial number, and date of purchase in the spaces provided below, and keep this manual as a permanent record of your purchase.

Model

Serial No.

Purchase Date

PRECAUTIONS

PLEASE READ CAREFULLY BEFORE PROCEEDING

* Please keep these precautions in a safe place for future reference.



WARNING

Always follow the basic precautions listed below to avoid the possibility of serious injury or even death from electrical shock, short-circuiting, damages, fire or other hazards. These precautions include, but are not limited to, the following:

- Do not open the instrument or attempt to disassemble the internal parts or modify them in any way. The instrument contains no user-serviceable parts. If it should appear to be malfunctioning, discontinue use immediately and have it inspected by qualified Yamaha service personnel.
- Do not expose the instrument to rain, use it near water or in damp or wet conditions, or place containers on it containing liquids which might spill into any openings.
- If the AC adaptor cord or plug becomes frayed or damaged, or if there is a sudden loss of sound during use of the instrument, or if any unusual smells or smoke should appear to be caused by it, immediately turn off the power switch, disconnect the adaptor plug from the outlet, and have the instrument inspected by qualified Yamaha service personnel.
- Use the specified adaptor (PA-3B or an equivalent recommended by Yamaha) only. Using the wrong adaptor can result in damage to the instrument or overheating.
- Before cleaning the instrument, always remove the electric plug from the outlet. Never insert or remove an electric plug with wet hands.
- Check the electric plug periodically and remove any dirt or dust which may have accumulated on it.



CAUTION

Always follow the basic precautions listed below to avoid the possibility of physical injury to you or others, or damage to the instrument or other property. These precautions include, but are not limited to, the following:

- Do not place the AC adaptor cord near heat sources such as heaters or radiators, and do not excessively bend or otherwise damage the cord, place heavy objects on it, or place it in a position where anyone could walk on, trip over, or roll anything over it.
- When removing the electric plug from the instrument or an outlet, always hold the plug itself and not the cord.
- Do not connect the instrument to an electrical outlet using a multiple-connector. Doing so can result in lower sound quality, or possibly cause overheating in the outlet.
- Unplug the AC power adaptor when not using the instrument, or during electrical storms.
- Before connecting the instrument to other electronic components, turn off the power for all components. Before turning the power on or off for all components, set all volume levels to minimum. Also, be sure to set the volumes of all components at their minimum levels and gradually raise the volume controls while playing the instrument to set the desired listening level.
- Do not expose the instrument to excessive dust or vibrations, or extreme cold or heat (such as in direct sunlight, near a heater, or in a car during the day) to prevent the possibility of panel disfiguration or damage to the internal components.
- Do not use the instrument near other electrical products such as televisions, radios, or speakers, since this might cause interference which can affect proper operation of the other products.
- Do not place the instrument in an unstable position where it might accidentally fall over.
- Before moving the instrument, remove all connected adaptor and other cables.
- When cleaning the instrument, use a soft, dry cloth. Do not use paint thinners, solvents, cleaning fluids, or chemical-impregnated wiping cloths. Also, do not place vinyl, plastic or rubber objects on the instrument, since this might discolor the panel or keyboard.
- Do not rest your weight on, or place heavy objects on the instrument, and do not use excessive force on the buttons, switches or connectors.
- Do not operate the instrument for a long period of time at a high or uncomfortable volume level, since this can cause permanent hearing loss. If you experience any hearing loss or ringing in the ears, consult a physician.

Yamaha cannot be held responsible for damage caused by improper use or modifications to the instrument, or data that is lost or destroyed.

Always turn the power off when the instrument is not in use.

Welcome to the UW500

Thank you for choosing the Yamaha UW500 USB Audio/MIDI Personal Studio. The UW500 is a USB interface that enables simultaneous transfer of audio and MIDI data. Connect the UW500 to a computer that has a USB port and enjoy the powerful features of digital audio.

Please read this owner's manual thoroughly to make the best use of the UW500. After you read this manual, please keep it in a safe place for future reference.

SPECIAL NOTICES

- The software and this owner's manual are exclusive copyrights of Yamaha Corporation.
- Use of the software and this manual is governed by the license agreement which the purchaser fully agrees to upon breaking the seal of the software packaging. (Please read carefully the Software Licensing Agreement at the end of this manual before installing the application.)
- Copying of the software or reproduction of this manual in whole or in part by any means is expressly forbidden without the written consent of the manufacturer.
- Yamaha makes no representations or warranties with regard to the use of the software and documentation and cannot be held responsible for the results of the use of this manual and the software.
- This disk is a CD-ROM. Do not attempt to play the disk on an audio CD player. Doing so may result in irreparable damage to your audio CD player.
- Copying of the commercially available music sequence data and/or digital audio files is strictly prohibited except for your personal use.
- The company names and product names in this Owner's Manual are the trademarks or registered trademarks of their respective companies.
- The screen displays as illustrated in this Owner's Manual are for instructional purposes, and may appear somewhat different from the screens which appear on your computer.
- Future upgrades of application and system software and any changes in specifications and functions will be announced separately.

* "SoftSynthesizer" is a trademark of Yamaha Corporation.

Table of contents

UW500 Features	6
Notes on USB	7
Notes on musical copyrights	8
Package Contents	9
About the included software	9
System Requirements	11
Parts and Functions	12
Connection	16
Installing the Driver	22
Playing the Demo Song	32
Hard Disk Recording	34
Creating a Song Using Sample Phrases	40
Changing the driver setting (MIDI Patch Screen)	44
Specifications	50
Troubleshooting (FAQ)	51

UW500 Features

- **Transferring audio and MIDI data simultaneously**

You can use audio data and MIDI data at the same time.

The audio inputs and outputs of the UW500 support both analog signals (microphone input and line input/output) and digital signals (optical input/output). MIDI data is transferred via the MIDI IN/OUT terminals and TO TG terminal (which is equivalent to a computer's serial port). Multiple-port configuration (6 MIDI outputs and 2 MIDI inputs) reinforces a powerful musical production environment.

- **Producing a clear sound**

Usually, if you try to record audio using a computer's audio input jack, computer noise is introduced and lowers the audio quality during the analog-to-digital conversion. The UW500, however, converts analog input signals into digital, which enables you to record clear sound to your hard disk.

- **The included software supports a musical production environment**

Using the included software, XGworks and TWE facilitate hard disk recording. Even without external tone generators, you can play both audio data and MIDI data simultaneously using SoftSynthesizer S-YXG50.

- **Easy Hot Swap Connection**

With a USB connection, you can connect and disconnect the USB cable while the power to the computer is on. You can also use the unit as soon as you install the driver.

- **USB Fast Data Transfer**

USB connection enables a quick response from any connected devices during simultaneous audio and MIDI data performance.

USB

USB is an abbreviation for Universal Serial Bus. It is a serial interface for connecting a computer with peripheral devices, and enables much faster data transfer (12Mbps) compared to conventional serial port connections. Also, it allows "hot swapping" (connecting peripheral devices while the power to the computer is on).

Notes on USB

Don't turn the power to the UW500 on or off, or connect or disconnect a USB cable under any of the following conditions. Otherwise, the computer may lock up or UW500 functions may be disabled:

- **The computer is checking the device or loading the driver.**
- **The computer is starting or quitting the OS.**
- **The computer is in Save Energy (Sleep) mode or canceling the mode.**
- **The audio/MIDI application is started.**

Also, don't perform any of the following operations. Otherwise, the computer may lock up or the UW500 functions may be disabled:

- **Do not frequently turn on and off the power to the UW500 or connect and disconnect the cable.**
- **Do not place the computer in Save Energy (Sleep) mode or cancel the mode during audio/MIDI data transfer.**
- **Do not connect or disconnect the USB cable while the UW500 is on.**
- **Do not turn the power to the UW500 on or off, start the computer, or install the driver while a large quantity of data is being transferred.**

Notes on musical copyrights

The UW500 supports SCMS (Serial Copy Management System) to protect the copyrights of music software. When you digitally copy data from CDs, or other music software purchased from stores, to your own media (such as MDs), information regarding digital recording generation is also recorded. If you route the recorded data to the DIGITAL IN jack, the data cannot be recorded on the computer. Use analog inputs (INPUT 1-3 jacks) to record data on the computer.

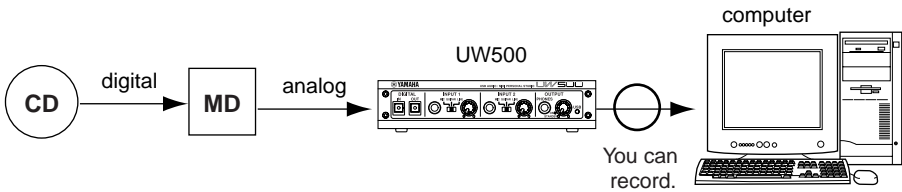
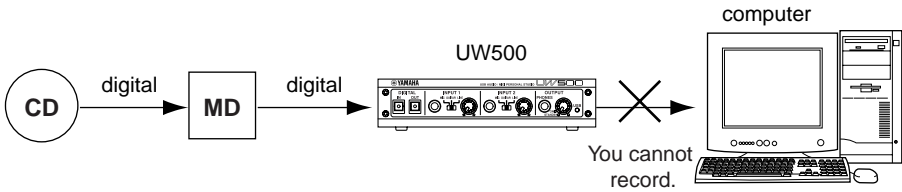

It is prohibited to use copyrighted songs and sound data (that can be recorded via the UW500) for commercial purposes. It is also prohibited to reproduce, transfer, or distribute the data, or play the data for a commercial audience without permission from the owners of the copyright, except for personal use or application that does not infringe the copyright. If you wish to use such data for occasions other than personal use, consult a copyright expert. Yamaha is not responsible for any data created, reproduced, or edited using the UW500, nor for any reproduction or use of such data.

Package Contents

The UW500 package contains the following items. Check the contents for missing items.

- **UW500 main unit**
- **Power adaptor (PA-3B)**
(The power adaptor may not be included in the package in some areas.)
- **CD-ROM**
- **USB cable (approx. 2m)**
- **Owner's manual (this book)**

About the included software

The included CD-ROM contains the following software.

- **USB-MIDI driver (YAMAHA USB-MIDI Driver)**

This driver enables the UW500's MIDI functions.

See page 22 for information on installing the driver.

- **XGworks lite V3.0A**

This sequence software supports Windows 98 and offers you an opportunity for high-quality music production. It lets you to create MIDI performance data and process audio data for advanced music post production.

To start the installer, double-click "Setup.exe" in the "XGworks_" folder. Install the software following the instructions on the display.

For more information on using the software, refer to the "XGworks Manual" PDF file after you finish the installation. This file is located at [Start|Programs|YAMAHA XGworks lite Ver.3.0]. Please note that the included Help and PDF files are for XGworks V3.0. The following functions are not available in XGworks lite V3.0A.

- Staff Window and Printing the Staves
- Drum Window
- Control Section
- Voice To Score R
- Auto Arranger
- Guitar Arranger
- Auto Play
- Importer
- SW1000XG Mixer
- Voice To Score
- XF Information Editor

Package Contents

- **Wave Editor TWE**

Wave Editor TWE is used to record and edit Wave files. It is suitable for loading and editing the Wave files recorded using XGworks.

This software is installed along with XGworks. To start the application, select [Wave Editor TWE] from the [Job] menu in XGworks. For more information on using the software, refer to the “Wave Editor TWE Manual” PDF file after you finish the installation. This file is located at [Start|Programs|YAMAHA XGworks lite Ver.3.0].

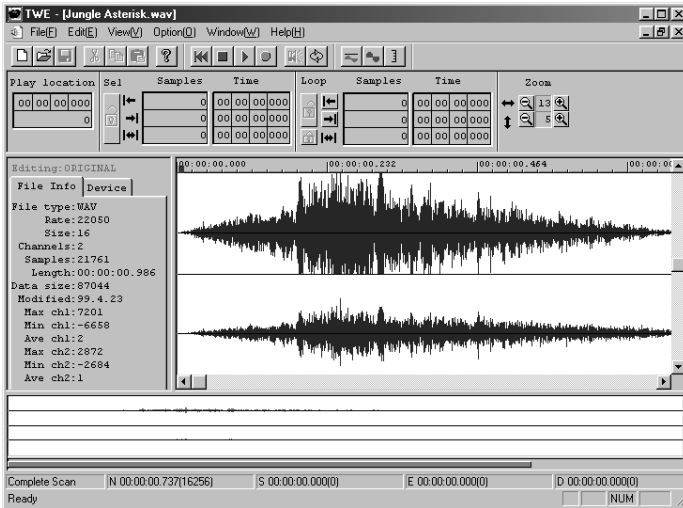

- **SoftSynthesizer (S-YXG50)**

The S-YXG50 is XG tone generator software that produces voices using the computer's CPU power. By installing SoftSynthesizer, you can enjoy high quality tones from MIDI data performance without connecting an external XG tone generator.

To start the installer, double-click “Setup.exe” in the “Syxg50_” folder. Install SoftSynthesizer according to the instructions on the display.

For more information on using the software, refer to the “S-YXG50 Help” file after you finish the installation. This file is located at [Start|Programs|YAMAHA SoftSynthesizer S-YXG50].

- **Acrobat Reader**

The Acrobat Reader allows you to view the electronic Owner's Manual saved in PDF format.

To start the installer, open the “English” folder in the “Acroread” folder, then double-click the “Ar40eng.exe.” Install the software according to the instructions on the display.

System Requirements

- OS: Windows 98 or Windows 98 Second Edition
Computer: USB-supported IBM-PC or compatible computer
CPU: Pentium 166MHz or higher (MMX Pentium 233 MHz or higher is recommended.)
Memory: 32MB or higher (64 MB or higher is recommended.)
Hard Disk: 2MB or more of free space

(NOTE) To use XGworks lite V3.0, 30MB or more of hard disk space is required. To use Wave files, much more space is required.

Parts and Functions

■ Front Panel

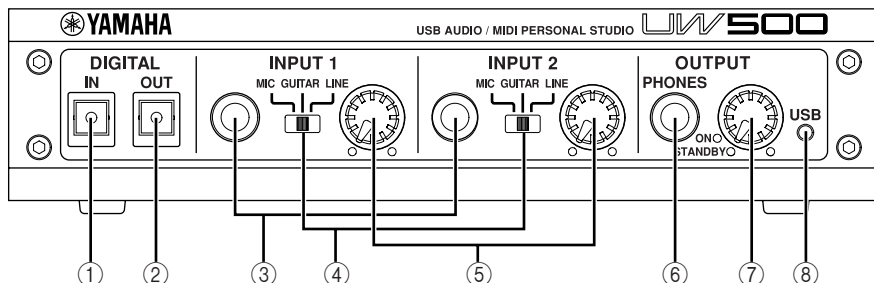

① DIGITAL IN jack

Digital signal is input here from an MD or CD player using an optical digital cable (with a square plug). Set the INPUT SELECT switch on the rear panel to "DIGITAL."

② DIGITAL OUT jack

This jack is used to record a digital signal from the computer to a digital recorder, such as an MD recorder. Use an optical digital cable (with a square plug) for connection.

(NOTE) Signals input at INPUT 1-3, AUX IN and DIGITAL IN cannot be route directly to the DIGITAL OUT jack.

③ INPUT 1/2 jacks

Audio signal is input here from a microphone, electric guitar, electric bass, electronic musical instrument, or CD player. Use a standard monaural plug cable for connection.

(NOTE) To use INPUT 1-3 jacks, set the INPUT SELECT switch on the rear panel to "STEREO" or "MONO."

④ INPUT 1/2 gain switches

These switches enable you to select a type of signal input at INPUT 1 and 2 jacks.

For stereo line input, set the gain switch to "LINE" and input the left signal to the INPUT 1 jack and the right signal to the INPUT 2 jack. Set the INPUT SELECT switch on the rear panel to "STEREO."

⑤ INPUT 1/2 volume knobs

These volume knobs enable you to adjust the volume level of the audio signal input at INPUT 1 and 2 jacks.

⑥ PHONES jack

Connect headphones with a standard jack here. Use the OUTPUT knob to adjust the headphone volume.

⑦ OUTPUT knob

This knob has two functions. It switches the power on and off (stand-by) each time a click sound is heard when you turn the knob

When the power is on, the knob enables you to adjust the UW500's overall volume. Note that the OUTPUT knob setting does not affect the output at the DIGITAL OUT jack and the input at the AUX IN jacks on the rear panel.



Even when the power is off (standby), a small current flows through the unit. If you plan not to use the UW500 for a long period of time, be sure to remove the power adaptor from the AC outlet.

⑧ USB LED

The LED lights up in red when the power is turned on to the UW500. It lights up in green when the computer is connected to the UW500 correctly. It flashes in green when the UW500 transmits or receives MIDI signal.

The LED lights up in orange if the INPUT SELECT switch is set to "TRACK DOWN" (page 15).

The LED flashes in orange if the sampling frequency of the signal input at the DIGITAL IN jack is not appropriate. In this case, select the correct frequency option in the application on the computer according to the sampling frequency of the input signal.

The LED flashes in red and green alternately when the copyrighted signal is input at the DIGITAL IN jack. The signal cannot be recorded on the computer (page 8).

Parts and Functions

■ Rear Panel

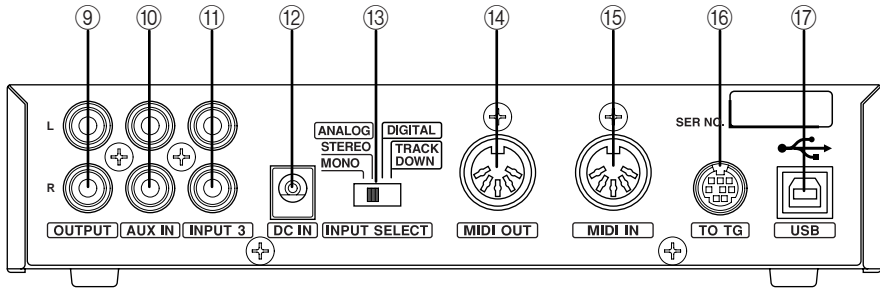

⑨ OUTPUT jacks

These jacks are used to connect a playback device, such as powered speakers, or a recording device, such as a tape recorder. Use RCA pin-plug cables for L and R connection.

⑩ AUX IN jacks

These jacks are used to connect an audio device, such as a CD player. The input signal is routed to the OUTPUT jacks and PHONES jack, bypassing the computer. (The signal is not routed to the DIGITAL OUT jack.) Use RCA pin-plug cables for L and R connection.

(NOTE) You cannot record an audio signal input from these jacks to the computer. To record audio to the computer, use the INPUT 3 jacks.

⑪ INPUT 3 jacks

These jacks are used to connect an audio device, such as a CD player. You can record audio signals input here to the computer. Use RCA pin-plug cables for L and R connection.

(NOTE) Even if the INPUT SELECT switch is set to "MONO," these jacks receive stereo signals.

⑫ DC IN jack

Connect the PA-3B power adaptor here.

⚠ Before connecting the power adaptor, make sure that the OUTPUT knob on the unit is set to standby (off). Connect the power adaptor to the DC IN jack, then plug the adaptor into the AC outlet.

⑬ INPUT SELECT switch

This switch enables you to select the input jacks (INPUT 1-3 or DIGITAL IN) and select the type of input signal.

To input stereo signals from an electronic musical instrument or audio device to INPUT 1-2 jacks (left signal to INPUT 1 and right signal to INPUT 2), set this switch to "STEREO." To input monaural signals from a microphone or electric guitar to INPUT 1 and 2 jacks, set the switch to "MONO." To input digital signals to the DIGITAL IN jack, set the switch to "DIGITAL."

(NOTE) You cannot use DIGITAL IN and INPUT 1-3 at the same time.

If you set this switch to “TRACK DOWN,” audio signals output from the USB terminal are sent back to the USB terminal unmodified. This setting is useful for tracking down multiple Wave files or audio signals from SoftSynthesizer into a single Wave file (page 39). In this case, the USB LED lights up in orange and the INPUT 1-3 jacks and DIGITAL IN jack are disabled.

⚠ With some application programs, input audio signals may be output unmodified. In this case, do not set the INPUT SELECT switch to “TRACK DOWN.” Otherwise, audio signals may oscillate, causing hearing loss or damage to the playback device.

⑭ MIDI IN terminal

This jack receives MIDI signals from a connected MIDI device. Use a MIDI cable to connect the MIDI OUT terminal of the MIDI device to this jack.

⑮ MIDI OUT terminal

This jack transmits MIDI signals to a connected MIDI device. Use a MIDI cable to connect the MIDI IN terminal of the MIDI device to this jack.

⑯ TO TG terminal

Connect this terminal to the TO HOST terminal on the MIDI devices. Use an optional 8-pin system peripheral cable for Apple Macintosh for connection.

(NOTE) Set the HOST SELECT switch of the connected MIDI device to “PC-1” or “Mac”, regardless of the computer you are using.

⑰ USB terminal

Connect this terminal to a computer’s USB terminal or a USB hub using a USB cable.

■ Audio Signal Flow

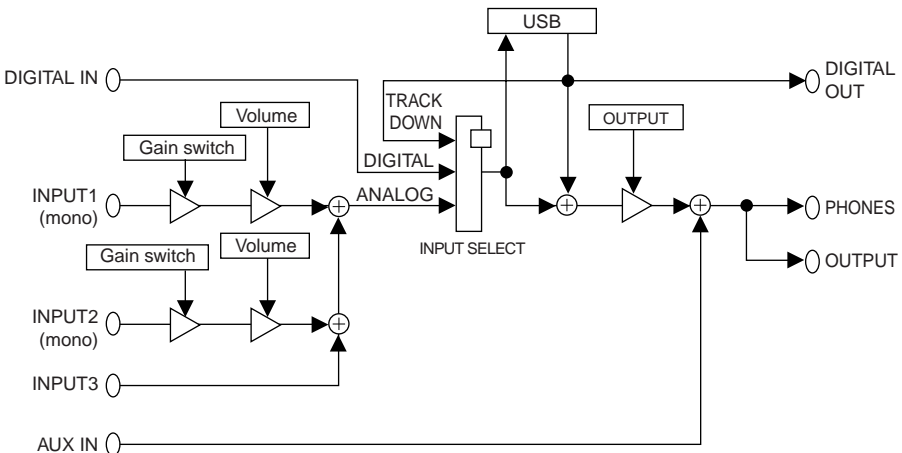

Connection

This section explains how to connect audio devices (such as a speaker or microphone) or MIDI devices (such as a tone generator or MIDI keyboard) to the UW500.

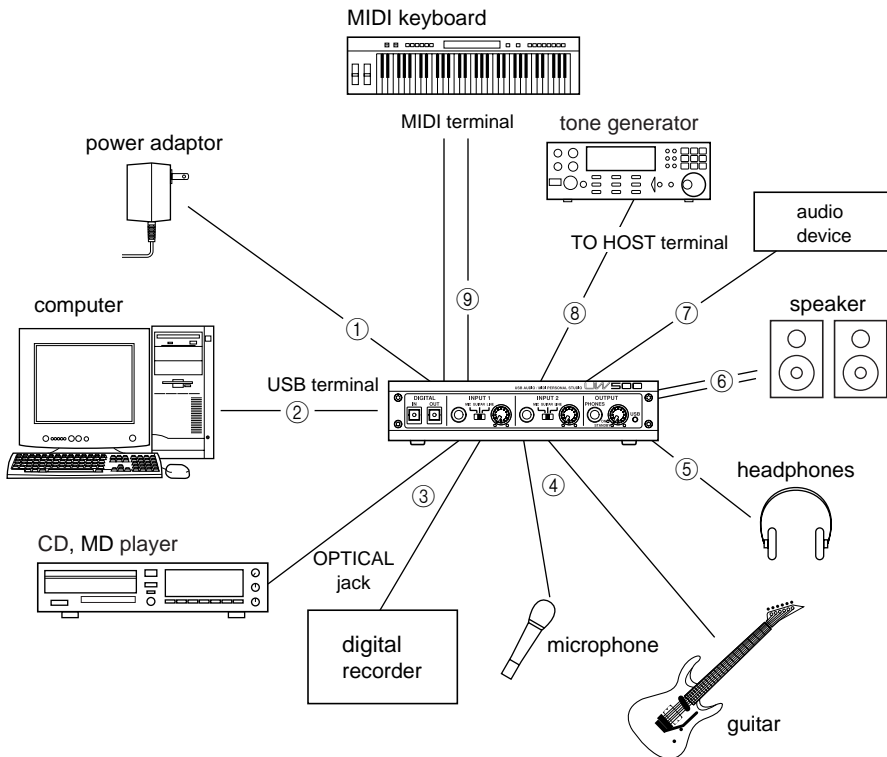

(1) Connecting the power adaptor

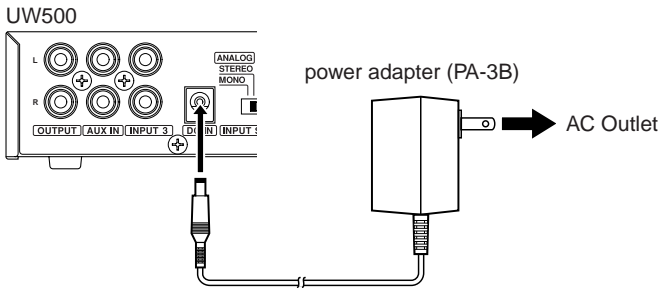

1. Set the OUTPUT knob on the UW500 to standby (off).
2. Connect the plug of the power adaptor (PA-3B) to the DC IN jack on the rear panel of the UW500.
3. Connect the power adaptor to the appropriate AC outlet.

⚠ Be sure to use the PA-3B power adaptor or equivalent recommended by YAMAHA. Using a power adaptor with different current, voltage, or polarity specifications may cause a malfunction. If you plan not to use the UW500 for a long period of time, be sure to remove the power adaptor from the AC outlet.

NOTE Before you turn on the power to the UW500, make sure that the computer and the UW500 are connected correctly.

(2) Connecting a computer

Connect the USB terminal of a computer to the USB terminal of the UW500 using a USB cable. Be sure to turn off the power to the UW500 before making the connection.

NOTE For this connection, you do not have to turn off the power to the computer.

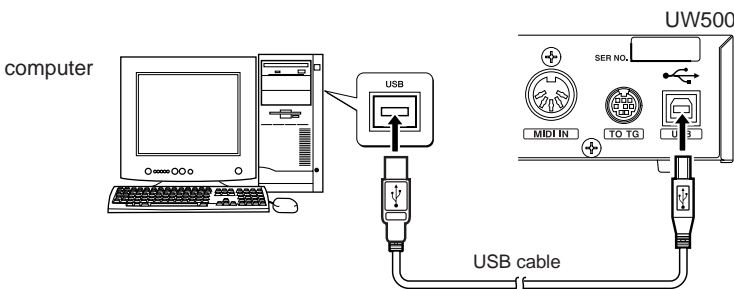

Connection

(3) Connecting a digital audio device

Connect a digital audio recording device to the DIGITAL OUT jack. Connect a digital audio playback device to the DIGITAL IN jack. Use optical digital cables (with square plugs) for connection.

(NOTE) Set the INPUT SELECT switch on the rear panel to “DIGITAL.”

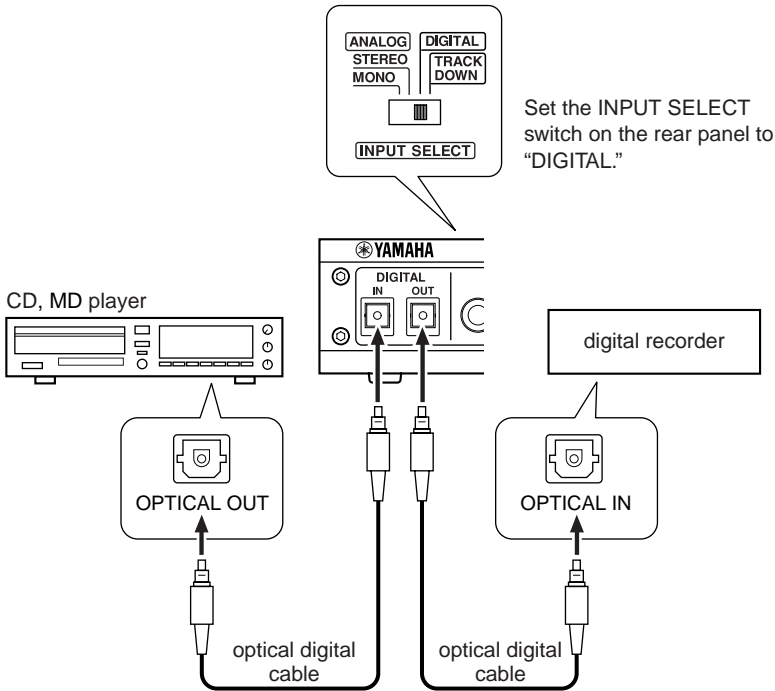

(4) Connecting an electric guitar or microphone

Connect an electric guitar, guitar effect, or microphone to INPUT 1 or 2. Set the gain switch for INPUT 1 or 2 to “GUITAR” or “MIC” and set the INPUT SELECT switch to “MONO.”

- ⚠ **Use caution when you set the gain switch. An inappropriate setting may damage your hearing or other audio devices.**
- ⚠ **Be sure to lower the INPUT 1 or 2 knob setting to minimum before connecting a cable to the INPUT 1 or 2 jack.**

NOTE Refer to page 34 for more information on the digital audio recording of guitar or other instruments.

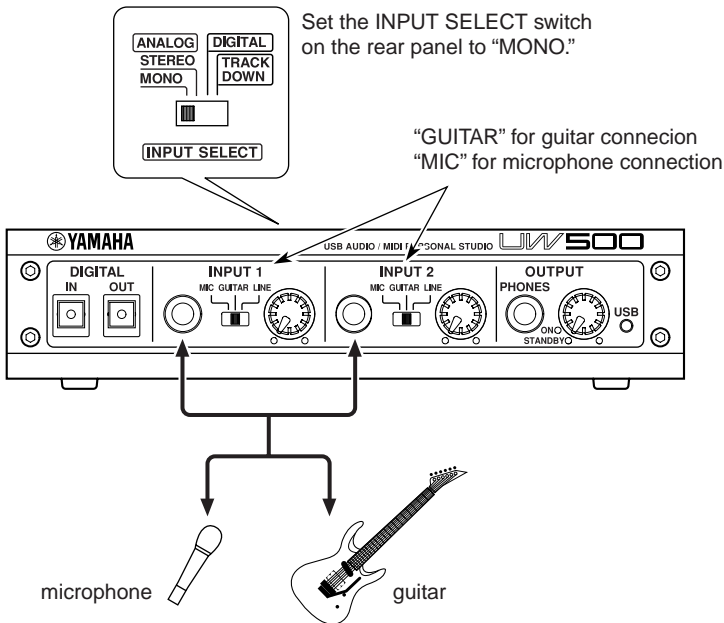

(5) Connecting headphones

Connect a standard stereo plug of your headphones to the PHONES jack of the UW500. Use the OUTPUT knob to adjust the headphone volume.

Connection

(6) Connecting speakers

Connect powered speakers to the UW500's OUTPUT jacks (RCA pin L/R jacks) using appropriate cables.

⚠ Before connecting speakers, be sure to turn off the speakers. Also, before turning the power to the UW500 and speakers on or off, lower the volume level of both units to minimum.

(7) Connecting an audio device

Connect an audio device, such as a CD player, to the INPUT 3 jacks (RCA pin L/R jacks) using an appropriate cable. Set the INPUT SELECT switch on the rear panel to "MONO" or "STEREO." If you wish to output signals from the OUTPUT jacks or PHONES jack, bypassing the computer, connect it to the AUX IN jacks.

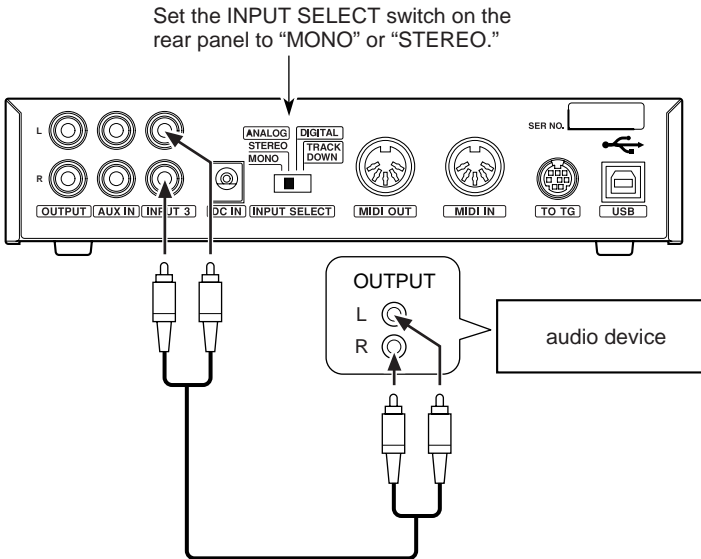

(8) Connecting the TO TG terminal to a MIDI device

Connect the TO HOST terminal of a MIDI device to the TO TG terminal of the UW500 using an optional serial cable (8-pin Macintosh Peripheral cable). At this time, set the HOST SELECT switch of the MIDI device to "PC-1" or "Mac", regardless of the computer you are using.

When you are using the TO TG terminal, you can use 5 MIDI OUT ports and 1 MIDI IN port to control the connected MIDI device.

NOTE See page 44 for more information on the relationship between the UW500's terminals and the port number.

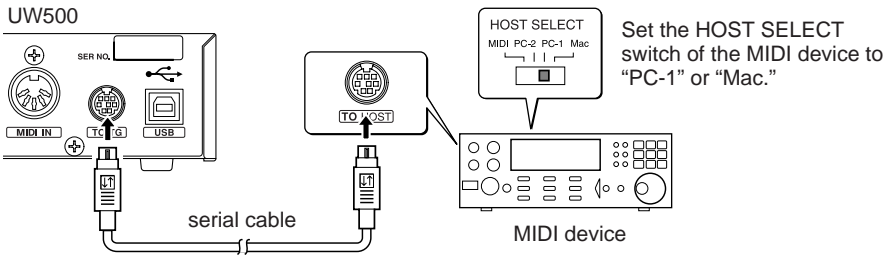

(9) Connecting the MIDI terminal to a MIDI device

Use optional MIDI cables to connect the MIDI IN terminal of the MIDI device to the MIDI OUT terminal of the UW500. Also, connect the MIDI OUT terminal of the MIDI device to the MIDI IN terminal of the UW500. At this time, set the HOST SELECT switch of the MIDI device to "MIDI."

NOTE See page 44 for more information on the relationship between the UW500's terminals and the port number.

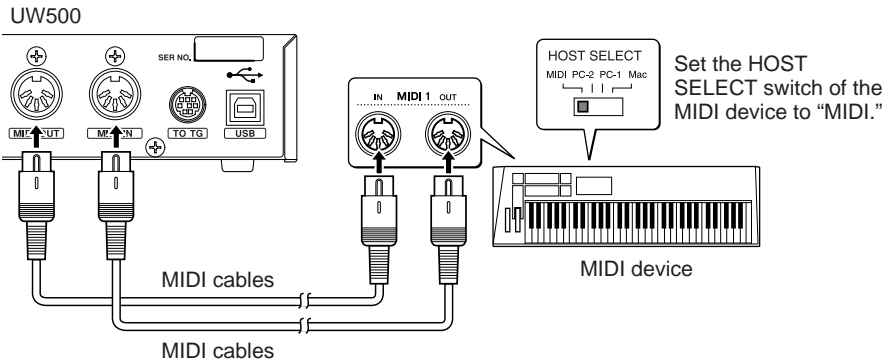

Installing the Driver

To operate the UW500, you need to install the driver on the computer correctly. USB-MIDI driver is software that transmits MIDI signals back and forth between sequence software and the UW500 via a USB cable. The USB audio driver is software that transmits and receives audio signals via a USB cable.

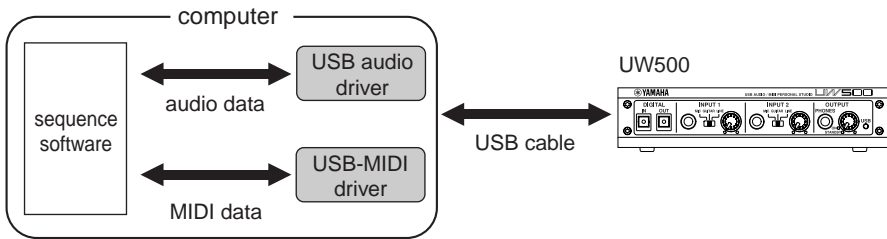

• Installation

Follow the steps below to install three drivers (USB Composite Device, USB-MIDI Driver, and USB Audio Device).

NOTE If you are using a USB device that has one or two of these drivers already installed, part of installation process may be automatically omitted. This is not a problem.

1. Start the computer.
2. Make sure that the power to the UW500 is turned off (standby). Connect the USB terminal of the computer or the USB hub to the USB terminal of the UW500 using the included USB cable.
3. Turn on the power to the UW500. The system displays the “Add New Hardware Wizard.”



Installing the Driver

4. Click **[Next]**. The system displays a screen that enables you to select search method.



5. Check the radio button to the left of **“Search for the best driver for your device. (Recommended)”**, and click **[Next]**. The system displays a screen that enables you to select a location in which to install the driver.



6. Insert the included CD-ROM into the CD-ROM drive. After making sure that the system recognizes the CD-ROM, check the **“Specify a location”** box and uncheck all other items. Click **[Browse]** and specify the **“USBdrv_”** folder on the CD-ROM drive (such as D:\USBdrv_). Click **[Next]**.

- When the system detects the driver and is ready for installation, it displays the following screen. Make sure that the “**USB Composite Device**” is listed, and click [**Next**].

The system starts installation.

NOTE The installation dialog may prompt you to insert the Windows 98 CD-ROM. In this case, insert the Windows 98 CD-ROM into the CD-ROM drive, specify an appropriate directory for the CD-ROM drive (such as “D:\Win98”), then continue the installation. The drive name and directory will vary depending on the computer.



- When installation is complete, the following screen appears. Click [**Finish**].

NOTE Some computers may take about ten seconds to show this screen after installation is complete.



Installing the Driver

9. “Add New Hardware Wizard” appears again in a while. Install “YAMAHA USB MIDI Driver” in the same manner as steps 3-8 described above.

NOTE The first screen indicates “YAMAHA UW500” or “Unknown device” as shown below.

NOTE The system may ask you to insert a Windows98 CD-ROM while it checks for the driver. Specify the “USBdrv_” folder of the included CD-ROM (such as D:\USBdrv_) and continue installation.



10. “Add New Hardware Wizard” appears again in a while. Install “USB Audio Device” in the same manner as steps 3-8 described above.



11. Restart the computer.

- NOTE** After installing the driver, wait for about ten seconds before restarting the computer and make sure that the computer is not accessing the hard disk and that the hour glass icon has changed back to the mouse pointer.

The driver has been installed.

• Checking the installation

Follow the steps below to make sure the driver has been installed correctly.

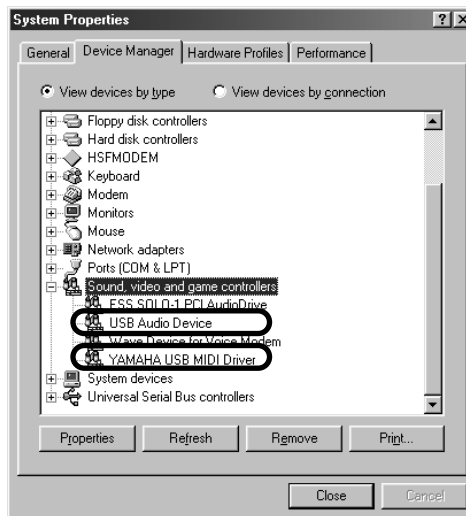

1. Double-click **“Control Panel”** in **“My Computer”** to open the Control Panel window, then double-click **“System”** to open the System Properties window.
2. Click the **“Device Manager”** tab and check to see if **“USB Audio Device”** and **“YAMAHA USB MIDI Driver”** are listed.

Installing the Driver

- **Specifying the output destination of audio and MIDI signals**

This section explains how to set up Windows 98 to use the UW500. For information on setting up your sequence software, refer to the owner's manual for the software.

Setup for audio playback and recording

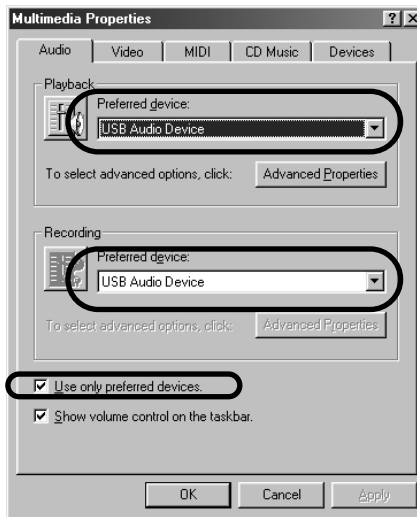

1. Double-click **"Multimedia"** in the **"Control Panel"** to open the Multimedia Properties window.
2. Click the **"Audio"** tab.
3. Click the **"Preferred device"** box in **"Playback"** and select **"USB Audio Device."**
 - (NOTE) "USB Audio Device (1)" may appear, depending on the computer. If two or more USB audio devices are connected, the corresponding number appears in parentheses.
4. Click the **"Preferred device"** box in **"Recording"** and select **"USB Audio Device."**
5. Check the **"Use only preferred devices"** checkbox and click [OK].

Setup for MIDI output

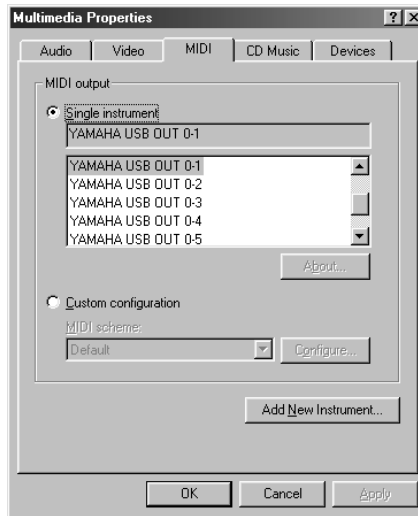

1. Double-click **"Multimedia"** in the **"Control Panel"** to open the Multimedia Properties window.
2. Click the **"MIDI"** tab and check to see if **"YAMAHA USB OUT xx-yy"** is listed.
(NOTE) "xx" means the device number (page 45) and "yy" means the port number (page 44). If only one Yamaha USB device is connected, the device number would be "0."
3. While **"Single instrument"** is selected, select a driver according to the port number of the connected tone generator, and click **[OK]**.

Installing the Driver

Setup for music CDs

Follow the steps below to play a music CD in the computer's CD-ROM drive and output the sound digitally from the UW500.

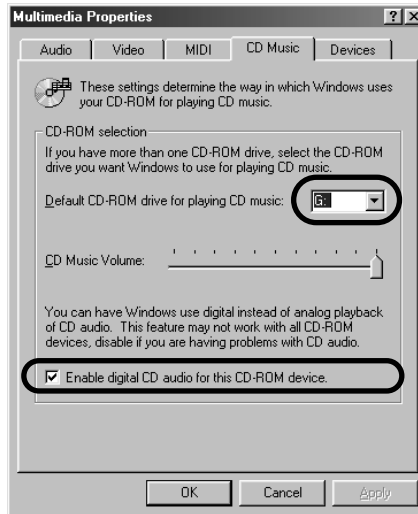

1. Double-click "Multimedia" in the "Control Panel" to open the Multimedia Properties window.
2. Click the "CD Music" tab
3. Make sure that the CD-ROM drive (e.g.: "D:") is selected correctly.
4. Check the "Enable digital CD audio for this CD-ROM device" checkbox and click [OK].

Setup for Volume Control

1. From the [Start] menu, select [Programs] → [Accessories] → [Entertainment] → [Volume Control] to open the "Volume Control" dialog.
2. Move the slider to adjust the volume level.

• Checking Wave file playback

Follow the steps below to check to see if you can hear a Wave file playback from the UW500.

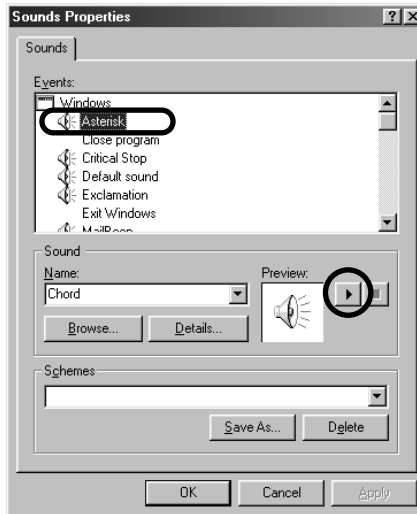

1. Double-click **“Sounds”** in **“Control Panel”** to open the Sounds window.
2. Select an item with a speaker icon, and click the play button to make sure that the playback sound is output from the headphones or speakers connected to the UW500.
3. Click **[OK]**.

Playing the Demo Song

This section explains how to play the demo song using the UW500, included sequence software “XGworks” and SoftSynthesizer “S-YXG50.”

NOTE For more information on using XGworks, refer to the included PDF manual.

“Unreal Wave”

Composed, Arranged & Programmed by Katsunori Ujiie (Idecs, Inc.)

E.Guitar: Isamu Tessy Teshima / E.Bass: Naoyuki Taro Irie / Vocal & Lyrics: ANTHONY F. SHOEMO

1. Connect the headphones to the PHONES jack (page 12) and powered speakers to the OUTPUT jacks (page 14).

 **Before connecting, be sure to lower the OUTPUT knob to minimum.**

2. Turn the OUTPUT knob to the ON position to turn on the power to the UW500.

 **Set the OUTPUT knob to the minimum position (just above the ON label).**

3. Start XGworks.

From the [Start] menu, select [Programs] → [YAMAHA XGworks lite Ver. 3.0] → [XGworks].

4. From the [Setup] menu, select [System Setup] to display the Device page of the system setup dialog.

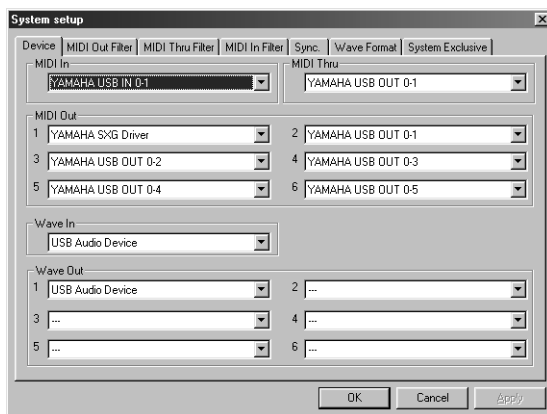

5. Click the [MIDI OUT 1] box to display the pop-up menu and select an appropriate device.
Select “YAMAHA SXG Driver” to use SoftSynthesizer. Select “YAMAHA USB OUT 0-1” to use an external MIDI sound source connected to the MIDI IN terminal. Select “YAMAHA USB OUT 0-2” to use an external MIDI sound source connected to the TO TG terminal.

Playing the Demo Song

(NOTE) If you are using a multi-port sound source connected to the TO TG terminal, you can select “YAMAHA USB OUT 3 - 6” to play multiple sound sources.

6. Select “**USB Audio Device**” for the [Wave In] and [Wave Out] boxes. Click [OK] to close the dialog box.
7. Copy the demo song from the included CD-ROM to your hard disk. To do so, insert the included CD-ROM into the CD-ROM drive and double-click the CD-ROM drive icon in “My Computer.” Drag the appropriate file (“UW500_dm.xws” for SoftSynthesizer, or “UW500_mu.xws” for external tone generator) in the “Demo” folder to the hard disk.

(NOTE) If you play the song using the SoftSynthesizer, select [Start] → [Programs] → [YAMAHA SoftSynthesizer S-YXG50] → [S-YXG50 Setup] → [Detailed Settings 1/2], then set the “WaveTable Polyphony” to 32, the “Maximum CPU Usage” to 40% and the “DirectSound” to Off.

8. Select [Open] from the [File] menu on the menu bar to display the dialog box for opening a file. Select the copied demo song and click [Open]. The system displays the demo song in the Track View window.

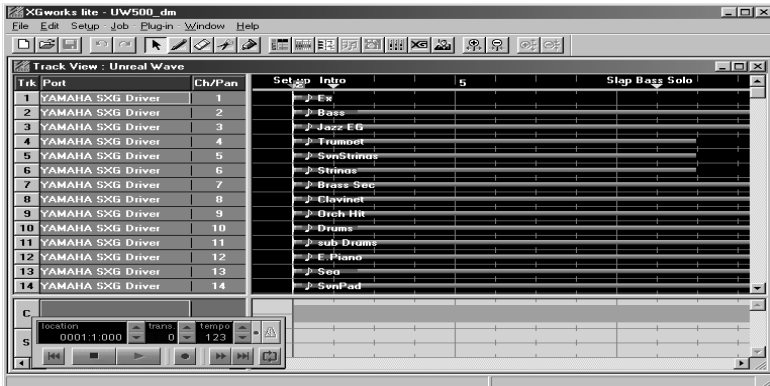

9. Click the Play button on the Play Control panel to start playback. Use the OUTPUT knob to adjust the volume level. To stop playback, click the Stop button.



Stop button Play button

(NOTE) If the demo song cannot be played back correctly, try to change the settings of SoftSynthesizer and quit unnecessary application programs.

Hard Disk Recording

You can record to hard disk using the UW500, the included sequence software (XGworks), and SoftSynthesizer (S-YXG50). The following section explains basic connections and procedures for recording guitar digitally to XGworks, then mastering it to a digital recorder (such as an MD recorder).

NOTE For more information on using XGworks, refer to the included PDF manual.

■ Recording guitar sounds digitally

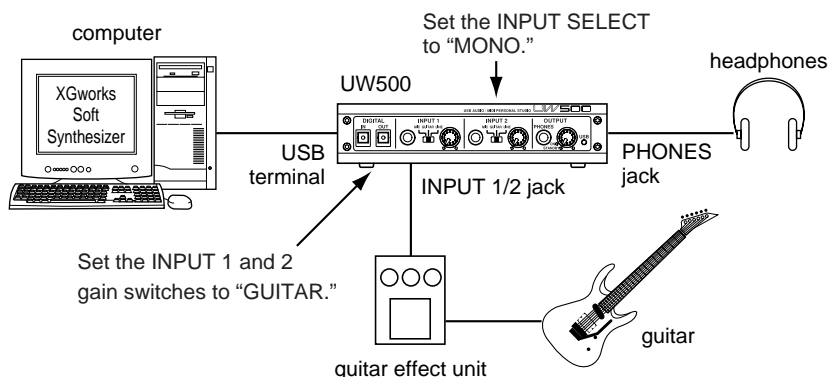

1. Connect the guitar or guitar effect unit to the INPUT 1 or 2 jack using a shielded guitar cable (with standard plugs). Connect the headphones to the PHONES jack (page 12), or the powered speakers to the OUTPUT jacks (page 14). If you are using an external MIDI tone generator, connect it to the UW500's MIDI OUT terminal or the TO TG terminal (page 21). Connect the UW500's AUX IN jacks to the OUTPUT jacks of the tone generator.

! Before connecting, be sure to turn off the power to the UW500.

NOTE If you wish to record your vocal and guitar accompaniment to separate files, connect the guitar and microphone to the INPUT 1 and 2 jacks and record them in stereo. Later, you can separate these into monaural Wave files using TWE.

2. Turn on the power to the UW500 by rotating the OUTPUT knob to the "ON" position.
! Lower the OUTPUT knob setting to minimum (just above the "ON" position).

- Set the INPUT 1 or 2 gain switch to “GUITAR” and set the INPUT SELECT switch on the rear panel to “MONO.”

NOTE If a stereo effect unit is connected to the INPUT 1 and 2 jacks, set the INPUT SELECT switch to “STEREO.”

- Start XGworks. From the **[File]** menu, select **[Open]** and open the recording file.

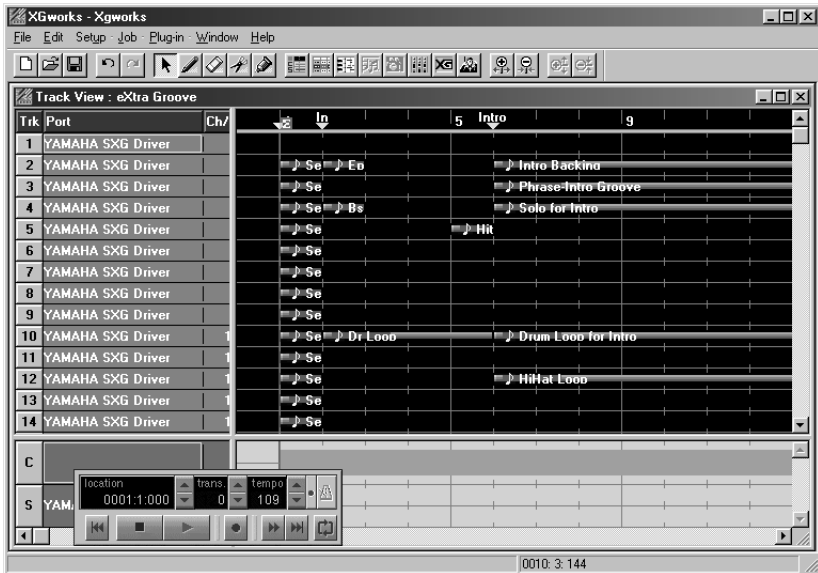

- From the **[Setup]** menu, select **[System Setup]**. In the Device page, select an appropriate device drivers.

NOTE For detailed Information, refer to step 5 on page 32.

Hard Disk Recording

- On the “Wave Format” page, click the box to display a drop-down list and select [44.1kHz, Mono, 16Bit]. Click [OK] to close the dialog box.

NOTE If a stereo effect unit is connected to the UW500 via stereo connection, select [44.1kHz, Stereo, 16Bit].

NOTE XGworks does not allow Wave files with different sampling frequencies to be played simultaneously.

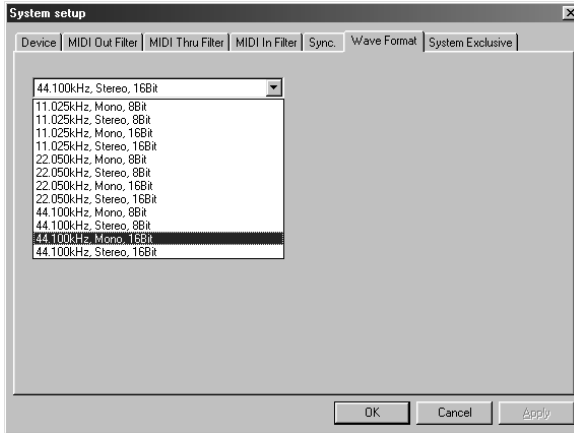

- From the [Setup] menu, select [Record/Playback Settings] and check the radio button on the left of “Realtime.” Click [OK] to close the window.

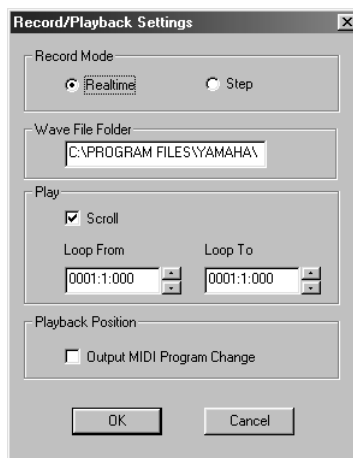

- On the Track View Window, click a cell in the “Type” column of the recording track to select “WAVE.” If you click a cell in the “Rec” column to place the corresponding track into record-ready status, an “R” mark appears in the “Rec” column. If you click the Record button in the Play Control panel, the button turns red, indicating that the track is in recording stand-by mode.

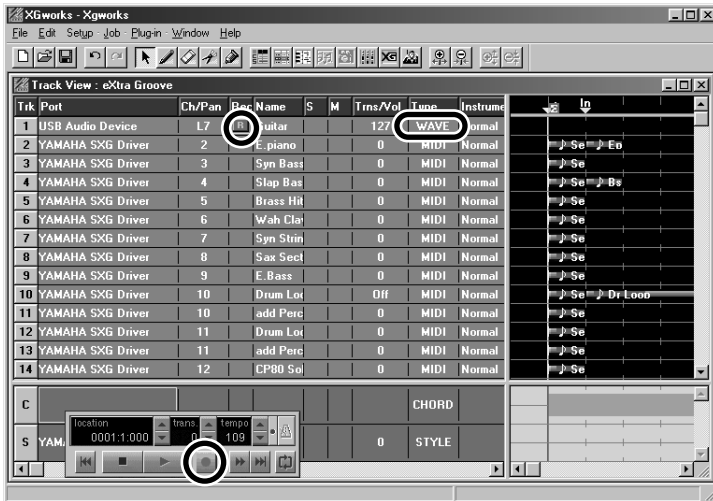

- Raise the guitar volume level, and while making sure that the sound through the headphones is not distorted, adjust the recording level using the INPUT 1/2 volume knobs. At the same time, use the OUTPUT knob to adjust the headphones volume level.

NOTE Set the volume levels to maximum in the “Volume Control” dialog box (page 30). Otherwise, the volume level of the recorded sound may be lower than the monitoring level.

- Click the Play button in the Play Control panel. The Play button lights up and recording starts. While listening to the SoftSynthesizer sound, play the guitar and record the sound.



Hard Disk Recording

11. Click the Stop button in the Play Control panel to stop recording.

NOTE To redo recording, click the undo button on the Tool bar to cancel the recording.



■ Mastering to an MD

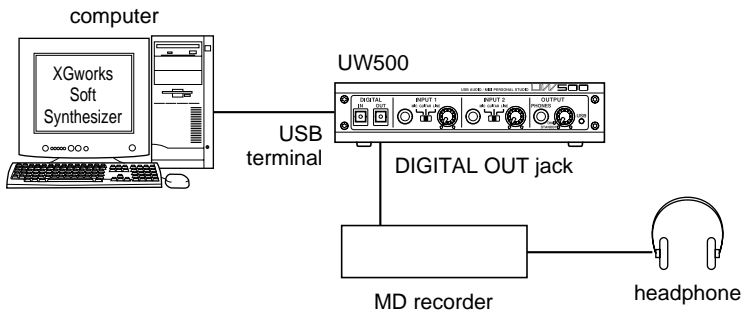

1. Connect an MD recorder to the UW500's DIGITAL OUT jack.

! Before making connections, be sure to turn off the power to the UW500.

NOTE Analog signals input at INPUT 1-3 or AUX IN cannot be route to the DIGITAL OUT jack. Therefore, if you wish to record the sound of an external MIDI tone generator, first you need to record the sound, as well as the guitar sound, to the hard disk.

2. Turn the OUTPUT knob to the ON position to turn on the power to the UW500.

! Set the OUTPUT knob to the minimum position (just above the ON label).

3. Start recording on the MD recorder, then click the Play button in the Play Control panel of XGworks to start playing back the song.

4. When the song ends, stop the MD recorder.

■ Tracking down on the computer

Using XGworks and the UW500, you can track down multiple Wave files or playback sounds from SoftSynthesizer into a single Wave file. The resultant Wave file can be converted into an MP3 file by using a third-party MP3 encoder, or recorded on a CD-R.

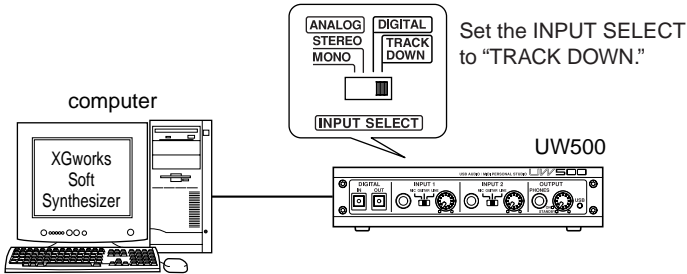

1. Set the INPUT SELECT switch on the rear panel to “TRACK DOWN.”
2. Click a cell in the “Type” column of the recording track to select “WAVE.” If you click a cell in the “Rec” column to place the corresponding track into record-ready status, an “R” mark appears in the “Rec” column. If you click the Record button in the Play Control panel, the button turns red, indicating that the track is in recording stand-by mode.
3. Click the Play button in the Play Control panel to start tracking down.

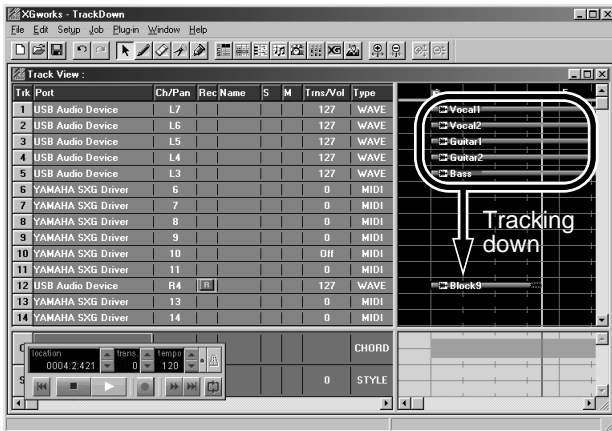

4. Click the Stop button, when the song ends. If you double-click the recorded Wave block, the information on the Wave block is displayed.

Creating a Song Using Sample Phrases

This section explains how to create an original song by editing included sample phrases (Wave data) in XGworks.

NOTE For more information on using XGworks, refer to the included PDF manual.

NOTE The song file and sample phrases are extracted from the demo song described on page 32.

1. Copy a song file and a collection of sample phrases from the included CD-ROM to your hard disk.
To do so, insert the included CD-ROM into the CD-ROM drive and double-click the CD-ROM drive icon in “My Computer.” Drag the “Tutorial” folder in the “Demo” folder to the hard disk.
2. Start XGworks.
NOTE For more information on the setup, refer to steps 1-6 in the “Playing the Demo Song” on page 32.
3. From the **[File]** menu on the menu bar, select **[Open]**. A dialog for opening files appears.

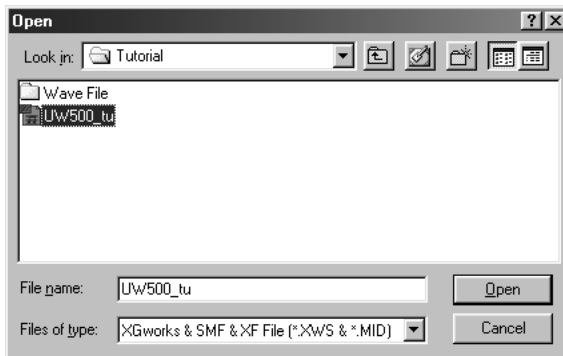

4. Select a song file “UW500_tu.xws” in the “Tutorial” folder and click **[Open]**. The Track View window displays the song.
NOTE This song file includes only MIDI data.

Creating a Song Using Sample Phrases

- On the Track View window, click a cell in the "Type" column of the tracks (tracks 17-19, into which you will load the Wave data) to select "WAVE."

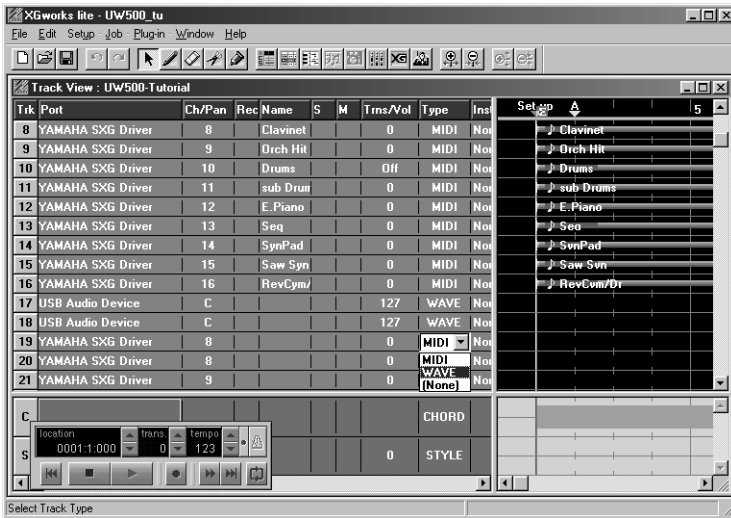

- Select the pencil tool icon from the tool bar.



Creating a Song Using Sample Phrases

7. Insert the Wave data for the bass part following the steps below. In the third measure on Track 17, press and hold down the left mouse button and drag the mouse to the right, then release the mouse button. A dialog used to open a file appears. Select "SlapBass.wav" in the "Wave File" folder and click [Open]. The Wave block appears in the Track View window.

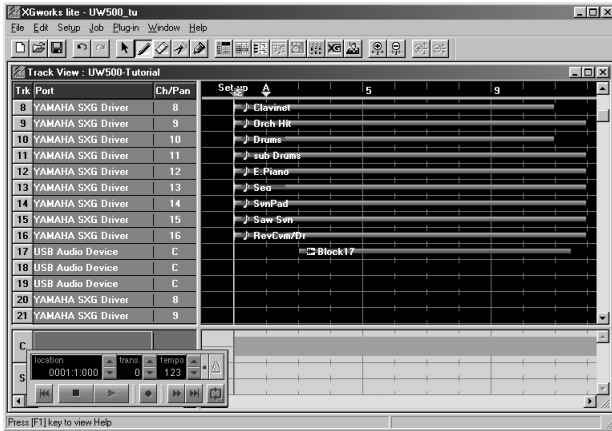

Double-click the inserted Wave block to open it in the List Window. Click the L1/L2/L3 (displays the location in Measure/Beat/Clock units) boxes, then set the location of the Wave file as follows: L1=0003, L2=01, L3=400.

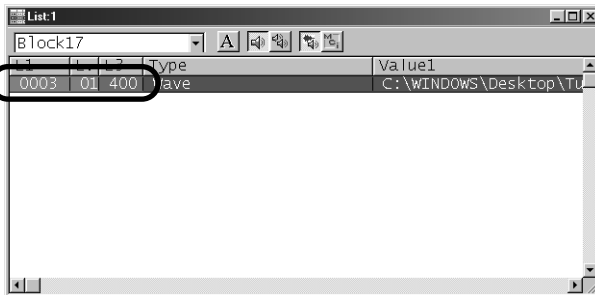

8. Insert the Wave data for the guitar part ("EGuitar.wav") into the third measure on Track 18 (as in step 7). Double-click the inserted Wave block, then set the location of the Wave file as follows: L1=0003, L2=01, L3=350.

Creating a Song Using Sample Phrases

9. Insert the Wave data for the vocal part (“RAP.wav”) into the second measure on Track 19 (as in step 7). Double-click the inserted Wave block, then set the location of the Wave file as follows: L1=0002, L2=02, L3=290.

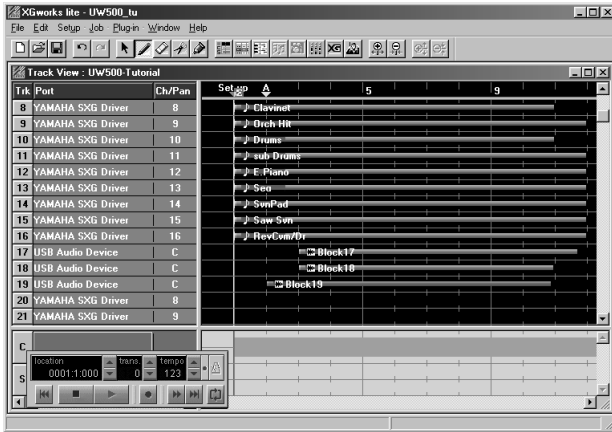

10. Click the Play button in the Play Control panel to start playing back the song. To stop the playback, click the Stop button.

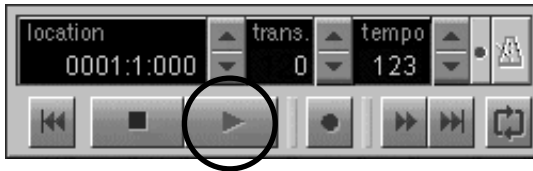

11. In the manner described above, you can select any other Wave files to create an original song.
Other Wave files are located in the “Additional Wave” folder contained in the “Demo” folder of the CD-ROM.
12. When your original song is complete, from the [File] menu select [Save As] to store the song file.

(NOTE) If you want to save the Wave data itself in the song file, save it using the “XGworks Original File with Wave (*.XWS)” format.

Changing the driver setting (MIDI Patch Screen)

You can change the assignment of I/O ports on the UW500 and port numbers selected from the computer.

Sequence software transmits and receives MIDI signals to and from the UW500 via the driver (page 22). The UW500 is equipped with MIDI IN/OUT terminals and a TO TG terminal. You specify the I/O ports of the UW500 to control from the computer's sequence software. At this time, changing the driver setting enables you to change these I/O assignments without re-patching the cables.

For example, you can transmit an identical MIDI signal to multiple ports or transmit layered MIDI signals from multiple ports to a single port. Also, you can directly route MIDI signals from MIDI IN to MIDI OUT.

The following table shows the assignment of the port numbers and I/O ports. With the default settings, the port number matches the computer's port number.

Port Number	MIDI Output terminal	MIDI Input terminal
Port 1	MIDI OUT	MIDI IN
Port 2	TO TG -A	TO TG
Port 3	TO TG -B	–
Port 4	TO TG -C	–
Port 5	TO TG -D	–
Port 6	TO TG -E	–

NOTE If a tone generator connected to the TO TG terminal does not support multi-port specifications, the selection of ports B-E will be ignored.

Changing the driver setting (MIDI Patch Screen)

- Starting the MIDI Patch screen

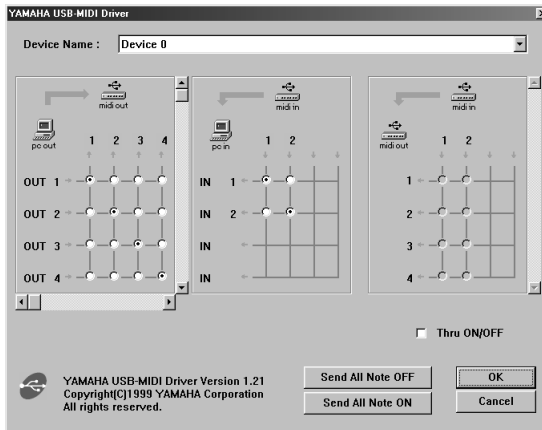

1. Double-click **“Control Panel”** in the **“My Computer”** folder.
2. Double-click **“MIDI-USB Driver”** to display the screen.

- Changing the device number

If multiple Yamaha USB devices are connected, you can change the device ID numbers, if necessary.

Click **“Device Name.”** The System displays the drop-down list. Select the device for which you wish to change the setting.

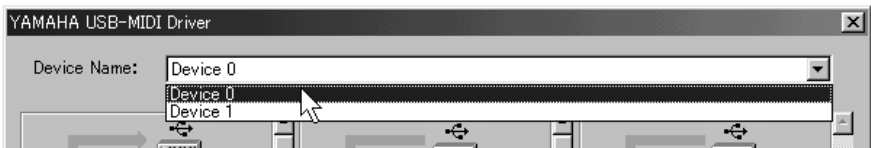

Changing the driver setting (MIDI Patch Screen)

- **Checking the signal path**

To see if the MIDI device is connected correctly, you can try transmitting MIDI signals.

Send All Note OFF

Send All Note ON

- **Note Off Message**

When you click [**Send All Note OFF**], a MIDI All Note Off message will be sent to all ports on the UW500.

- **Note On Message**

When you click [**Send All Note On**], a MIDI All Note On message will be sent to all ports on the UW500.

Changing the driver setting (MIDI Patch Screen)

- Changing the connection during playback (PC OUT → MIDI OUT)

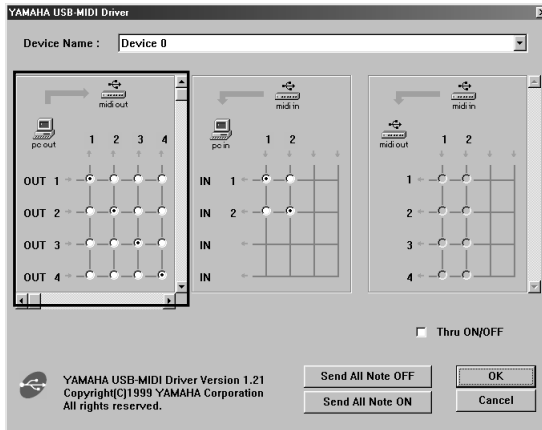

You can change the I/O assignment of the computer's output port and the UW500's output port. The left column shows the computer's output ports (OUT 1-6), and the top column shows the UW500's output ports (1-6). With the default settings, ports with the same number are connected to each other. However, you can change this setting by checking the check boxes.

If you check multiple check boxes vertically, MIDI signals from multiple output ports on the computer are merged and transmitted to one output port on the UW500. If you check multiple check boxes horizontally, a MIDI signal from one output port on the computer is distributed to multiple output ports on the UW500.

(NOTE) See page 44 for more information on the relationship between the UW500's I/O ports and the port numbers.

Routing MIDI signals from the computer's output ports 1 and 2 to MIDI OUT 1(MIDI OUT terminal) on the UW500

Check the check boxes as shown on the right, and click [OK] to enable the setting.

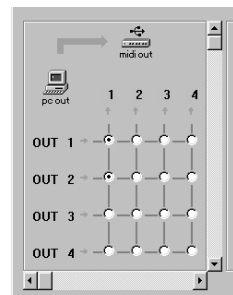

Changing the driver setting (MIDI Patch Screen)

- Changing the connection during recording (MIDI IN → PC IN)

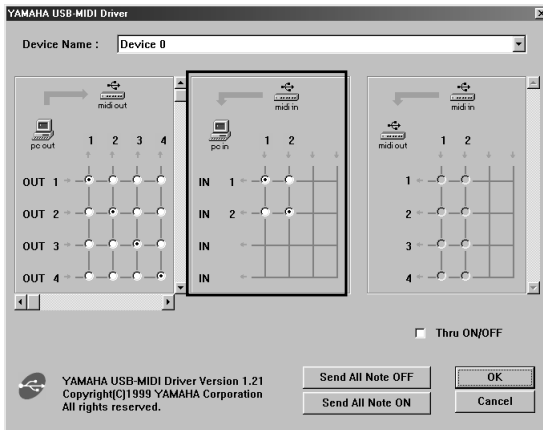

You can change the I/O assignment of the computer's input port and the UW500's input port. The left column shows the computer's input ports (IN 1-2), and the top column shows the UW500's input ports (1-2). With the default settings, ports with the same number are connected to each other. However, you can change this setting by checking the check boxes.

If you check multiple check boxes vertically, a MIDI signal from one input port on the UW500 is distributed to multiple input ports on the computer. If you check multiple check boxes horizontally, MIDI signals from multiple input ports on the UW500 are merged and transmitted to one input port on the computer.

(NOTE) See page 44 for more information on the relationship between the UW500's I/O ports and the port numbers.

Routing MIDI signals from MIDI IN 1 (MIDI IN terminal) and 2 (TO TG terminal) on the UW500 to the computer's input port 1

Check the check box as shown on the right, and click [OK] to enable the setting.

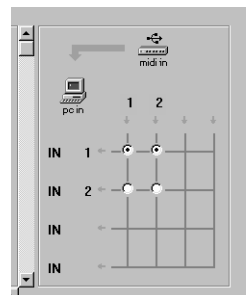

Changing the driver setting (MIDI Patch Screen)

- THRU output of MIDI signals (MIDI IN → MIDI OUT)

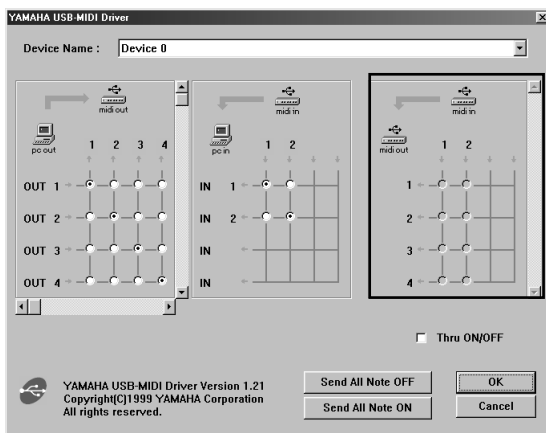

You can route MIDI signals received at the input port(s) of the UW500 directly to the output port(s) of the UW500 (this is called THRU output). This routing is useful when you wish to route MIDI signals from a MIDI keyboard directly to a tone generator. The left column shows the UW500's output ports (1-6), and the top column shows the UW500's input ports (1-2). To enable this function, check the **"Thru ON/OFF"** check box in the lower right corner of the screen.

If you check multiple check boxes vertically, a MIDI signal from one input port on the UW500 is distributed to multiple output ports on the UW500. If you check multiple check boxes horizontally, MIDI signals from multiple input ports on the UW500 are merged and transmitted to one output port on the UW500.

(NOTE) See page 44 for more information on the relationship between the UW500's I/O ports and the port numbers.

Routing MIDI signals directly from MIDI IN 1(MIDI IN terminal) to MIDI OUT 3(B port of TO TG terminal)

First check the **"Thru ON/OFF"** check box on the lower right corner of the screen. Then check the check box as shown on the right, and click **[OK]** to enable the setting.

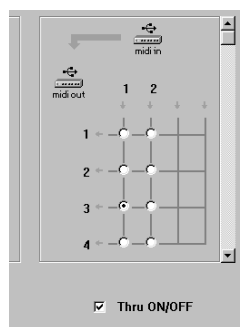

Specifications

Audio Capability:	One stereo- or mono-line recording One stereo-line Playback * Simultaneous recording and playback are possible.
ADA Conversions:	20-bit analog-to-digital conversion 20-bit digital-to-analog conversion Sampling Frequencies: 32 kHz, 44.1 kHz, 48 kHz
Jacks and Terminals:	Standard headphone jack Standard mic/guitar/line in jacks (x2) Digital in jack (for an optical square plug) Digital out jack (for an optical square plug) Line in jacks (RCA pin, L/R) AUX in jacks (RCA pin, L/R) Line out jacks (RCA pin, L/R) MIDI IN terminal (16 ch) MIDI OUT terminal (16 ch) TO TG terminal (MIDI outputs: 80 ch, MIDI inputs: 16 ch) USB terminal DC IN jack
Power Supply:	Power Adaptor (PA-3B)
Dimensions:	200(W) × 158(D) × 47(H) [mm]
Weight:	800g
Option:	8-pin Peripheral cable for Apple Macintosh Optical digital cable (with square plugs)

- Specifications and descriptions in this Owner's Manual are for information purposes only. Yamaha Corp. reserves the right to change or modify products or specifications at any time without prior notice. Since specifications, equipment or options may not be the same in every locale, please check with your Yamaha dealer.

Troubleshooting (FAQ)

■ The driver cannot be installed.

- **Is the USB cable connected correctly?**
 - Check the USB cable connection. (page 17)
 - Disconnect the USB cable, then connect it again.
- **Is the USB function enabled on your computer?**
 - When you connect the UW500 to the computer for the first time, if the “Add New Hardware Wizard” (page 23) does not appear, the USB function on the computer may be disabled. Perform the following steps.
 1. Double-click “**System**” in the “**Control Panel**” to open the System window.
 2. Click the “**Device Manager**” tab and make sure that no “!” or “x” marks appear at “**Universal serial bus controller**” or “**USB Root Hub**.”
If you see the “!” or “x” mark, the USB controller is disabled. For more information, refer to the owner’s manual of your computer.
- **Is any unknown device registered?**
 - If driver installation fails, the UW500 will be evaluated as an “Unknown device,” and you will not be able to install the driver. Delete the “Unknown device” by following the steps below.
 1. Double-click “**System**” in the “**Control Panel**” to open the System window.
 2. Click the “**Device Manager**” tab. With the “**View devices by type**” check box checked, look for “**Other devices**.”
 3. If you find “**Other devices**,” double-click it to extend the tree to look for “**Unknown device**.” If one appears, select it and click the [Remove] button.
 4. Remove the USB cable from the UW500, and make the connection again.
(NOTE) At this time, be sure to turn off the UW500.
 5. Install the driver by following the steps (starting from Step 3) described on page 23.

■ The UW500 does not operate correctly, or no sound is heard.

- **Did you install the driver? (page 23)**
- **Are the USB cable, MIDI cables, serial cables, and audio cables connected correctly? (page 16)**
- **Is the volume setting of the tone generator, playback device, and application program set to the appropriate level?**
- **Have you selected an appropriate port in the sequence software?**
- **Is the HOST SELECT switch on the tone generator set correctly?**
 - If the tone generator is connected to the MIDI IN/OUT terminals, set the switch to “MIDI.” If the tone generator is connected to the TO TG terminal, set the switch to “PC-1” or “Mac”, regardless of the computer you are using.

Troubleshooting (FAQ)

- **Are you using another USB device?**
 - If you are using another USB device, first connect only Yamaha's USB device to make sure there is no problem.
- **(You cannot play a music CD)**
 - Check the "Enable digital CD audio for this CD-ROM device" checkbox. (page 30).
- **(You do not hear any sound digitally input from a connected MD or CD player.)**
 - Is the INPUT SELECT switch set correctly? (page 14.)

■ The sound is interrupted or distorted.

- **Does your computer satisfy the system requirements? (page 11)**
- **Is any other application or device driver running?**
 - Quit all unnecessary application programs.
- **Have you tried to record and play back a Wave file at the same time?**
 - If you try to record and play back a Wave file at the same time, the playback sound may be interrupted and noise may be introduced, depending on the computer being used. When you are using XGworks, recording has priority.
- **Is the SoftSynthesizer set properly?**
 - If you are using SoftSynthesizer, the load can be reduced by changing the settings of "Maximum CPU Usage" and "Quality." For more information, refer to the "S-YXG50 Help" file located at [Start|Programs|YAMAHA SoftSynthesizer S-YXG50].
- **Have you tried to record or play audio data for several minutes?**
 - The processing performance of some computers may decline depending on various factors, such as the processing speed of audio data, access to an external storage device, etc. You may be able to improve the performance by changing the settings as follows:

[Control Panel] → [Multimedia] → [Audio] → [Advanced Properties].

Set the "Hardware acceleration" to "Full."

Set the "Sample rate conversion quality" to "Good."

[Control Panel] → [System] → [Device Manager] → [Disk Drives] or [Hard Disk Controllers]

Select a mode for high speed processing (for example, turn DMA mode ON).

Upgrade to a higher speed driver.

(NOTE) For more information on upgrading the driver, visit the web site of the hard disk manufacturer.

[Control Panel] → [System] → [Performance].

(NOTE) Yamaha recommends that only users with advanced knowledge about computers change this setting.

Make sure that the file system is correctly set. If the computer has enough free memory space (more than 128MB) and the size of the Wave file to be recorded or played back is not large, you may be able to improve the performance by changing the setting for the virtual memory.

Some computers may need updated device drivers (such as a hard disk controller) or BIOS. For more information, contact the customer support department or visit the home page of the computer manufacturer.

■ Cannot suspend or resume the computer correctly.

- Do not suspend the computer while the audio/MIDI application is running.

■ Wish to use the UW500 in MIDI-supported games.

1. Double-click "Multimedia" in the "Control Panel".
2. Click the "MIDI" tab and select the driver according to the port number of the connected tone generator. (page 29)

■ Wave data and MIDI data do not synchronize with each other on XGworks.

- MIDI data may not synchronize to Wave data on some computers. In this case, insert blank Wave data at the end of the XGworks song.
- Select [System Setup] from the [Setup] menu in XGworks to display the Device page. Do not select unnecessary devices here.

SOFTWARE LICENSING AGREEMENT

The following is a legal agreement between you, the end user, and Yamaha Corporation (“Yamaha”). The enclosed Yamaha software program is licensed by Yamaha to the original purchaser for use only on the terms set forth herein. Please read this licensing agreement with care. Opening this package indicates that you accept all terms outlined herein. If you do not agree to the terms, return this package unopened to Yamaha for a full refund.

1. GRANT OF LICENSE AND COPYRIGHT

Yamaha grants you, the original purchaser, the right to use one copy of the enclosed software program and data (“SOFTWARE”) on a single-user computer system. You may not use it on more than one computer or computer terminal. The SOFTWARE is owned by Yamaha and is protected by Japanese copyright laws and all applicable international treaty provisions. You are entitled to claim ownership of the media in which the SOFTWARE is included. Therefore, you must treat the SOFTWARE like any other copyrighted materials.

2. RESTRICTIONS

The SOFTWARE program is copyrighted. You may not engage in reverse engineering or reproduction of the SOFTWARE by other conceivable methods. You may not reproduce, modify, change, rent, lease, resell, or distribute the SOFTWARE in whole or in part, or create derivative works from the SOFTWARE. You may not transmit or network the SOFTWARE with other computers. You may transfer ownership of the SOFTWARE and the accompanying written materials on a permanent basis provided that you retain no copies and the recipient agrees to the terms of the licensing agreement.

3. TERMINATION

The licensing condition of the software program becomes effective on the day that you receive the SOFTWARE. If any one of the copyright laws or clauses of the licensing conditions is violated, the licensing agreement shall be terminated automatically without notice from Yamaha. In this case, you must destroy the licensed SOFTWARE and its copies immediately.

4. PRODUCT WARRANTY

Yamaha warrants to the original purchaser that if the SOFTWARE, when used in normal conditions, will not perform the functions described in the manual provided by Yamaha, the sole remedy will be that Yamaha will replace any media which proves defective in materials or workmanship on an exchange basis without charge. Except as expressly set forth above, the SOFTWARE is provided “as is,” and no other warranties, either expressed or implied, are made with respect to this software, including, without limitation the implied warranties of merchantability and fitness for a particular purpose.

5. LIMITED LIABILITY

Your sole remedies and Yamaha’s entire liability are as set forth above. In no event will Yamaha be liable to you or any other person for any damages, including without limitation any incidental or consequential damages, expenses, lost profits, lost savings or other damages arising out of the use or inability to use such SOFTWARE even if Yamaha or an authorized dealer has been advised of the possibility of such damages, or for any claim by any other party.

6. GENERAL

This license agreement shall be interpreted according to and governed by Japanese laws.



Yamaha Manual Library (English versions only)
<http://www2.yamaha.co.jp/manual/english/>

This document is printed on recycled chlorine free (ECF) paper with soy ink.
Auf Recycling-Umweltpapier gedruckt.
Ce document a été imprimé sur du papier recyclé non blanchi au chlore.

M.D.G., PA•DMI Division, Yamaha Corporation
© 2000 Yamaha Corporation

V657010 004AP AP5.2-01A0 Printed in Japan