

YAMAHA DSP-E492

Natural Sound AV Processor/Amplifier

Processeur/amplificateur audiovisuel "Son Naturel"

Thank you for selecting this YAMAHA AV Processor/Amplifier.

Nous vous remercions d'avoir porté votre choix sur ce processeur/amplificateur audiovisuel YAMAHA.

OWNER'S MANUAL

CONTENTS

Safety instructions	2
Caution	3
Supplied Accessories	4
Feauters	5
Notes about the Remote Control Transmitter	5
Profile of This Unit	6
Speaker Setup	7
Connections	8
Controls and Their Functions	15
Speaker Balance Adjustment	18
Basic Operations	20
Using Digital Sound Field Processor (DSP)	23
Troubleshooting	27
Specifications	28

MODE D'EMPLOI

TABLES DES MATIERES

Accessoires fournis	29
Caracteristiques	29
Attention	30
Remarques concernant la télécommande	31
Aperçu de cet appareil	32
Installation des enceintes acoustiques	33
Raccordements	34
Les commandes et leurs fonctions	41
Réglage de la balance des enceintes	44
Fonctionnement de base	46
Utilisation du processeur de champ sonore numérique (DSP)	49
En cas de difficulté	53
Caractéristiques techniques	54

SAFETY INSTRUCTIONS

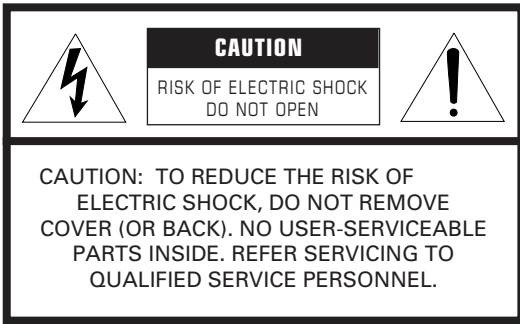

• Explanation of Graphical Symbols

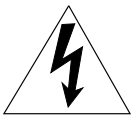

The lightning flash with arrowhead symbol, within an equilateral triangle, is intended to alert you to the presence of uninsulated "dangerous voltage" within the product's enclosure that may be of sufficient magnitude to constitute a risk of electric shock to persons.



The exclamation point within an equilateral triangle is intended to alert you to the presence of important operating and maintenance (servicing) instructions in the literature accompanying the appliance.



- 1 Read Instructions – All the safety and operating instructions should be read before the unit is operated.
- 2 Retain Instructions – The safety and operating instructions should be retained for future reference.
- 3 Heed Warnings – All warnings on the unit and in the operating instructions should be adhered to.
- 4 Follow Instructions – All operating and other instructions should be followed.
- 5 Water and Moisture – The unit should not be used near water – for example, near a bathtub, washbowl, kitchen sink, laundry tub, in a wet basement, or near a swimming pool, etc.
- 6 Carts and Stands – The unit should be used only with a cart or stand that is recommended by the manufacturer.
- 6A A unit and cart combination should be moved with care. Quick stops, excessive force, and uneven surfaces may cause the unit and cart combination to overturn.
- 7 Wall or Ceiling Mounting – The unit should be mounted to a wall or ceiling only as recommended by the manufacturer.
- 8 Ventilation – The unit should be situated so that its location or position does not interfere with its proper ventilation. For example, the unit should not be situated on a bed, sofa, rug, or similar surface, that may block the ventilation openings; or placed in a built-in installation, such as a bookcase or cabinet that may impede the flow of air through the ventilation openings.
- 9 Heat – The unit should be situated away from heat sources such as radiators, stoves, or other appliances that produce heat.
- 10 Power Sources – The unit should be connected to a power supply only of the type described in the operating instructions or as marked on the unit.
- 11 Power-Cord Protection – Power-supply cords should be routed so that they are not likely to be walked on or pinched by items placed upon or against them, paying particular attention to cords at plugs, convenience receptacles, and the point where they exit from the unit.
- 12 Cleaning – The unit should be cleaned only as recommended by the manufacturer.
- 13 Nonuse Periods – The power cord of the unit should be unplugged from the outlet when left unused for a long period of time.
- 14 Object and Liquid Entry – Care should be taken so that objects do not fall into and liquids are not spilled into the inside of the unit.
- 15 Damage Requiring Service – The unit should be serviced by qualified service personnel when:
 - A. The power-supply cord or the plug has been damaged; or
 - B. Objects have fallen, or liquid has been spilled into the unit; or
 - C. The unit has been exposed to rain; or
 - D. The unit does not appear to operate normally or exhibits a marked change in performance; or
 - E. The unit has been dropped, or the cabinet damaged.
- 16 Servicing – The user should not attempt to service the unit beyond those means described in the operating instructions. All other servicing should be referred to qualified service personnel.
- 17 Power Lines – An outdoor antenna should be located away from power lines.
- 18 Grounding or Polarization – Precautions should be taken so that the grounding or polarization is not defeated.



SPECIAL NOTES FOR FCC COMPOSITE DEVICE (for US customers only)

This device is a composite system. The digital device component may not cause harmful interference.

FCC INFORMATION (for US customers only)**1. IMPORTANT NOTICE : DO NOT MODIFY THIS UNIT!**

This product, when installed as indicated in the instructions contained in this manual, meets FCC requirements. Modifications not expressly approved by Yamaha may void your authority, granted by the FCC, to use the product.

2. IMPORTANT : When connecting this product to accessories and/or another product use only high quality shielded cables. Cable/s supplied with this product **MUST** be used. Follow all installation instructions. Failure to follow instructions could void your FCC authorization to use this product in the USA.**3. NOTE :** This product has been tested and found to comply with the requirements listed in FCC Regulations, Part 15 for Class "B" digital devices. Compliance with these requirements provides a reasonable level of assurance that your use of this product in a residential environment will not result in harmful interference with other electronic devices.

This equipment generates/uses radio frequencies and, if not installed and used according to the instructions found in the users manual, may cause interference harmful to the operation of other electronic devices.

Compliance with FCC regulations does not guarantee that interference will not occur in all installations. If this product is found to be the source of interference, which can be determined by turning the unit "OFF" and "ON", please try to eliminate the problem by using one of the following measures:

Relocate either this product or the device that is being affected by the interference.

Utilize power outlets that are on different branch (circuit breaker or fuse) circuits or install AC line filter/s.

In the case of radio or TV interference, relocate/reorient the antenna. If the antenna lead-in is 300 ohm ribbon lead, change the lead-in to coaxial type cable.

If these corrective measures do not produce satisfactory results, please contact the local retailer authorized to distribute this type of product. If you can not locate the appropriate retailer, please contact Yamaha Electronics Corp., U.S.A. 6660 Orangethorpe Ave, Buena Park, CA 90620.

The above statements apply **ONLY** to those products distributed by Yamaha Corporation of America or its subsidiaries.

We Want You Listening For A Lifetime (for US customers only)

YAMAHA and the Electronic Industries Association's Consumer Electronics Group want you to get the most out of your equipment by playing it at a safe level. One that lets the sound come through loud and clear without annoying blaring or distortion – and, most importantly, without affecting your sensitive hearing.

Since hearing damage from loud sounds is often undetectable until it is too late, YAMAHA and the Electronic Industries Association's Consumer Electronics Group recommend you to avoid prolonged exposure from excessive volume levels.

**CAUTION : READ THIS BEFORE OPERATING YOUR UNIT.**

- To assure the finest performance, please read this manual carefully. Keep it in a safe place for future reference.
- Install this unit in a cool, dry, clean place – away from windows, heat sources, sources of excessive vibration, dust, moisture and cold. Avoid sources of humming (transformers, motors). To prevent fire or electrical shock, do not expose the unit to rain or water.
- Never open the cabinet. If something drops into the set, contact your dealer.
- Do not use force on switches, controls or connection wires. When moving the unit, first disconnect the power plug and the wires connected to other equipment. Never pull the wires themselves.
- Always set the VOLUME control to "– ∞" before starting the audio source play. Increase the volume gradually to an appropriate level after playback has been started.
- Do not attempt to clean the unit with chemical solvents; this might damage the finish. Use a clean, dry cloth.
- The openings on the cabinet assure proper ventilation of the unit. If these openings are obstructed, the temperature inside the cabinet will rise rapidly. Therefore, avoid placing objects against these openings, and install the unit in well-ventilated condition. Make sure to allow a space of at least 20 cm behind, 20 cm on the both sides and 30 cm above the top panel of the unit. Otherwise it may not only damage the unit, but also cause fire.
- Be sure to read the "TROUBLESHOOTING" section regarding common operating errors before concluding that the unit is faulty.
- To prevent lightning damage, disconnect the AC power plug and disconnect the antenna cable when there is an electrical storm.
- AC outlet**
Do not connect audio equipment to the AC outlet on the rear panel if that equipment requires more power than the outlet is rated to provide.

IMPORTANT

Please record the serial number of this unit in the space below.

Serial No.:

The serial number is located on the rear of the unit. Retain this Owner's Manual in a safe place for future reference.

WARNING

TO REDUCE THE RISK OF FIRE OR ELECTRIC SHOCK, DO NOT EXPOSE THIS UNIT TO RAIN OR MOISTURE.

FOR CANADIAN CUSTOMERS

TO PREVENT ELECTRIC SHOCK, MATCH WIDE BLADE OF PLUG TO WIDE SLOT AND FULLY INSERT.

THIS CLASS B DIGITAL APPARATUS MEETS ALL REQUIREMENTS OF THE CANADIAN INTERFERENCE-CAUSING EQUIPMENT REGULATIONS.

The apparatus is not disconnected from the AC power source as long as it is connected to the wall outlet, even if the apparatus itself is turned off.

WARNING

Do not change the IMPEDANCE SELECTOR switch setting while the power to this unit is on, otherwise this unit may be damaged.

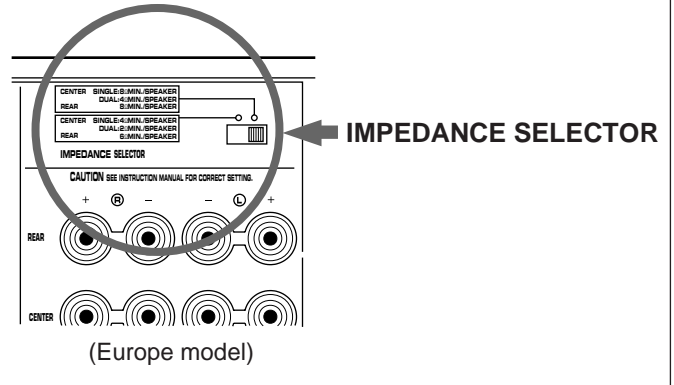

SUPPLIED ACCESSORIES

After unpacking, check that the following parts are included.

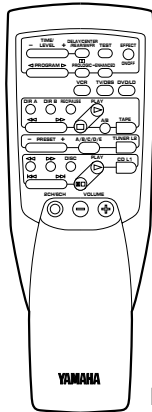

Remote Control Transmitter

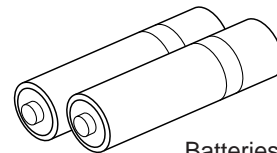

Batteries (size AA, R6, UM-3)

FEATURES

- **Center and Rear Channel Power Amplifier**
Center: 60W (8Ω) RMS Output Power, 0.04% THD, 20 – 20.000 Hz
Rear: 60W + 60W (8Ω) RMS Output Power, 0.04% THD, 20 – 20.000 Hz
- **Digital Sound Field Processor**
- **Dolby Pro Logic Surround Decoder**
- **Theater-like Sound Experience by the Combination of Dolby Pro Logic and YAMAHA DSP Technology (CINEMA DSP)**
- **Automatic Input Balance Control for Dolby Pro Logic Surround**
- **Test Tone Generator for Easier Speaker Balance Adjustment**
- **3 Center Channel Modes (NORMAL/WIDE/PHANTOM)**
- **Video Signal Input/Output Capability**
- **6-Channel Discrete Input Terminals for Connecting with a Dolby Digital (AC-3) Decoder**
- **6-Channel Input Terminals to Input Audio Signals from Your Existing Amplifier or Receiver**
- **Remote Control Capability**

NOTES ABOUT THE REMOTE CONTROL TRANSMITTER

Battery installation

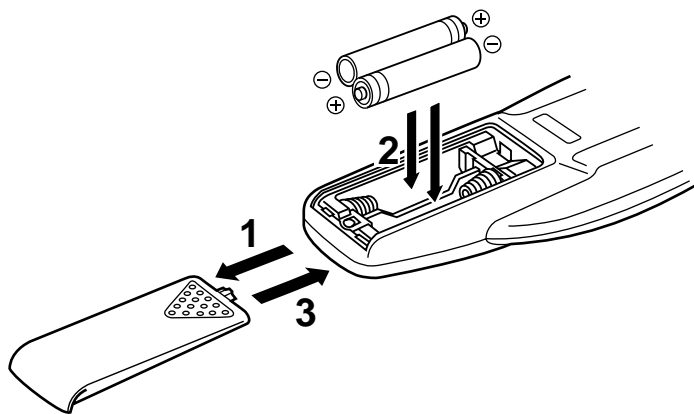

Battery replacement

If you find that the remote control transmitter must be used closer to the main unit, the batteries are weak. Replace both batteries with new ones.

Notes

- Use only AA, R6, UM-3 batteries for replacement.
- Be sure the polarities are correct. (See the illustration inside the battery compartment.)
- Remove the batteries if the remote control transmitter will not be used for an extended period of time.
- If batteries leak, dispose of them immediately. Avoid touching the leaked material or letting it come in contact with clothing, etc. Clean the battery compartment thoroughly before installing new batteries.

Remote control transmitter operation range

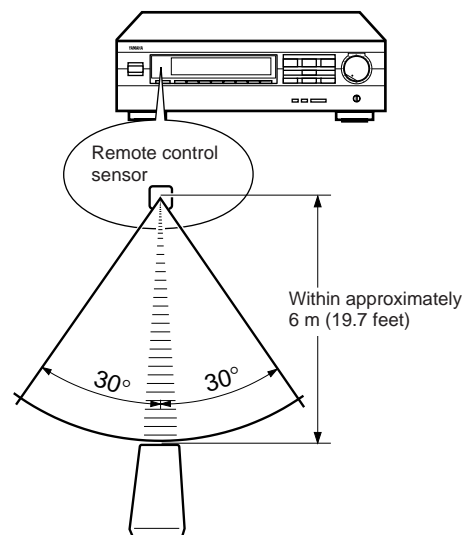

Notes

- There should be no large obstacles between the remote control transmitter and the main unit.
- If the remote control sensor is directly illuminated by strong lighting (especially an inverter type of fluorescent lamp etc.), it might cause the remote control transmitter not to work correctly. In this case, reposition the main unit to avoid direct lighting.

PROFILE OF THIS UNIT

You are the proud owner of a Yamaha AV processor/amplifier –an extremely sophisticated audio component. The Digital Sound Field Processor (DSP) built into this unit takes advantage of Yamaha's undisputed leadership in the field of digital audio processing to bring you a whole new world of listening experiences. Follow the instructions in this manual carefully when setting up your system, and this unit will sonically transform your room into a wide range of listening environments –movie theater, concert hall, and so on. In addition, you get incredible realism from sources encoded with Dolby Surround using the built-in Dolby Pro Logic Surround Decoder.

Please read this operation manual carefully and store it in a safe place for later reference.

Digital Sound Field Processing

What is it that makes live music so good? Today's advanced sound reproduction technology lets you get extremely close to the sound of a live performance, but chances are you'll still notice something missing: the acoustic environment of the live concert hall. Extensive research into the exact nature of the sonic reflections that create the ambience of a large hall has made it possible for Yamaha engineers to bring you this same sound in your own listening room, so you'll feel all the sound of a live concert.

Furthermore, our technicians, armed with sophisticated measuring equipment, have even made it possible to capture the acoustics of a variety of venues such as an actual concert hall, theater, etc. to allow you to accurately recreate one of several actual live performance environments, all in your own home.

Dolby Pro Logic Surround

This unit employs a Dolby Pro Logic Surround decoder similar to professional Dolby Stereo decoders used in many movie theaters. By using the Dolby Pro Logic Surround decoder, you can experience the dramatic realism and impact of Dolby Surround movie theater sound in your own home. Dolby Pro Logic employs a four channel five speaker system. The Pro Logic Surround system divides the input signal into four levels: the left and right main channels, the center channel (used for dialog), and the rear surround sound channels (used for sound effects, background noise, and other ambient noises). The center channel allows listeners seated in even less-than-ideal positions to hear the dialog originating from the action on the screen while experiencing good stereo imaging. Dolby Surround is encoded on the sound track of pre-recorded video tapes, laser discs, and some TV/cable broadcasts. When you play a source encoded with Dolby Surround on this unit, the Dolby Pro Logic Surround decoder decodes the signal and distributes the surround-sound effects.

This Dolby Pro Logic Surround Decoder employs a digital signal processing system. This system improves the stability of sound at each channel and minimizes crosstalk between channels, so that positioning of sounds around the room is more accurate compared with conventional analog signal processing systems. In addition, this unit features a built-in automatic input balance control. This always assures you the best performance without manual adjustment.

Manufactured under license from Dolby Laboratories Licensing Corporation. "Dolby", "AC-3", "Pro Logic", and the double-D symbol are trademarks of Dolby Laboratories Licensing Corporation.

Dolby Pro Logic Surround + DSP

Dolby Surround sound system shows its full ability in a large movie theater, because movie sounds are originally designed to be reproduced in a large movie theater using many speakers. It is difficult to create a sound environment similar to that of a movie theater in your listening room, because the room size, materials of inside walls, the number of speakers, etc. of your listening room is much different from those of a movie theater.

Yamaha DSP technology made it possible to present you with nearly the same sound experience as that of a large movie theater in your listening room by compensating for lack of presence and dynamics in your listening room with its original digital sound fields combined with Dolby Surround sound field.

The combination of Dolby Pro Logic Surround and DSP is used on the sound field program "  PRO LOGIC ENHANCED".

CINEMA DSP

The YAMAHA "CINEMA DSP" logo indicates these programs are created by the combination of Dolby Pro Logic and YAMAHA DSP technology.

SPEAKER SETUP

SPEAKERS TO BE USED

This unit is designed to provide the best sound-field quality with a 5-speaker configuration. The most effective speakers to use with this unit are main speakers, rear speakers and a center speaker. You may omit the center speaker. (Refer to the “**4-Speaker Configuration**” shown below.)

The main speakers are used for the main source sound plus the effect sounds. They will probably be the speakers from your present stereo system. The rear speakers are used for the effect and surround sounds, and the center speaker is for the center sounds (dialog etc.) within programs encoded with Dolby Surround. The center speaker needs to be equal in power to the main speakers, although the rear speakers should not be equal. However, all the speakers should have high enough power handling to accept the maximum output of this unit.

SPEAKER CONFIGURATION

5-Speaker Configuration

This configuration is the most effective and recommended one. In this configuration, the center speaker is necessary as well as the rear speakers. If the program **DOLBY PRO LOGIC** or **DOLBY PRO LOGIC ENHANCED** is selected, conversations will be output from the center speaker and the ambience will be excellent.

- Set the center channel mode to the “**NORMAL**” or “**WIDE**” position. (For details, refer to page 18.)

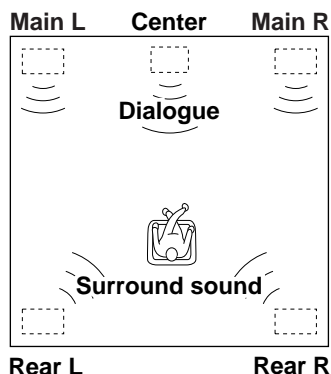

4-Speaker Configuration

The center speaker is not used in this configuration. If the program **DOLBY PRO LOGIC** or **DOLBY PRO LOGIC ENHANCED** is selected, the center sound is output from the left and the right main speakers. However, the sound effect of other programs can be the same as that of the 5-speaker configuration.

- Be sure to set the center channel mode to the “**PHANTOM**” position. (For details, refer to page 18.)

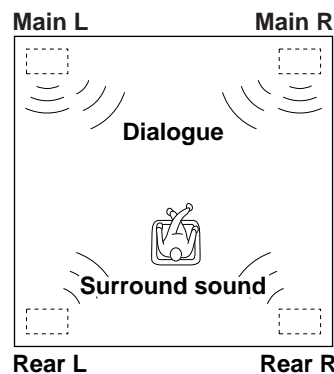

SPEAKER PLACEMENT

The recommended speaker configuration, the 5-speaker configuration, will require two speaker pairs: **main speakers** (your normal stereo speakers), and **rear speakers**, plus a **center speaker**. When you place these speakers, refer to the following.

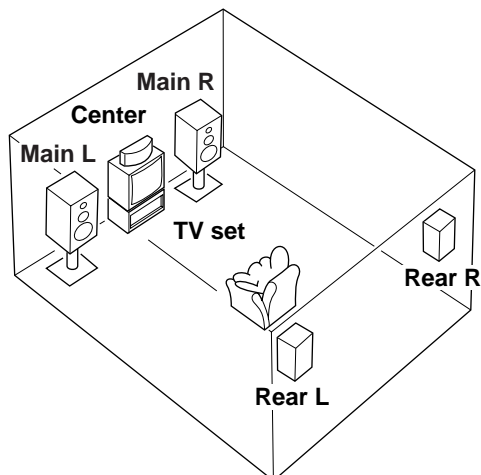

- Main:** In normal position. (The position of your present stereo speaker system.)
- Rear:** Behind your listening position, facing slightly inward. Nearly six feet (approx. 1.8 m) up from the floor.
- Center:** Precisely between the main speakers. (To avoid interference with TV sets, use a magnetically shielded speaker.)

CONNECTIONS

REAR PANEL PARTS AND THEIR FUNCTIONS

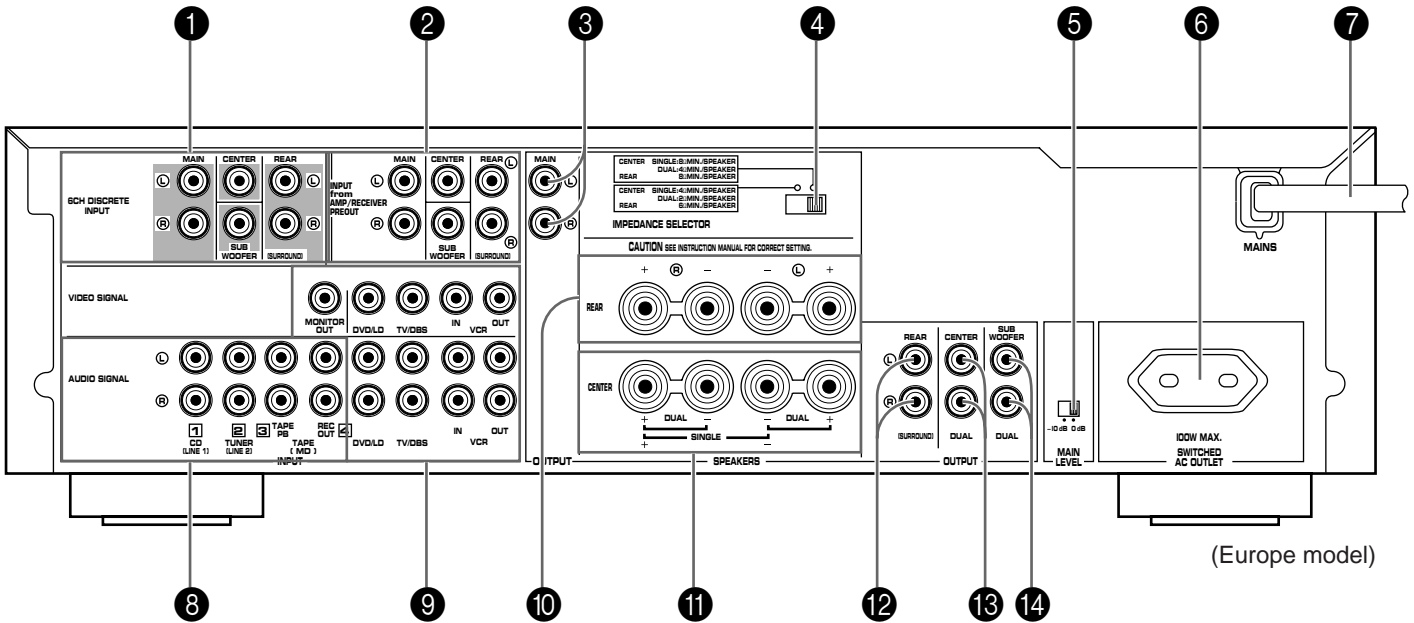

1 6CH DISCRETE INPUT terminals

Connect a Dolby Digital (AC-3) Decoder to these terminals. 6-channels (left main, right main, center, left rear surround, right rear surround and subwoofer) of discrete audio signals with the Dolby Digital (AC-3) decoded are input to these terminals from the decoder.

2 INPUT (from AMP/RECEIVER PREOUT) terminals

These are additional 6-channel audio signal input terminals (for left main, right main, center, left rear surround, right rear surround and subwoofer channels) available for inputting signals from your existing amplifier, receiver, sound processor, etc. to this unit.

To listen to a sound by reproducing signals input to these terminals from the external amplifier etc., be sure to set the **PROCESSOR SELECTOR** switch on the front panel to the "EXTERNAL" position. By doing so, the signals input to these terminals are sent to the corresponding SPEAKERS terminals and OUTPUT terminals of this unit bypassing any circuit in this unit. So, volume, tone, etc. must be controlled on the external amplifier.

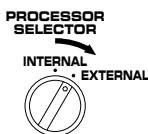

3 MAIN OUTPUT terminals

Main-channel line output. Connect these to input terminals of external stereo power amplifier (MAIN IN or equivalent terminals of integrated amplifier or receiver) driving the main speakers.

4 IMPEDANCE SELECTOR switch

Select the position whose requirements your speaker system meets. Be sure to switch this only when the power of this unit is turned off.

 (Right position)

Center: If you use one center speaker, the impedance of the speaker must be 8Ω or higher. If you use two center speakers, the impedance of each speaker must be 4Ω or higher.

Rear: The impedance of each speaker must be 8Ω or higher.

 (Left position)

Center: If you use one center speaker, the impedance of the speaker must be 4Ω or higher. If you use two center speakers, the impedance of each speaker must be 2Ω or higher.

Rear: The impedance of each speaker must be 6Ω or higher.

WARNING

Do not change the IMPEDANCE SELECTOR switch setting while the power to this unit is on, otherwise this unit may be damaged.

5 MAIN LEVEL switch <U.K. and Europe models only>
Normally set to "0 dB". If desired, you can decrease the output level at the MAIN OUTPUT terminals by 10 dB by setting this switch to "-10 dB".

6 AC OUTLET (UNSWITCHED)

The power cord of any audio/video unit can be connected to this outlet.

The power to this outlet is not controlled by this unit's **POWER** switch. This outlet will supply power to the connected unit even if this unit is turned off.

The maximum power that can be connected to this outlet is 100 watts.

7 AC power cord

After all connections are completed, connect this into a wall AC outlet.

8 AUDIO SIGNAL connection terminals (for audio source equipment)

Connect the inputs and/or outputs of your audio equipment.

9 AUDIO/VIDEO SIGNAL connection terminals (for video source equipment)

Connect the audio and video inputs and/or outputs of your video equipment.

10 REAR SPEAKERS terminals

When using the built-in rear-channel amplifier, connect the rear speakers here.

11 CENTER SPEAKERS terminals

When using the built-in center-channel amplifier, connect one or two center speakers here.

12 REAR (SURROUND) OUTPUT terminals

These terminals are for rear channel line output. There is no connection to these terminals when you use the built-in amplifier.

However, if you drive rear speakers with an external stereo power amplifier, connect the input terminals of the external amplifier (MAIN IN or AUX terminals of a power amplifier or an integrated amplifier) to these terminals.

Note

Output level of signals from the MAIN, REAR, CENTER and SUBWOOFER OUTPUT terminals are adjusted by the use of **VOLUME** control on the front panel or **VOLUME** keys on the remote control transmitter.

13 CENTER OUTPUT terminals

These terminals are for center channel line output. There is no connection to these terminals when you use the built-in amplifier.

However, if you drive a center speaker with an external power amplifier, connect the input terminal of the external amplifier driving a center speaker to one of these terminals.

If you drive two center speakers with external amplifiers, connect the input terminal of the external amplifier driving another center speaker to the other terminal.

14 SUBWOOFER OUTPUT terminals

You may wish to add a subwoofer to reinforce the bass frequencies.

These terminals are line level outputs for connecting with the amplifier(s) driving subwoofer(s).

When the input signals to this unit are in normal 2-channel stereo, these terminals output only frequencies below 150 Hz (200 Hz for General model only) from the main and center channels. When signals decoded with the Dolby Digital (AC-3) are input to this unit and are selected as the input source, these terminals output signals from the subwoofer channel.

EXAMPLES OF BASIC CONNECTIONS

Never plug in this unit and other components until all connections are completed.

Note

When making connections between this unit and other components, be sure all connections are made correctly, that is to say L (left) to L, R (right) to R, “+” to “+” and “-” to “-”. Also, refer to the owner’s manual for each component to be connected to this unit.

* If you have YAMAHA components numbered as 1, 2, 3, etc. on the rear panel, connections can be made easily by making sure to connect the output (or input) terminals of each component to the same-numbered terminals of this unit.

1 When this unit is used as a main controller

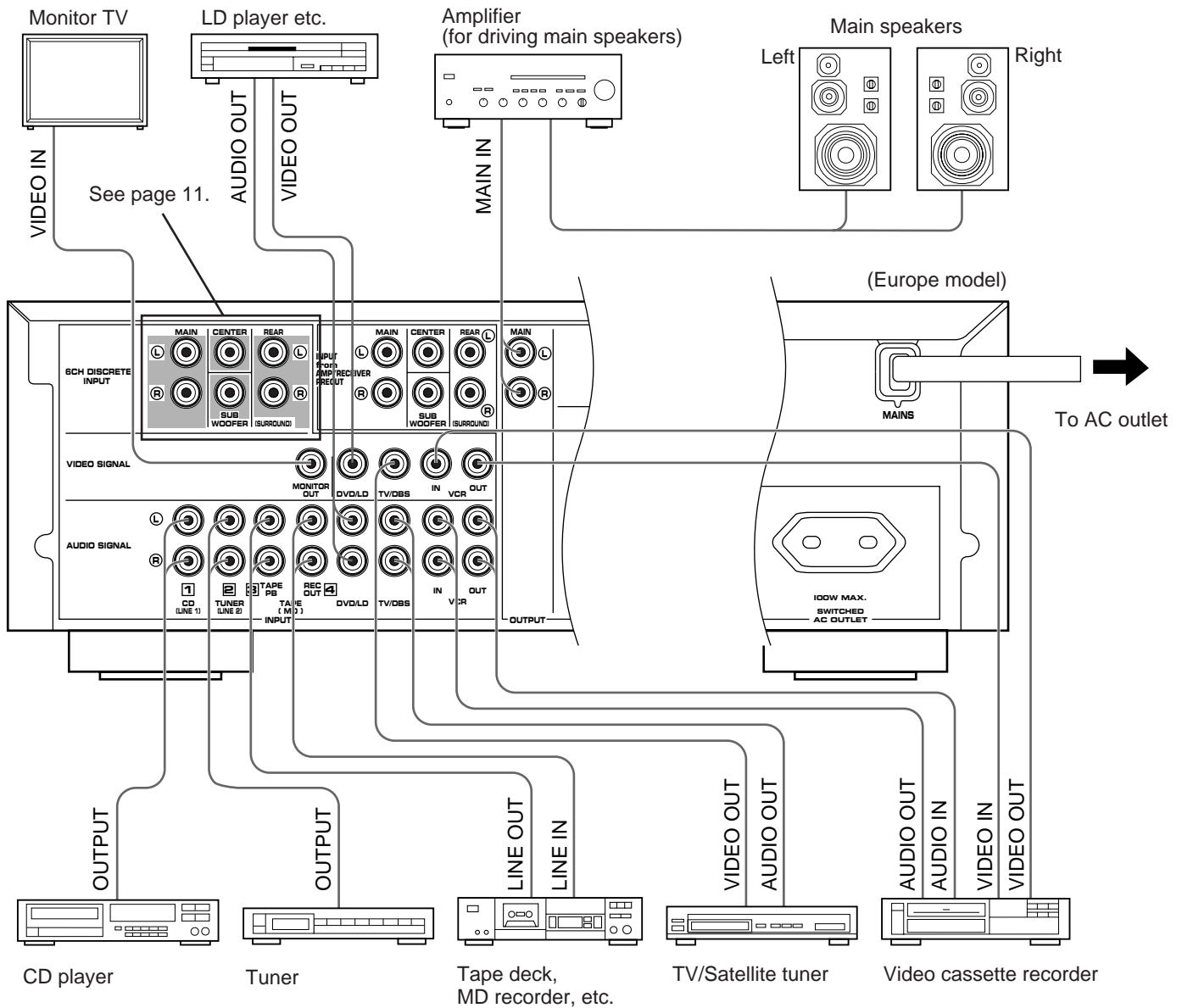

Notes

- If you select this connecting way, the **PROCESSOR SELECTOR** switch on the front panel of this unit must be set to the “INTERNAL” position.
- For speaker connections, see page 12 – 13.

Connecting with a Dolby Digital (AC-3) Decoder

If you have a Dolby Digital (AC-3) Decoder unit or an LD player etc. which incorporates a Dolby Digital (AC-3) Decoder, its discrete outputs can be connected to this unit.

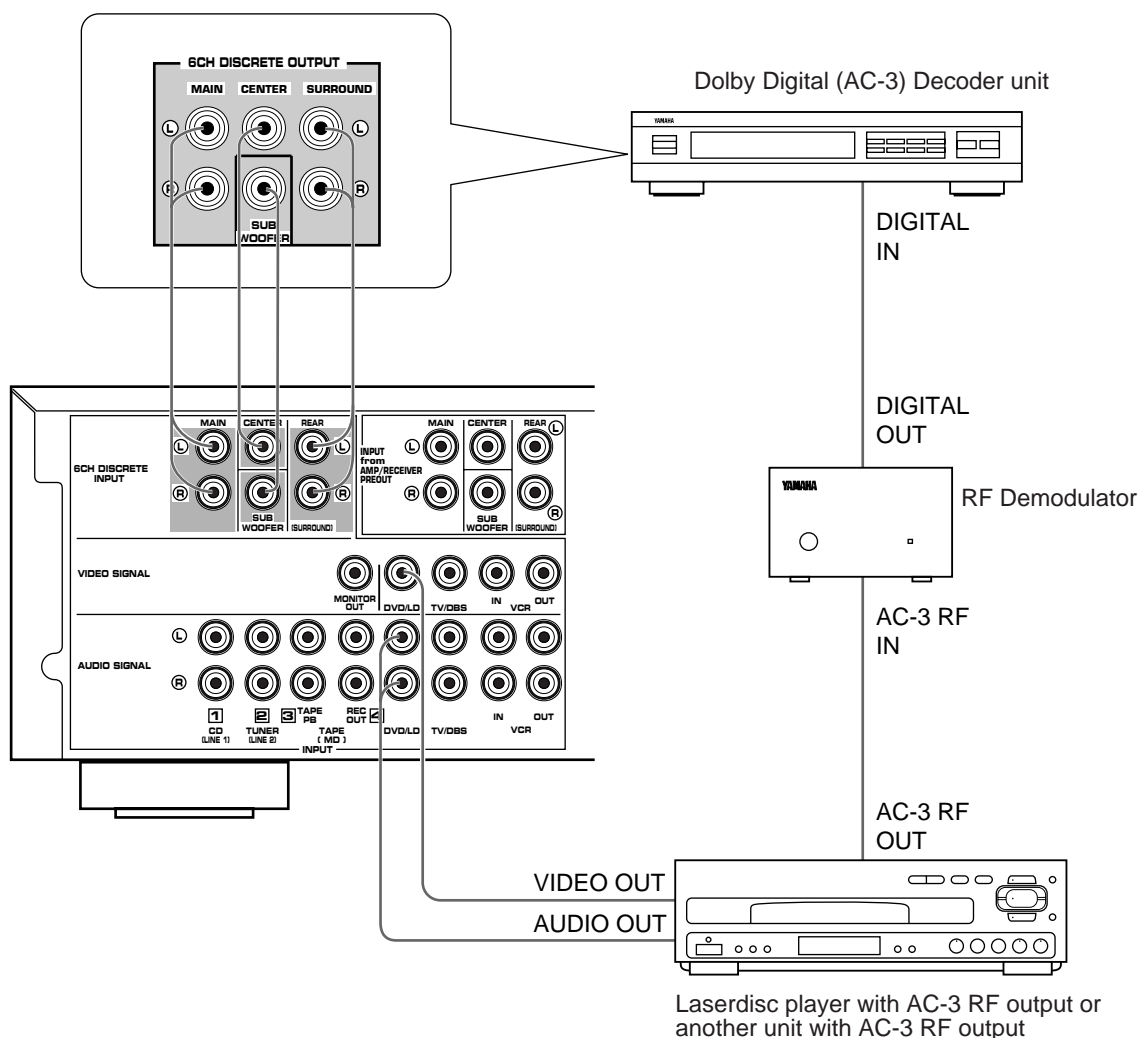

Notes

- The laserdisc player (or another unit) must be also connected to the DVD/LD (or TV/DBS) AUDIO SIGNAL INPUT terminals of this unit for playing a source with the Dolby Pro Logic Surround decoded or in normal stereo (or monaural).
- The discrete signals input to this unit cannot be recorded by a tape deck, MD recorder or VCR. To record a source played on the laserdisc player (or another unit), it must be connected to the DVD/LD (or TV/DBS) AUDIO/VIDEO SIGNAL INPUT terminals of this unit.
- If you made no connection to the SUBWOOFER input terminal of this unit or you will not use a subwoofer, you should make a setting for distributing signals at the LFE channel to the right and left MAIN output terminals on the Dolby Digital (AC-3) Decoder unit. (For details, refer to the owner's manual for the Dolby Digital (AC-3) Decoder unit.

CONNECTING SPEAKERS

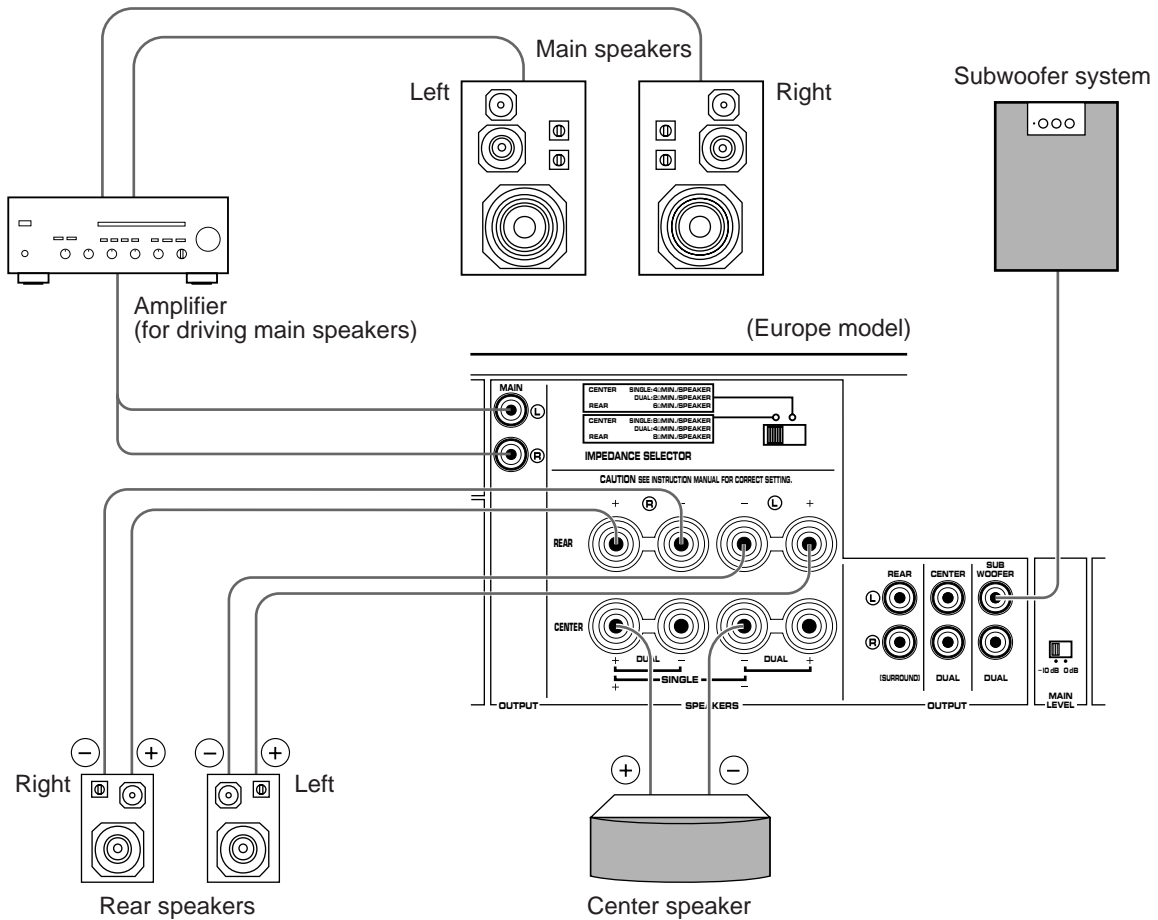

How to Connect to the REAR and CENTER SPEAKERS terminals

Connect the **SPEAKERS** terminals to your speakers with wire of the proper gauge, cut as short as possible. If the connections are faulty, no sound will be heard from the speakers. Make sure that the polarity of the speaker wires is correct, that is the + and – markings are observed. If these wires are reversed, the sound will be unnatural and lack bass.

Caution

Do not let the bare speaker wires touch each other and do not let them touch any metal part of this unit. This could damage this unit and/or speakers.

Note

Use speakers with the specified impedance shown on the rear of this unit.

Red: positive (+)
Black: negative (–)

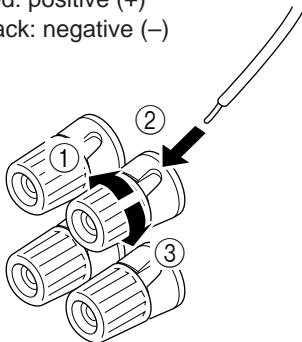

- ① Unscrew the knob.
- ② Insert the bare wire.
[Remove approx. 5mm (1/4") insulation from the speaker wires.]
- ③ Tighten the knob and secure the wire.

<General model only>

Banana Plug connections are also possible. Simply insert the Banana Plug connector into the corresponding terminal.

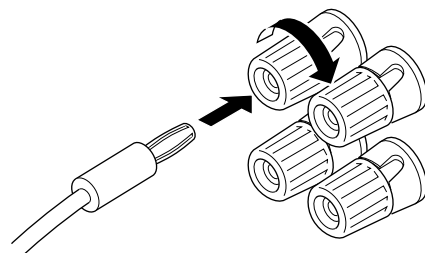

On main speaker connection

This unit is not equipped with amplifiers for driving main speakers, so connect an external amplifier (power amplifier, integrated amplifier, receiver, etc.) for driving main speakers to this unit.

Connect the MAIN OUTPUT terminals of this unit to the MAIN IN (or equivalent) terminals of the external amplifier, and connect the main speakers to the speaker terminals of the external amplifier.

Notes

- If the external amplifier does not have the MAIN IN (or equivalent) terminals, this unit can be connected to the AUX (or TAPE PB) input terminals of the amplifier. If you did so, make sure to select the "AUX" (or "TAPE") input source position and do not change to another input source selection.
- To obtain the best performance of this unit, set the volume control on the external amplifier to about the halfway position between the min. and max.

On center speaker connection

One or two center speakers can be connected to this unit. If you cannot place the center speaker on or under the TV, it is recommended to use two center speakers and place them on both sides of the TV to orient the center sound at the center position. For connecting two center speakers, follow the method shown below.

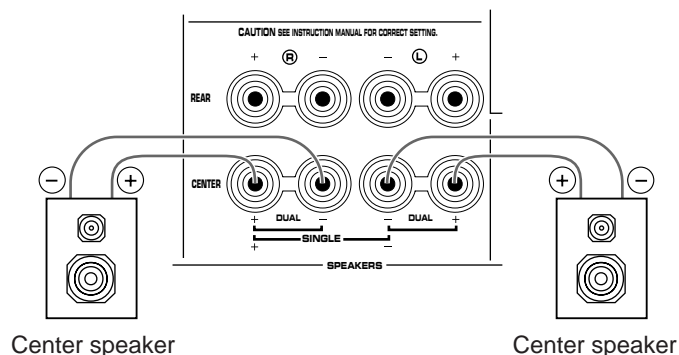

On subwoofer connection

You may wish to add a subwoofer to reinforce the bass frequencies.

If you use one subwoofer, connect either of the SUBWOOFER OUTPUT terminals to the INPUT terminal of the subwoofer amplifier, and connect the speaker terminals of the subwoofer amplifier to the subwoofer.

If you wish to obtain more presence in your listening room, the use of two subwoofers is recommended. To connect two subwoofers to this unit, connect one SUBWOOFER OUTPUT terminal to the INPUT terminal of the amplifier driving a subwoofer, and the other SUBWOOFER OUTPUT terminal to the INPUT terminal of the amplifier driving the other subwoofer, and then connect each subwoofer to the corresponding amplifier.

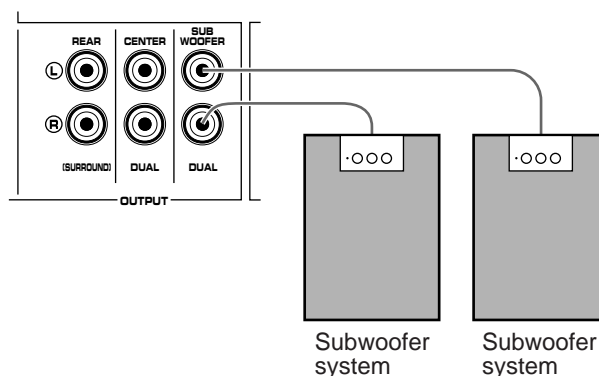

With some subwoofers, including the Yamaha Active Servo Processing Subwoofer System, the amplifier and subwoofer are in the same unit.

2 When connecting with your existing integrated amplifier or receiver which cannot receive signals with the Dolby Digital (AC-3) decoded

(This diagram shows this unit is connected with the Yamaha DSP-A2070 which is equipped with the digital sound field processor, the Dolby Pro Logic Surround Decoder and seven-speaker driving amplifiers.)

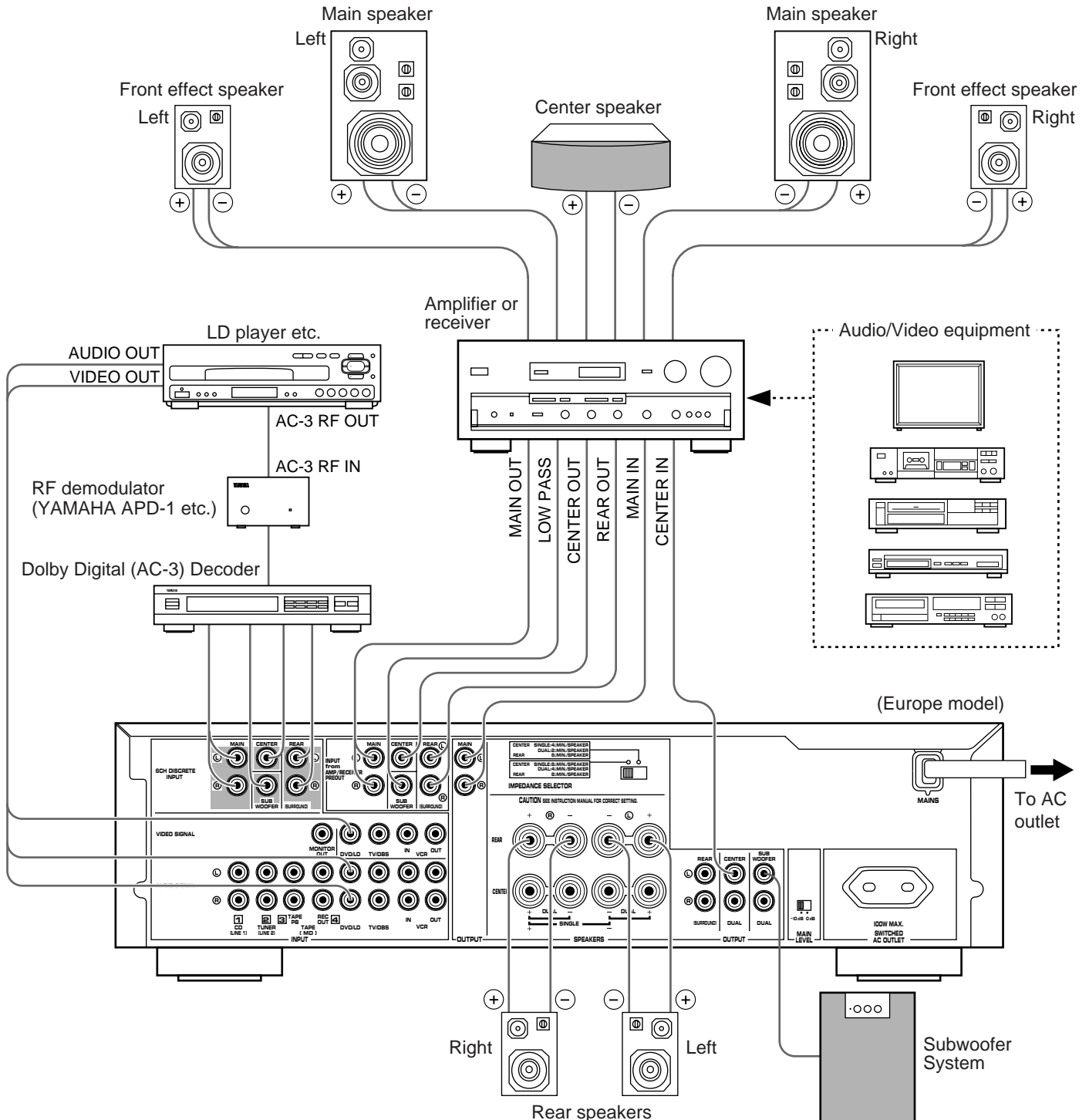

Notes

- For the connections to this unit's 6CH DISCRETE INPUT terminals, refer to page 11.
- For the connections of rear speakers and subwoofer(s) to this unit, refer to page 12 – 13.
- If you select this connecting way, the **PROCESSOR SELECTOR** switch on the front panel must be normally set to the "EXTERNAL" position. When you will play a source on the LD player etc. (connected to this unit) with the Dolby Digital (AC-3) decoded, set the **PROCESSOR SELECTOR** switch to the "INTERNAL" position.

CONTROLS AND THEIR FUNCTIONS

FRONT PANEL

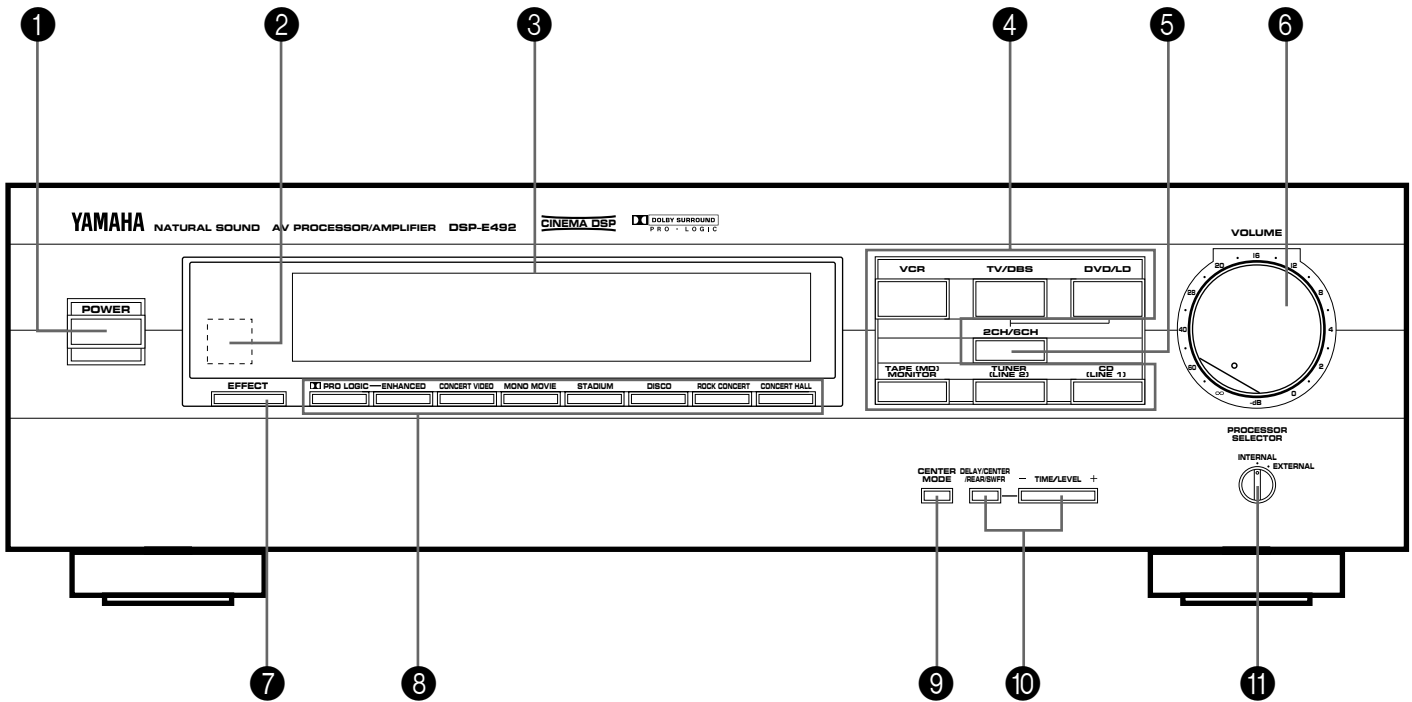

1 POWER switch

Press this switch to switch the power on. Press it again to switch the power off.

2 Remote control sensor

Receives signals from the remote control transmitter.

3 Display panel

Shows various information. (Refer to page 17 for details.)

4 Input selector buttons

Select a program source to listen to or watch. When a button is pressed, the name of selected source appears on the display.

5 2CH/6CH selector button

When the TV/DBS or DVD/LD input source is selected, pressing this button switches the input signals between 2 channel stereo signals and 6 channel discrete signals. When switched to "6CH", signals from the Dolby Digital (AC-3) Decoder etc. connected to the 6CH DISCRETE INPUT terminals of this unit are selected as the input signals.

6 VOLUME control

Used to raise or lower the volume level.

7 EFFECT button

Switches on/off the digital sound field processor (including the Dolby Pro Logic Surround decoder).

8 DSP program selector buttons

Select a DSP program. When a button is pressed, the name of selected program lights up on the display.

9 CENTER MODE button

Selects a center channel output mode (NORMAL, WIDE or PHANTOM). (For details, refer to page 18.)

10 DELAY/CENTER/REAR/SWFR and TIME/LEVEL +/- buttons

Adjust the delay time (DELAY), the center channel output level (CENTER), the rear channel output level (REAR) and the output level to the SUBWOOFER OUTPUT terminal (SWFR). Select the item which you want to adjust by pressing the DELAY/CENTER/REAR/SWFR button and adjust its time or level by pressing the TIME/LEVEL +/- button.

11 PROCESSOR SELECTOR switch

When you play a source on an audio/video unit connected to this unit, set this switch to the "INTERNAL" position. When you listen to sound reproducing signals input to the INPUT (from AMP/RECEIVER PREOUT) terminals on the rear panel from the external amplifier etc., set this switch to the "EXTERNAL" position.

REMOTE CONTROL TRANSMITTER

The remote control transmitter provided with this unit is designed to control all the most commonly used functions of this unit. If the CD player, tuner and tape deck connected to this unit are YAMAHA components designed for remote control compatibility, then this remote control transmitter will also control various functions of each component.

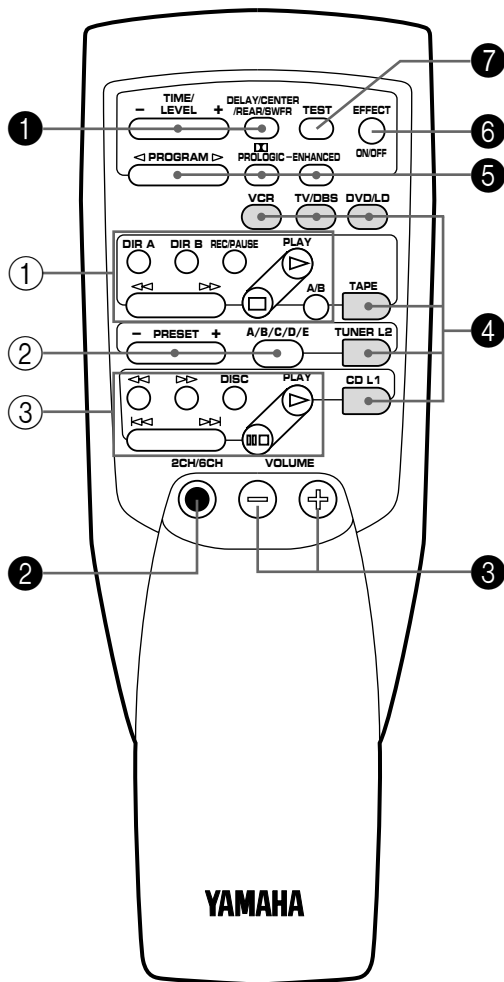

For Control of This Unit

1 DELAY/CENTER/REAR/SWFR and TIME/LEVEL +/- keys

Adjust the delay time (DELAY), the center channel output level (CENTER), the rear channel output level (REAR) and the output level to the SUBWOOFER OUTPUT terminal (SWFR). Select the item which you want to adjust by pressing the **DELAY/CENTER/REAR/SWFR** key and adjust its time or level by pressing the **TIME/LEVEL +/-** key.

2 2CH/6CH selector key

When the **TV/DBS** or **DVD/LD** input source is selected, pressing this key switches the input signals between 2 channel stereo signals and 6 channel discrete signals. When switched to "6CH", signals from the Dolby Digital (AC-3) Decoder etc. connected to the 6CH DISCRETE INPUT terminals of this unit are selected as the input signals.

3 VOLUME +/- keys

Turns the volume level up/down.

4 Input selector keys

Selects input source.

5 Program selector keys

PROGRAM:

When the built-in digital sound field processor (including the Dolby Pro Logic Surround decoder) is on, this key changes the currently selected DSP program whenever the right or left side of this key is pressed.

PROLOGIC:

Directly selects the **PRO LOGIC** program.

ENHANCED:

Directly selects the **PRO LOGIC ENHANCED** program.

6 EFFECT ON/OFF key

Switches on/off the digital sound field processor (including the Dolby Pro Logic Surround decoder).

7 TEST key

Used for speaker balance adjustment. (For details, refer to page 18 – 19.)

For Other Component Control

Identify the remote control transmitter keys with your component's keys. If these keys are identical, their functions will be the same. On each key function, refer to the corresponding instruction on your component's manual.

① Tape deck keys

Controls tape deck.

* **DIR A, B** and **A/B** are applicable only to double cassette tape deck.

* For a single cassette deck with automatic reverse function, pressing **DIR A** will reverse the direction of tape running.

② Tuner keys

Controls tuner.

+: Selects higher preset station number.

-: Selects lower preset station number.

A/B/C/D/E: Selects the group (A – E) of preset station numbers.

③ CD player keys

Controls compact disc player.

* **DISC** is applicable only to compact disc changer.

DISPLAY PANEL

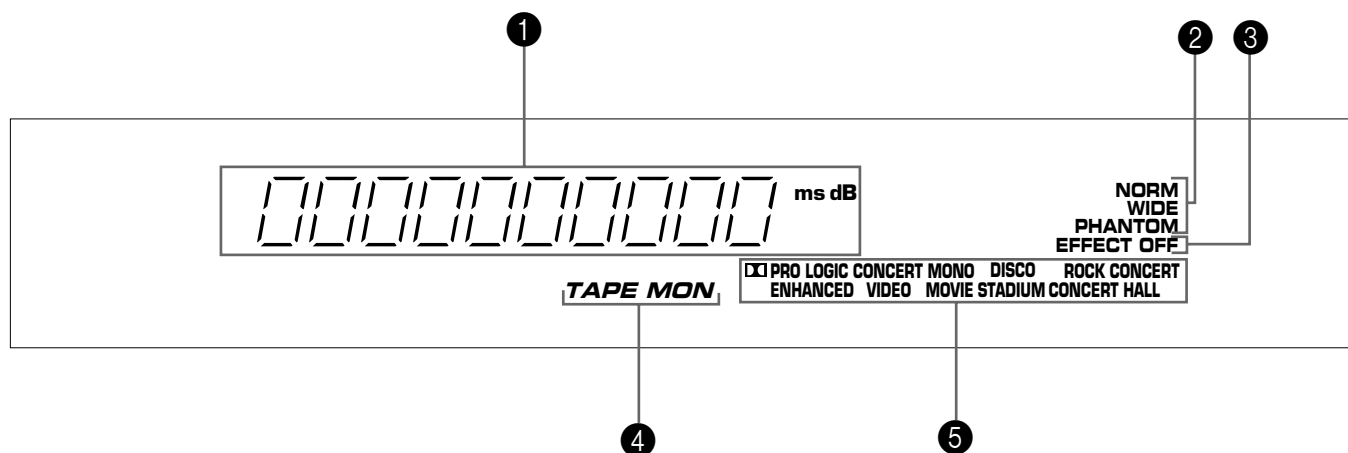

① Multi-information display

Displays various information, for example name of selected DSP program and name of selected input source.

② Center channel mode indicators

The name of a selected center channel mode lights up only when a program which uses the Dolby Pro Logic Surround decoder is selected.

③ EFFECT OFF indicator

Lights up if neither the digital sound field processor nor the Dolby Pro Logic Surround decoder is on. In this state, sound output is 2-channel stereo.

④ TAPe MON indicator

Lights up when the tape deck (or MD recorder etc.) is selected as the input source by pressing the **TAPe (MD) MONITOR** button.

⑤ DSP program indicators

The name of a selected DSP program lights up when the built-in digital sound field processor and/or the Dolby Pro Logic Surround decoder is on.

SPEAKER BALANCE ADJUSTMENT

This procedure lets you adjust the sound output level balance between the main, center, and rear speakers using the built-in test tone generator. When this adjustment is performed, the sound output level heard at the listening position will be the same from each speaker. This is important for the best performance of the digital sound field processor and the Dolby Pro Logic Surround decoder.

The adjustment of each speaker output level should be done at your listening position with the remote control transmitter. Otherwise, the result may not be satisfactory.

Note
If this unit is connected with a Dolby Digital (AC-3) Decoder and/or an amplifier (or receiver) equipped with the Dolby Pro Logic Decoder or the digital sound field processor, also make an output balance adjustment using the test tone on each unit.

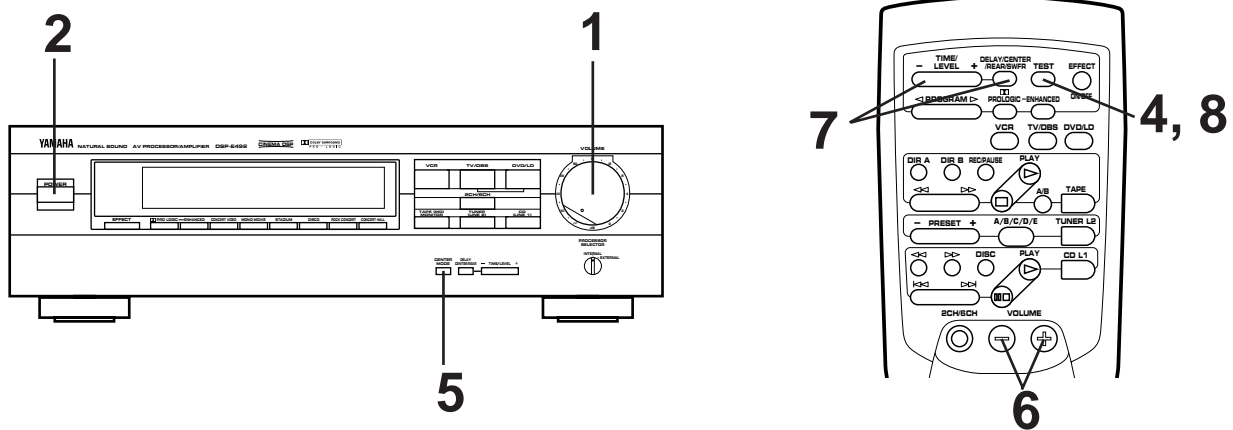

1

Set to the "∞" position.

2 Turn on the power of this unit and the external amplifier etc.

3 Set the balance control, tone controls, etc. on the external amplifier to the "flat" position.

4

TEST LEFT

5 Select the center channel output mode suitable for your speaker configuration.
(Refer to "SPEAKER CONFIGURATION" on page 7.)

```

    graph TD
      CM[CENTER MODE] --> N[NORMAL]
      N --> W[WIDE]
      W --> P[PHANTOM]
    
```

On the feature of each mode, refer to the "Note" shown below.

Note
In step 5, when you select a center channel output mode, note the following.

- For 5-speaker configuration)**
NORMAL: Select this mode when you use a center speaker that is smaller than the main speakers. In this mode, the bass tone will be output from the main speakers.
- WIDE:** Select this mode when you use the center speaker approximately same sized as the main speakers.
- For 4-speaker configuration)**
PHANTOM: Select this mode when you do not use the center speaker. The center sound will be output from the left and right main speakers.

6 Turn up the volume.

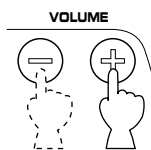

You will hear a test tone (like pink noise) from the left main speaker, then the center speaker, then the right main speaker, and then the rear speakers, for about two seconds each. The display changes as shown below.

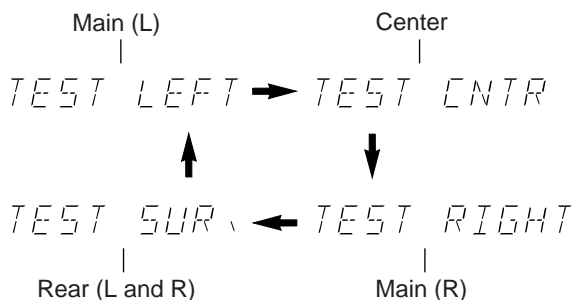

* The test tone from the left rear speaker and the right rear speaker will be heard at the same time.

7 Adjust the sound output levels of the center speaker and the rear speakers so that they become almost as same as that of the main speakers.

a) Press once or more so that "CENTER" or "REAR" appears on the display.

* Select "CENTER" to adjust the output level of the center speaker, and select "REAR" to adjust the output level of the rear speakers.



b) Adjust its level.

* Pressing the + side raises and the - side lowers the level.

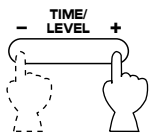

8 Cancel the test tone.

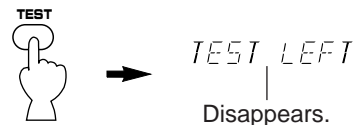

Notes

- Once you have completed these adjustments, you can adjust whole sound level on your audio system by using this unit's **VOLUME** control (or the **VOLUME** keys on the remote control transmitter) only.
- You may also use the volume controls on the external amplifiers etc. to achieve proper balance.
- In step 7, if the center channel mode is in the "PHANTOM" position, the sound output level of the center speaker cannot be adjusted. This is because in this mode, the center sound is automatically output from the left and right main speakers.

<U.K. and Europe models only>

- If there is insufficient sound output from the center and rear speakers, you may decrease the main speaker output level by setting the **MAIN LEVEL** switch on the rear panel to "-10 dB".

BASIC OPERATIONS

TO PLAY A SOURCE

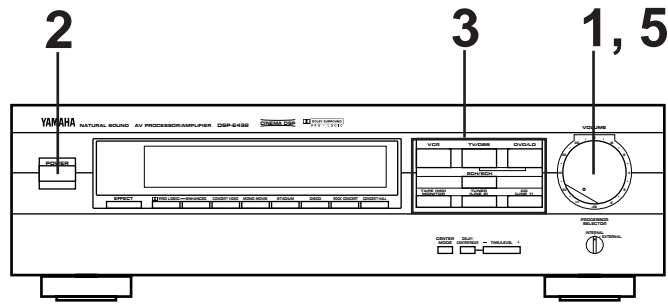

1

Set to the "∞" position.

2 Turn on the power of this unit and other audio/video units to be used.

3 Select the desired input source by using the input selector buttons.
(For video sources, turn the TV/monitor ON.)

* The name of the selected input source will appear on the display

4 Play the source.

5

Adjust to the desired output level.

6 If desired, use the digital sound field processor. (Refer to page 24.)

Note
Confirm that the **PROCESSOR SELECTOR** switch is set to the "INTERNAL" position. If it is set to the "EXTERNAL" position, switch it to the "INTERNAL" position.

Notes on using the input selector buttons

- Note that pressing on each input selector button selects the source which is connected to the corresponding input terminals on the rear panel.
- The selection of **TAPE (MD) MONITOR** cannot be canceled by pressing another input selector button. To cancel it, press **TAPE (MD) MONITOR** again so that "TAPE MON" disappears from the display. When you select a button other than **TAPE (MD) MONITOR**, make sure that "TAPE MON" is not illuminated on the display.
- If you select the input selector button for a video source without canceling the selection of **TAPE (MD) MONITOR**, the playback result will be the video image from the video source and the sound from the audio tape (or MD etc.).
- Once you play a video source, its video image will not be interrupted even if the input selector button for an audio source is selected.

To turn off the power
Press the **POWER** switch again.

To listen to a decoded source using Dolby Digital (AC-3) by reproducing the signals input to the 6CH DISCRETE INPUT terminals of this unit.

In step 3, select **TV/DBS** or **DVD/LD**, and then press the **2CH/6CH** button so that "6ch" appears on the display. Signals from the Dolby Digital (AC-3) Decoder etc. connected to the 6CH DISCRETE INPUT terminals of this unit are selected as the input signals.

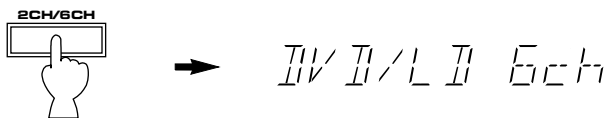

To cancel it, press the **2CH/6CH** button again or select another input source.

Note for reproducing discrete signals with Dolby Digital (AC-3) decoded:

1. Your speaker system must include a center speaker.
2. Your speaker system must include a subwoofer.
 - * Connect a subwoofer which has a built-in amplifier to one of the SUBWOOFER OUTPUT terminals of this unit. (One more subwoofer system can be connected to the other SUBWOOFER OUTPUT terminal.)
 - * You can do without using a subwoofer. If you do so, you should make a setting for distributing signals at the LFE channel to the right and left MAIN output terminals on the Dolby Digital (AC-3) Decoder. For details, refer to the owner's manual for the Dolby Digital (AC-3) Decoder.

Notes

- When you switch to the "6CH" mode, the built-in Digital Sound Field processor will not work and adjustment of delay time cannot be made.
- Switching this unit to the "6CH" mode will input no signal to this unit if there is no connection to the 6CH DISCRETE INPUT terminals of this unit.

To listen to sound by reproducing signals input to the INPUT (from AMP/RECEIVER PREOUT) terminals on the rear panel from the external amplifier etc.

1. Adjust the volume to minimum on the external amplifier.
2. Turn on the power of the audio/video units (including this unit) to be used.
3. Set the **PROCESSOR SELECTOR** switch on the front panel of this unit to the "EXTERNAL" position.

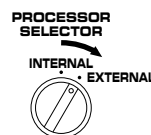

4. Play the source.
5. Increase the volume to a desired listening level gradually on the external amplifier etc.
6. If desired, adjust the balance, tone, etc. on the external amplifier etc.

Note

When you will not use signals input to the INPUT (from AMP/RECEIVER PREOUT) terminals on the rear panel, make sure to set the **PROCESSOR SELECTOR** switch to the "INTERNAL" position.

TO RECORD A SOURCE TO TAPE (OR MD)

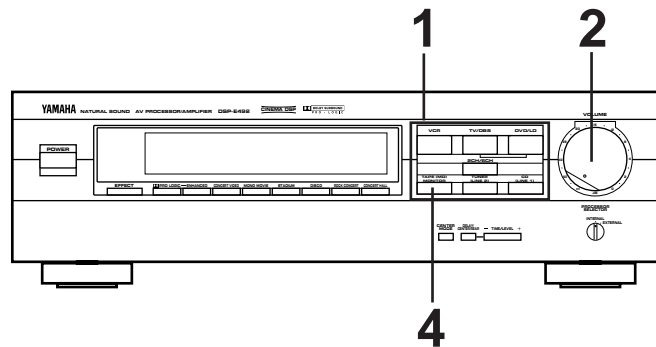

- 1** Select the source to be recorded.

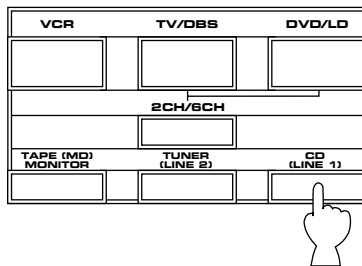

- 2** Play the source and then turn the **VOLUME** control up to confirm the input source.

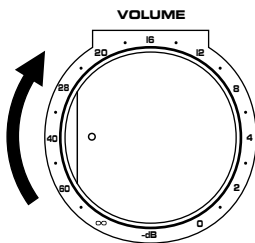

- 3** Begin recording on the tape deck (or MD recorder etc.) or VCR connected to this unit.

- 4** If the tape deck (or MD recorder etc.) is used for recording, you can monitor the sounds being recorded by pressing **TAPE (MD) MONITOR** so that "TAPE MON" lights up on the display.

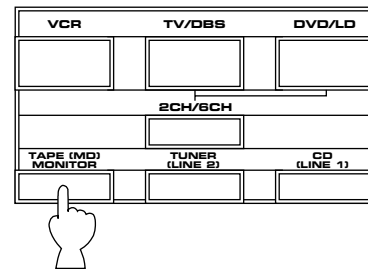

Notes

- In step 1, do not make an input source selection so that "6ch" appears on the display. Signals input to this unit's 6CH DISCRETE INPUT terminals cannot be recorded by a tape deck, MD recorder or VCR.
- The settings of DSP and the **VOLUME** control have no effect on the material being recorded.

USING DIGITAL SOUND FIELD PROCESSOR (DSP)

This unit incorporates a sophisticated, multi-program digital sound field processor. The processor allows you to electronically expand and change the shape of the audio sound field from both audio and video sources, creating a theater-like experience in your listening room. You can create an excellent audio sound field by selecting a suitable sound field program (this will, of course, depend on what you will be listening to), and adding desired adjustments.

In addition, this unit incorporates a Dolby Pro Logic Surround decoder for multi-channel sound reproduction of sources encoded with Dolby Surround. The operation of the Dolby Pro Logic Surround decoder can be controlled by selecting a corresponding DSP program including a combined operation of the Yamaha DSP and the Dolby Pro Logic Surround.

Brief Overview of Digital Sound Field Programs

The following list gives you a brief description of the sound fields produced by each of the DSP programs. Keep in mind that most of these are precise digital recreations of actual acoustic environments. The data for these sound fields was recorded at actual locations using sophisticated sound field measurement equipment.

Note
The channel level balance between the left and right rear effect speakers may vary depending on the sound field you are listening to. This is due to the fact that most of these sound field recreations are actual acoustic environments.

PROGRAM	FEATURE
<input checked="" type="checkbox"/> PRO LOGIC	This program is used for playback of sources encoded with Dolby Surround. The application of a sophisticated digital signal processing system reduces crosstalk and directs or steers the sound source more smoothly and precisely, as compared to conventional types.
<input checked="" type="checkbox"/> PRO LOGIC ENHANCED	This program is also used for playback of sources encoded with Dolby Surround. Enhancing the "Normal" Dolby Pro Logic, the DSP technology simulates the multi-surround speaker systems of a 35 mm movie theater. This effect creates a wide surround sound field, and expands the sound stage with an improved presence image. This program is used for musical based movies, as well as drama and comedy based movies.
CONCERT VIDEO	This program is effective for music videos and gives excellent depth and clarity for vocals. For opera, the orchestra and stage are ideally recreated, letting you feel as if you were in an actual concert hall.
MONO MOVIE	This program is designed specifically to enhance mono source programs. Compared to a strictly mono setting, the sound image created in this mode is wider and slightly forward of the speaker pair, lending an immediacy to the overall sound. It is particularly effective when used with old mono movies, news broadcasts and dialog.
STADIUM	This program gives you long delays between direct sounds and effect sounds, and extraordinarily spacious feel of a large stadium.
DISCO	This program recreates the acoustic environment of a lively disco in the heart of a very lively city. The sound is dense and highly concentrated. It is also characterized by a high-energy, "immediate" sound.
ROCK CONCERT	This program is ideally suited for rock music. You will experience a very dynamic or lively sound field.
CONCERT HALL	In this program, the center will appear to be deep behind the main speakers, creating an expansive large hall ambience. Orchestra and opera music are suited for this sound field.

To play a source with the digital sound field processor

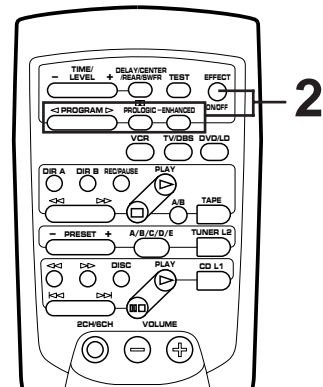
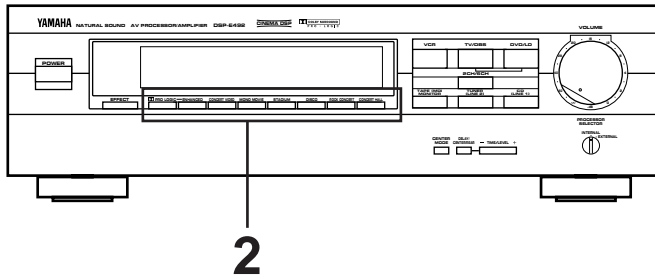

1 Follow steps 1 – 5 shown in “**BASIC OPERATIONS**” on page 20.

2 Select the desired program that is suitable for the source.

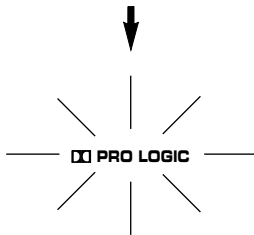
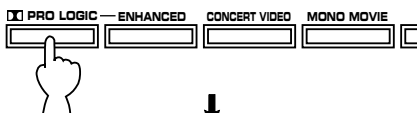

The selected program name is shown on the display.

3 If desired, adjust the delay time and the output level of each speaker. (For details, refer to the corresponding descriptions on page 25 and 26.)

Notes

- Program selection can be made to individual input sources. Once you select a program, it is linked with the input source selected at that time. So, when you select the input source next time, the same program is automatically called.
- If you prefer to cancel the DSP, press the **EFFECT** button. The sound will be the normal 2-channel stereo without surround sound effect.
- When **CONCERT VIDEO**, **MONO MOVIE**, **STADIUM**, **DISCO**, **ROCK CONCERT** or **CONCERT HALL** is selected, no sound is heard from the center speaker.

- When a monaural sound source is played with **DOLBY PRO LOGIC** or **DOLBY PRO LOGIC ENHANCED**, no sound is heard from the main speakers and the rear speakers. Sound is heard only from the center speaker. However, if the center channel mode is in **PHANTOM**, the main speakers output the sound of the center channel.
- To select a DSP program on the remote control transmitter, first turn the DSP on so that a program name lights up on the display by pressing the **EFFECT** key. Next, select a desired DSP program by pressing the **<** or **>** side of **PROGRAM** key.

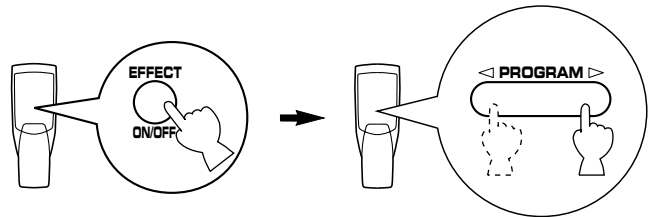

* Pressing the **PROLOGIC** or **ENHANCED** key turns the DSP on and selects the corresponding program directly.

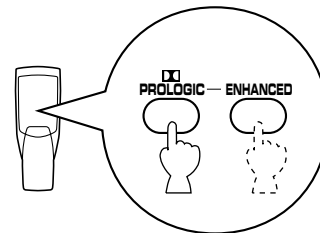

Adjustment of the CENTER LEVEL

If desired, you can adjust the sound output level of the center speaker even if the output level is already set in “**SPEAKER BALANCE ADJUSTMENT**” on page 19.

- 1 Press once or more so that “CENTER” appears on the display.

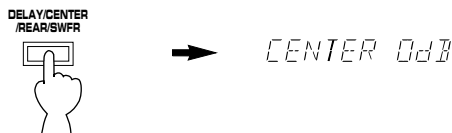

- 2 By continuously pressing the “+” or “-” side of the **TIME/LEVEL** button, the level value changes continuously. The value stops changing momentarily at the preset point (0 dB).

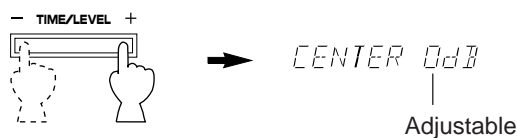

Control range: MIN, -20 to +10 dB

Notes

- This adjustment can be made only when the digital sound field program **DOLBY PRO LOGIC** or **DOLBY PRO LOGIC ENHANCED** is selected, or the “6CH” input source mode is selected.
- Once the output level is adjusted, the level value will be the same in all the digital sound field programs mentioned above.

Adjustment of the REAR LEVEL

If desired, you can adjust the sound output level of the rear speakers even if the output level is already set in “**SPEAKER BALANCE ADJUSTMENT**” on page 19.

- 1 Press once or more so that “REAR” appears on the display.



- 2 By continuously pressing the “+” or “-” side of the **TIME/LEVEL** button, the level value changes continuously. The value stops changing momentarily at the preset point (0 dB).

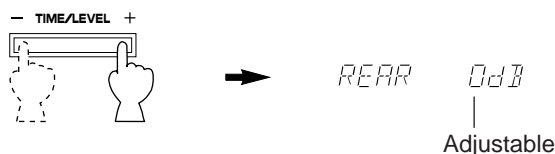

Control range: MIN, -20 to +10 dB

Notes

- This adjustment can be made only when the built-in digital sound field processor is on, or the “6CH” input source mode is selected.
- Once the output level is adjusted, the level value will be the same in all the digital sound field programs.

Adjustment of DELAY TIME

You can adjust the time difference between the beginning of the sound from the main speakers and the beginning of the effect sound from the rear speakers.

The larger the value, the later the effect sound is generated. This adjustment can be made to all programs individually.

PRO LOGIC	: from 15 to 30 milliseconds (Preset value: 20 milliseconds)
PRO LOGIC ENHANCED	: from 15 to 30 milliseconds (Preset value: 20 milliseconds)
CONCERT VIDEO	: from 1 to 100 milliseconds (Preset value: 28 milliseconds)
MONO MOVIE	: from 1 to 100 milliseconds (Preset value: 20 milliseconds)
STADIUM	: from 1 to 50 milliseconds (Preset value: 45 milliseconds)
DISCO	: from 1 to 100 milliseconds (Preset value: 14 milliseconds)
ROCK CONCERT	: from 1 to 100 milliseconds (Preset value: 17 milliseconds)
CONCERT HALL	: from 1 to 100 milliseconds (Preset value: 30 milliseconds)

- 1 Press once or more so that "DELAY" appears on the display.

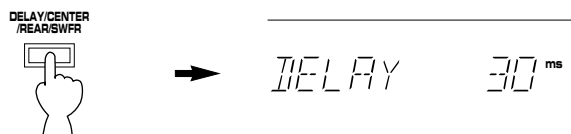

- 2 By continuously pressing the "+" or "-" side of the **TIME/LEVEL** button, the value changes continuously. The value stops changing momentarily at the preset point.



Notes

- Adding too much delay will cause an unnatural effect with some sources.
- When the **TIME/LEVEL** button is pressed, sound is momentarily interrupted.

Note

The values of the delay time, center level and rear level you set the last time will remain memorized even when the power of this unit is off.

However, if the power cord is kept disconnected for more than one week, these values will be automatically changed back to the original factory settings.

TROUBLESHOOTING

If the unit fails to operate normally, check the following points to determine whether the fault can be corrected by the simple measures suggested. If it cannot be corrected, or if the fault is not listed in the SYMPTOM column, disconnect the power cord and contact your authorized YAMAHA dealer or service center for help.

	SYMPTOM	CAUSE	REMEDY
Amplifier	The unit fails to turn on when the POWER switch is pressed, or turns off suddenly soon after the power is turned on.	Power cord is not plugged in or is not completely inserted.	Firmly plug in the power cord.
		The IMPEDANCE SELECTOR switch on the rear panel is not set to the left or right end exactly.	Set the switch to the left or right end exactly.
	No sound or no picture.	Incorrect output cord connections.	Connect the cords properly. If the problem persists, the cords may be defective.
		Appropriate input source is not selected.	Select an appropriate input source with the input selector buttons.
		The PROCESSOR SELECTOR switch on the front panel is set to the "EXTERNAL" position.	When you will not use signals input to the INPUT (from AMP/RECEIVER PREOUT) terminals on the rear panel, make sure to set the PROCESSOR SELECTOR switch to the "INTERNAL" position.
		Speaker connections are not secure.	Secure the connections.
	The sound suddenly goes off.	The protection circuit has been activated because of short circuit etc.	Turning the unit off and then on will reset the protection circuit.
	Only one side speaker outputs the sound.	Incorrect cord connections.	Connect the cords properly. If the problem persists, the cords may be defective.
	Sound "hums".	Incorrect cord connections.	Firmly connect the audio plugs. If the problem persists, the cords may be defective.
	The volume level cannot be increased, or sound is distorted.	The power to the component connected to the REC OUT terminals of this unit is off.	Turn the power to the component on.
	No sound from the main speakers.	The volume is adjusted to minimum on the external amplifier driving the main speakers.	Increase the volume on the external amplifier.
		Incorrect cord connections.	Connect the cords properly. If the problem persists, the cords may be defective.
	No sound from the rear speakers.	The sound output level to the rear speakers is set to 0.	Raise the sound output level to the rear speakers.
		The monaural sound source is played in DOLBY PRO LOGIC or DOLBY PRO LOGIC ENHANCED mode.	Select another program suitable for the monaural sound source.
No sound from the center speaker.	The sound output level to the center speaker is set to 0.	Raise the sound output level to the center speaker.	
	The center channel mode is in PHANTOM mode.	Select NORMAL or WIDE.	
	Incorrect sound field program selection.	Select the appropriate program.	
The remote control transmitter does not work.	Direct sunlight or lighting (of an inverter type of fluorescent lamp etc.) is striking the remote control sensor of the main unit.	Change the position of the main unit.	
	The batteries of this remote control transmitter are too weak.	Replace the batteries with new ones.	
Others	The sound is degraded when listening with the headphones connected to the compact disc player or cassette deck that are connected with this unit.	The power to this unit is off.	Turn the power to this unit on.
	Noise from nearby TV or tuner.	This unit is too close to the affected equipment.	Move the unit further away from the affected equipment.

SPECIFICATIONS

AUDIO SECTION

Minimum RMS Output Power per Channel

8 ohms, 20 Hz to 20 kHz, 0.04% THD (When 3 channels are driven:)

6CH DISCRETE INPUT to CENTER	60W
6CH DISCRETE INPUT to REAR.....	60W+60W

Dynamic Power per Channel

(by IHF Dynamic Headroom measuring method)

[U.S.A. and Canada models]	
8/6/4/2 ohms.....	110/130/150/165W
[Europe, U.K., Australia and General models]	
8/6/4/2 ohms.....	115/140/160/175W

DIN Standard Output Power per Channel [Europe model only]

4 ohms, 1 kHz, 0.7% THD

CENTER, REAR.....	70W
-------------------	-----

IEC Power [Europe model only]

8 ohms, 1 kHz, 0.1% THD (When 3 channels are driven:)

CENTER, REAR.....	75W
-------------------	-----

Power Band Width

8 ohms, 30W, 0.1% THD

CENTER, REAR	10 Hz to 60 kHz
--------------------	-----------------

Damping Factor

8 ohms, 1 kHz

CENTER, REAR.....	200 or more
-------------------	-------------

Input Sensitivity/Input Impedance

6CH DISCRETE INPUT

to MAIN PRE OUT (1V).....	150 mV/47 k-ohms
to CENTER SP OUT (60W).....	150 mV/47 k-ohms
to REAR SP OUT (60W)	150 mV/47 k-ohms
to SUBWOOFER PREOUT (3.5V)	100 mV/30 k-ohms

Output Level/Output Impedance

REC OUT.....	150 mV/2.7 k-ohms
MAIN PRE OUT	1V/2.7 k-ohms
CENTER PRE OUT	2V/1.2 k-ohms
REAR PRE OUT	2V/1.2 k-ohms
SUBWOOFER	4V/1.2 k-ohms

Maximum Voltage Output

20 Hz to 20 kHz, 0.01% THD

MAIN PRE OUT	1.6V
--------------------	------

Frequency Response

CENTER, REAR (20 Hz to 20 kHz)	0±0.5 dB
MAIN PRE OUT (20 Hz to 20 kHz)	0±0.5 dB
SUBWOOFER PRE OUT (150 Hz)	-3 dB

Total Harmonic Distortion

6CH DISCRETE INPUT

to MAIN PRE OUT (20 Hz to 20 kHz, 1V).....	0.006% or less
to CENTER SP OUT (20 Hz to 20 kHz, 50W/8 ohms)	0.015% or less
to REAR SP OUT (1 kHz, 50W/8 ohms).....	0.015% or less
to SUBWOOFER PRE OUT (50 Hz, 3.5V)	0.015% or less

Signal-to-Noise Ratio (IHF-A Network) (Shorted)

6CH DISCRETE INPUT

to MAIN PRE OUT	95 dB or more
to CENTER SP OUT.....	90 dB or more
to REAR SP OUT.....	90 dB or more

Residual Noise (IHF-A Network)

6CH DISCRETE INPUT

to MAIN PRE OUT	5.0 µV or less
to CENTER SP OUT.....	270 µV or less
to REAR SP OUT	270 µV or less

Channel Separation (Vol. -30 dB)

6CH DISCRETE INPUT to MAIN PRE OUT
(Input 5.1 k-ohms Shorted)

1 kHz.....	70 dB or more
10 kHz.....	50 dB or more

GENERAL

Power Supply

[U.S.A. and Canada models].....	AC 120V, 60 Hz
[Europe and U.K. models]	AC 230V, 50 Hz
[Australia model]	AC 240V, 50 Hz
[General model].....	AC 110/120/220/240V, 50/60 Hz

Power Consumption

[U.S.A. model]	160W
[Canada model]	160W/220 VA
[Europe, U.K., Australia and General models].....	200W

Maximum Power Consumption

[General model only]	600W
----------------------------	------

AC Outlet

SWITCHED.....	100W max.
---------------	-----------

Dimensions (W x H x D)435 x 126 x 389.5 mm
(17-1/8" x 4-15/16" x 15-5/16")

Weight8.5 kg (18 lbs. 11 oz.)

AccessoriesRemote control transmitter
Batteries

Specifications are subject to change without notice.

YAMAHA

YAMAHA ELECTRONICS CORPORATION, USA 6660 ORANGETHORPE AVE., BUENA PARK, CALIF. 90620, U.S.A.
YAMAHA CANADA MUSIC LTD. 135 MILNER AVE., SCARBOROUGH, ONTARIO M1S 3R1, CANADA
YAMAHA ELECTRONIK EUROPA G.m.b.H. SIEMENSSTR. 22-34, 25462 RELLINGEN BEI HAMBURG, F.R. OF GERMANY
YAMAHA ELECTRONIQUE FRANCE S.A. RUE AMBROISE CROIZAT BP70 CROISSY-BEAUBOURG 77312 MARNE-LA-VALLEE CEDEX02, FRANCE
YAMAHA ELECTRONICS (UK) LTD. YAMAHA HOUSE, 200 RICKMANSWORTH ROAD WATFORD, HERTS WD1 7JS, ENGLAND
YAMAHA SCANDINAVIA A.B. J A WETTERGRENS GATA 1, BOX 30053, 400 43 VÄSTRA FRÖLUNDA, SWEDEN
YAMAHA MUSIC AUSTRALIA PTY, LTD. 17-33 MARKET ST., SOUTH MELBOURNE, 3205 VIC., AUSTRALIA

YAMAHA CORPORATION

Printed in Malaysia VY82150