



GB

# ***RX-V596RDS***

---

*Natural Sound AV Receiver*  
*Ampli-tuner audio-vidéo*

OWNER'S MANUAL  
MODE D'EMPLOI  
BEDIENUNGSANLEITUNG  
BRUKSANVISNING  
MANUALE DI ISTRUZIONI  
MANUAL DE INSTRUCCIONES  
GEBRUIKSAANWIJZING

## CAUTION: READ THIS BEFORE OPERATING YOUR UNIT.

1. To assure the finest performance, please read this manual carefully. Keep it in a safe place for future reference.
2. Install this unit in a cool, dry, clean place — away from windows, heat sources, sources of excessive vibration, dust, moisture and cold. Avoid sources of humming (transformers, motors). To prevent fire or electrical shock, do not expose the unit to rain or water.
3. Never open the cabinet. If something drops into the unit, contact your dealer.
4. Do not use force on switches, controls or connection cables. When moving the unit, first disconnect the power cord and then the cables connected to other component. Never pull the cables themselves.
5. The openings on the cover assure proper ventilation of the unit. If these openings are obstructed, the temperature inside the unit will rise rapidly. Therefore, avoid placing objects against these openings, and install the unit in a well-ventilated area to prevent fire and damage.  
Be sure to allow a space of at least 20 cm behind, 20 cm on both sides and 30 cm above the top panel of the unit to prevent fire and damage.
6. The voltage used must be the same as that specified on this unit. Using this unit with a higher voltage than specified is dangerous and may result in fire or other accidents. YAMAHA will not be held responsible for any damage resulting from the use of this unit with a voltage other than that specified.
7. Digital signals generated by this unit may interfere with other component such as tuners, receivers and TVs. Move this unit farther away from such component if interference is observed.
8. Always set VOLUME to the “∞” position before starting the audio source play. Increase the volume gradually to an appropriate level after playback has been started.
9. Do not attempt to clean the unit with chemical solvents; this might damage the finish. Use a clean, dry cloth.
10. Be sure to read the “TROUBLESHOOTING” section regarding common operating errors before concluding that the unit is faulty.
11. When not planning to use this unit for a long period of time (e.g., a vacation), disconnect the AC power cord from the wall outlet.
12. To prevent lightning damage, disconnect the AC power cord and disconnect the antenna cable when there is an electrical storm.
13. Grounding or polarization — Precautions should be taken so that the grounding or polarization of the unit is not defeated.
14. AC outlet — Do not connect audio component to the AC outlet on the rear panel if that component requires more power than the outlet is rated to provide.

This unit is not disconnected from the AC power source as long as it is connected to the wall outlet, even if this unit itself is turned off. This state is called the standby mode. In this state, this unit is designed to consume a very small quantity of power.

### ■ For U.K. customers

If the socket outlets in the home are not suitable for the plug supplied with this appliance, it should be cut off and an appropriate 3 pin plug fitted. For details, refer to the instructions described below.

#### Note

- The plug severed from the mains lead must be destroyed, as a plug with bared flexible cord is hazardous if engaged in a live socket outlet.

### ■ Special Instructions for U.K. Model

#### IMPORTANT

THE WIRES IN MAINS LEAD ARE COLOURED IN ACCORDANCE WITH THE FOLLOWING CODE:

Blue: NEUTRAL

Brown: LIVE

As the colours of the wires in the mains lead of this apparatus may not correspond with the coloured markings identifying the terminals in your plug, proceed as follows:

The wire which is coloured BLUE must be connected to the terminal which is marked with the letter N or coloured BLACK. The wire which is coloured BROWN must be connected to the terminal which is marked with the letter L or coloured RED.

Making sure that neither core is connected to the earth terminal of the three pin plug.



# FEATURES

## 5-Channel Power Amplification

- ◆ Minimum RMS Output (0.06% THD, 20 Hz – 20 kHz)
  - Main: 70 W +70 W (8 Ω)
  - Center: 70 W (8 Ω)
  - Rear: 70 W + 70 W (8 Ω)

## Multi-Mode Digital Sound Field Processing

- ◆ Digital Sound Field Processor (DSP)
- ◆ Dolby Pro Logic Decoder
- ◆ Dolby Digital Decoder
- ◆ DTS Decoder
- ◆ CINEMA DSP: Combination of YAMAHA DSP Technology and Dolby Pro Logic, Dolby Digital or DTS

## Sophisticated FM/AM Tuner

- ◆ 40-Station Random Access Preset Tuning
- ◆ Automatic Preset Tuning
- ◆ Preset Station Shifting Capability (Preset Editing)
- ◆ Multi-Functions for RDS Broadcast Reception

## Other Features

- ◆ 96-kHz/24-bit D/A Converter
- ◆ “SET MENU” which Provides You with 12 Items for Optimizing This Unit for Your Audio/Video System
- ◆ Test Tone Generator for Easier Speaker Balance Adjustment
- ◆ 6-Channel External Decoder Input for Other Future Formats
- ◆ S Video Signal Input/Output Capability
- ◆ 3 Optical/2 Coaxial Digital Signal Input Terminals
- ◆ SLEEP Timer
- ◆ Remote Control with Preset Manufacturer Codes



Manufactured under license from Dolby Laboratories. “Dolby”, “Pro Logic” and the double-D symbol are trademarks of Dolby Laboratories. Confidential Unpublished Works. ©1992 – 1997 Dolby Laboratories, Inc. All rights reserved.



Manufactured under license from Digital Theater Systems, Inc. US Pat. No. 5,451,942 and other world-wide patents issued and pending. “DTS”, “DTS Digital Surround”, are trademarks of Digital Theater Systems, Inc. Copyright 1996 Digital Theater Systems, Inc. All Rights Reserved.

# CONTENTS

<b>INTRODUCTION</b>	<b>INTRODUCTION</b>
FEATURES .....	1
CONTENTS .....	1
GETTING STARTED .....	2
CONTROLS AND FUNCTIONS .....	4

<b>PREPARATION</b>	<b>PREPARATION</b>
SPEAKER SETUP .....	9
CONNECTIONS .....	10
ADJUSTING THE SPEAKER BALANCE .....	19

<b>BASIC OPERATION</b>	<b>BASIC OPERATION</b>
PLAYING A SOURCE .....	21
DIGITAL SOUND FIELD PROCESSOR (DSP)	
EFFECT .....	25
TUNING .....	27
RECEIVING RDS STATIONS .....	31
RECORDING A SOURCE ON TAPE, MD OR VIDEO CASSETTE .....	34

<b>ADVANCED OPERATION</b>	<b>ADVANCED OPERATION</b>
SOUND FIELD PROGRAM .....	35
SET MENU .....	38
DELAY TIME AND SPEAKER OUTPUT LEVELS .....	42
SLEEP TIMER .....	44
PRESET REMOTE CONTROL .....	45

<b>APPENDIX</b>	<b>APPENDIX</b>
TROUBLESHOOTING .....	53
SPECIFICATIONS .....	57
GLOSSARY .....	58
INDEX .....	59

indicates a tip for your operation.

- When buttons on this unit and the remote control are noted together in this Owner’s Manual, these button names are in principle noted in the order of “button name (remote control button name)”.

INTRODUCTION

PREPARATION

BASIC OPERATION

ADVANCED OPERATION

APPENDIX

English



# GETTING STARTED

## Checking the Package Contents

Check that the following items are included in your package.

### Remote control

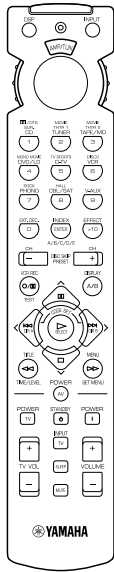

### Batteries (AAA, R03, UM-4 type)

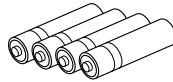

### Indoor FM antenna

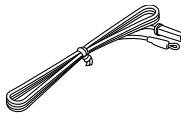

### AM loop antenna



### 75-ohm/300-ohm antenna adapter (U.K. model only)

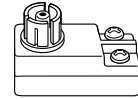

### Quick reference card

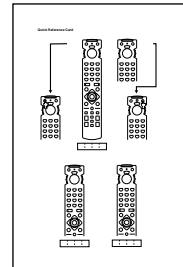

### Connection guide

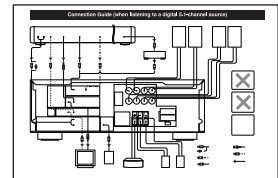

## Battery Installation in the Remote Control

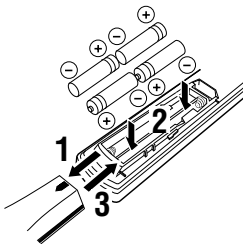

- 1** Turn the remote control over and slide the battery compartment cover in the direction of the arrow.
- 2** Insert the batteries (AAA, R03 or UM-4 type) according the polarity markings on the inside of the battery compartment.
- 3** Close the battery compartment cover.

## Battery Replacement

If the remote control operates only when it is close to the unit, the batteries are weak. Replace all the batteries with new ones.

Be sure to replace the batteries within about two minutes. If it takes longer than two minutes, the codes set for the remote control will return to the factory settings. (Refer to pages 45 to 52 about the remote control.)

### Notes

- Use only AAA, R03 or UM-4 batteries for replacement.
- Be sure the battery polarity is correct. (See the illustration inside the battery compartment.)
- Remove the batteries if the remote control will not be used for an extended period of time.
- If the batteries have leaked, dispose of them immediately. Avoid touching the leaked material or letting it come into contact with clothing, etc. Clean the battery compartment thoroughly before installing new batteries.

## Using the Remote Control

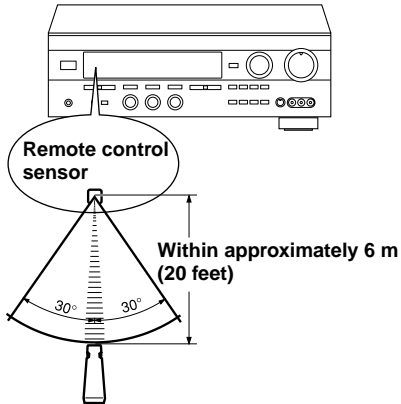

The remote control transmits a directional infrared beam. Be sure to aim the remote control directly at the infrared sensor during operation. When the sensor is covered or there is a large object between the remote control and the sensor, the sensor cannot receive signals. The sensor may not be able to receive signals properly when it is exposed to direct sunlight or a strong artificial light (such as a fluorescent or strobe light). In this case, change the direction of the light or reposition the unit to avoid direct lighting.

### Notes

- Handle the remote control with care.
- Do not spill water, tea or other liquids on the remote control.
- Do not drop the remote control.
- Do not leave or store the remote control in the following conditions:
  - high humidity or temperature such as near a heater, stove or bath;
  - dusty places; or
  - extremely low temperature.



# CONTROLS AND FUNCTIONS

## Front Panel

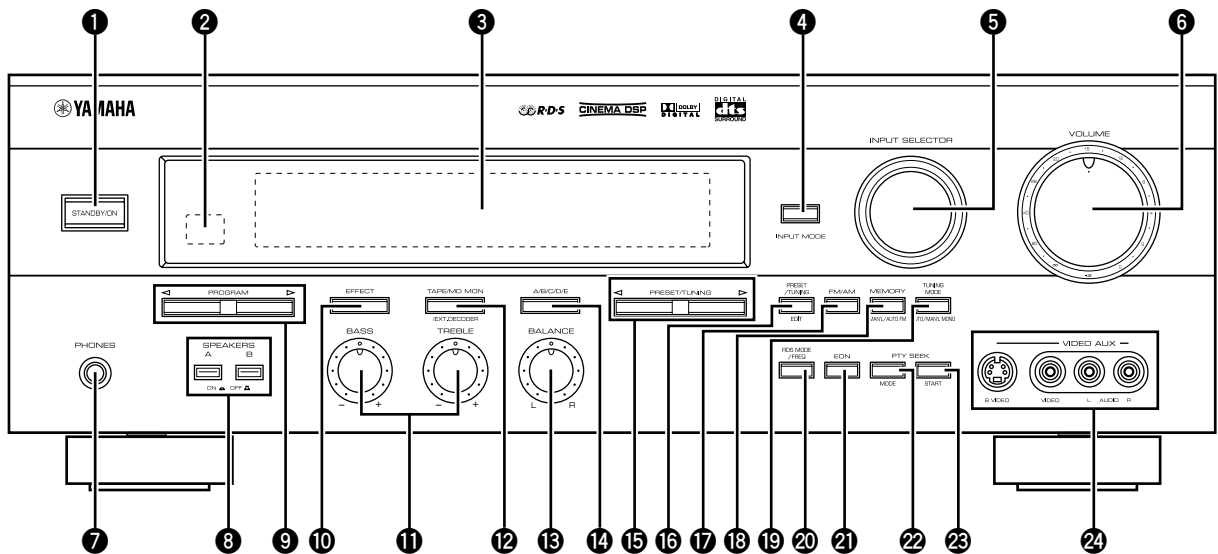

### 1 STANDBY/ON

Press this switch to turn on the power of this unit or to set this unit in the standby mode. Before turning the power on, set VOLUME to the “∞” position.

#### Standby mode

In this mode, this unit consumes a very small quantity of power to receive infrared-signals from the remote control.

### 2 Remote control sensor

This receives signals from the remote control.

### 3 Display

This shows various information. (Refer to page 6 for details.)

### 4 INPUT MODE

Press this button to select the input mode among AUTO, DTS and ANALOG for the DVD/LD, TV/digital TV and cable TV/satellite tuner sources.

### 5 INPUT SELECTOR

Turn this selector to select the input source (TUNER, CD, PHONO, CBL/SAT, V-AUX, VCR, D-TV, DVD/LD) that you want to listen to or watch. The arrow for the selected input source indicator lights up on the display.

### 6 VOLUME

Turn this control to turn up or down the volume.

### 7 PHONES jack

Connect the headphones to the PHONES jack. You can listen to the sound to be output from the main speakers through the headphones.

When listening with headphones privately, set both SPEAKERS A and B to the OFF position, press EFFECT to turn off the effect speakers (center and rear) and set “BASS OUT” on the SET MENU to the MAIN position (so that no DSP program name appears on the display).

### 8 SPEAKERS

Set A or B (or both A and B) to the ON position for the main speaker system (connected to this unit) that you want to use. Set the button(s) to the OFF position for the main speaker system that you don’t want to use.

### 9 PROGRAM selector

Press < or > to select a DSP program when the effect speakers (center and rear) are turned on. The name of the selected program appears on the display.

### 10 EFFECT

Press this button to turn on or off the effect speakers (center and rear). If you turn them off, the signals of the center and rear channels are directed to the right and left main speakers when playing a source encoded with Dolby Digital and DTS. In this case, the output levels of the right and left speakers may not match.

**11 Tone controls**

These controls are only effective for the sound from the main speakers.

**a) BASS**

Turn this control clockwise to increase or counterclockwise to decrease the low-frequency response. The “0” position produces a flat response.

**b) TREBLE**

Turn this control clockwise to increase or counterclockwise to decrease the high-frequency response. The “0” position produces a flat response.

**12 TAPE/MD MON / EXT. DECODER**

Press this button to select a tape or an MD source. The “TAPE/MD MONITOR” indicator lights up on the display. When you press the button again, the “TAPE/MD MONITOR” indicator goes off, “EXT. DECODER” appears on the display and you can listen to a source connected to the EXTERNAL DECODER INPUT terminals.

**13 BALANCE**

This control is only effective for the sound from the main speakers.

Turn the control to adjust the balance of the output volume from the right and left main speakers to compensate for sound imbalance caused by the speaker location or listening room conditions.

**14 A/B/C/D/E**

Press this button to select one of a group (A to E) of preset stations.

**15 PRESET/TUNING**

When “>” appears on the display

This button is used to select a preset station number (1 to 8). Press > to select a higher and < to select a lower preset station number.

When “>” goes off from the display

This button is used for tuning. Press > to tune in to higher frequencies, and < to tune in to lower frequencies.

When this unit is in the PTY SEEK mode, press this button to select a program type.

**16 PRESET/TUNING, EDIT**

Press this button to turn on or off “>” on the display, and switch the function between storing a broadcasting station (preset tuning) and tuning. This button is also used to exchange the assignment of two preset stations with each other.

**17 FM/AM**

Press this button to switch the reception band between FM and AM.

**18 MEMORY (MAN’L/AUTO FM)**

Press this button to store broadcasting stations. Hold down this button for more than three seconds to begin automatic preset tuning.

**19 TUNING MODE (AUTO/MAN’L MONO)**

Press this button to switch the tuning mode between automatic and manual. To use the automatic tuning method, press this button so that the “AUTO” indicator lights up on the display. To use the manual tuning method, press this button so that the “AUTO” indicator goes off.

**20 RDS MODE/FREQ**

When an RDS station is received, press this button to change the display mode among the PS mode, PTY mode, RT mode, CT mode (if the station offers those RDS data services) and/or frequency display mode in turn.

**21 EON**

Press this button to select the desired program type (NEWS, INFO, AFFAIRS, SPORT) when you want to tune in to a radio program of that type automatically.

**22 PTY SEEK MODE**

Press this button to set the unit in the PTY SEEK mode.

**23 PTY SEEK START**

Press this button to begin searching for a station after the desired program type has been selected in the PTY SEEK mode.

**24 VIDEO AUX terminals**

Connect an auxiliary audio or video input source such as a camcorder to these terminals. If the connected video unit has an S video output terminal, connect it to the S VIDEO terminal to obtain a high-resolution picture. Use INPUT SELECTOR to select the source connected to these terminals.

## Display

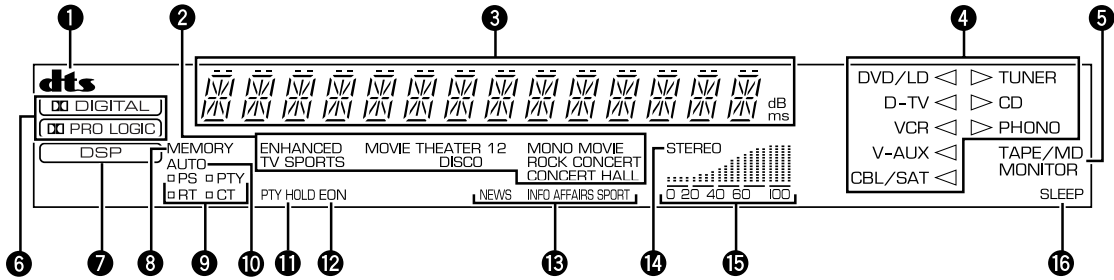

### 1 dts indicator

The “dts” indicator lights up when the built-in DTS decoder is on.

### 2 DSP program indicators

The name of the selected DSP program lights up in the following cases:

- When the tuner is selected as the input source.
- When DSP program No. 2, 3 or the subprogram “ENHANCED” of No. 1 is selected.

### 3 Multi-information display

This display shows various information: for example the name of the selected DSP program and the various settings during adjustment with the SET MENU. The current station frequency and band (FM or AM) also appear when the tuner is selected as the input source.

### 4 Input source indicators

One of the arrows for these indicators lights up depending on which source is selected.

### 5 TAPE/MD MONITOR indicator

This lights up when the tape deck or MD recorder, etc. is selected as the input source by pressing TAPE/MD MON / EXT. DECODER (or TAPE/MD).

### 6 DIGITAL and PRO LOGIC indicators

“DIGITAL” lights up when the built-in Dolby Digital decoder is on. “PRO LOGIC” lights up when the built-in Dolby Pro Logic decoder is on.

### 7 DSP indicator

“DSP” lights up when the built-in digital sound field processor is on.

### 8 MEMORY indicator

This flashes for about five seconds after pressing MEMORY. During this period, the displayed station can be stored in the memory.

### 9 RDS mode indicators

The name(s) of the RDS data offered by the currently received RDS station light(s) up. Illumination of the red indicator next to the RDS data name shows that the corresponding RDS mode is now selected.

### 10 AUTO indicator

This lights up when the unit is in the automatic tuning mode.

### 11 PTY HOLD indicator

This lights up while searching for stations in the PTY SEEK mode.

### 12 EON indicator

This lights up when an RDS station that offers the EON data service is being received.

### 13 Program type name indicators

The name of the selected program type lights up when the “EON” indicator lights up.

### 14 STEREO indicator

This lights up when an FM stereo broadcast with sufficient signal strength is being received.

### 15 Signal-level indicator

This indicates the signal level of the station being received. If multipath interference is detected, the indication decreases.

### 16 SLEEP indicator

This lights up while the built-in SLEEP timer is on.



# Remote Control

This section describes the basic operation of this unit with the remote control. First, set the selector dial to the AMP/TUN position. Refer to "PRESET REMOTE CONTROL" on page 45 for full details.

## 1 DSP

Press this button to switch the function of the numeric buttons to the DSP program selector. (Refer to page 8.)

## 2 Indicator window

This displays the name of components which can be controlled.

## 3 Numeric buttons (Input selector buttons)

These buttons select the input source.

- CD: To play a CD
- TUNER: To listen to an FM (RDS) or AM broadcast
- TAPE/MD: To play a tape or MD
- DVD/LD: To play a DVD or LD
- D-TV: To watch a TV
- VCR: To play a video cassette
- PHONO: To play an analog record
- CBL/SAT: To watch cable TV or satellite broadcast
- V-AUX: To use a camcorder
- EXT. DEC.: To play another multi-channel source

Refer to page 8 for details.

## 4 TEST

Press this button to output the test tone for each speaker.

## 5 < (left), > (right)

These buttons adjust the settings of the SET MENU and TIME/LEVEL mode.

## 6 TIME/LEVEL

Press this button to select the items in the TIME/LEVEL mode.

## 7 SLEEP

Press this button to set the SLEEP timer.

## 8 INPUT

Press this button to switch the function of the numeric buttons to the input selector. (Refer to page 8.)

## 9 Indicator

This flashes in red when pressing a button on the remote control.

## 10 Selector dial

Turn this dial to select the position for the component to be controlled. (The proper code must be set for your component. Refer to "Setup codes" on page 51.) When the position is selected, the remote control is set to that component operation mode.

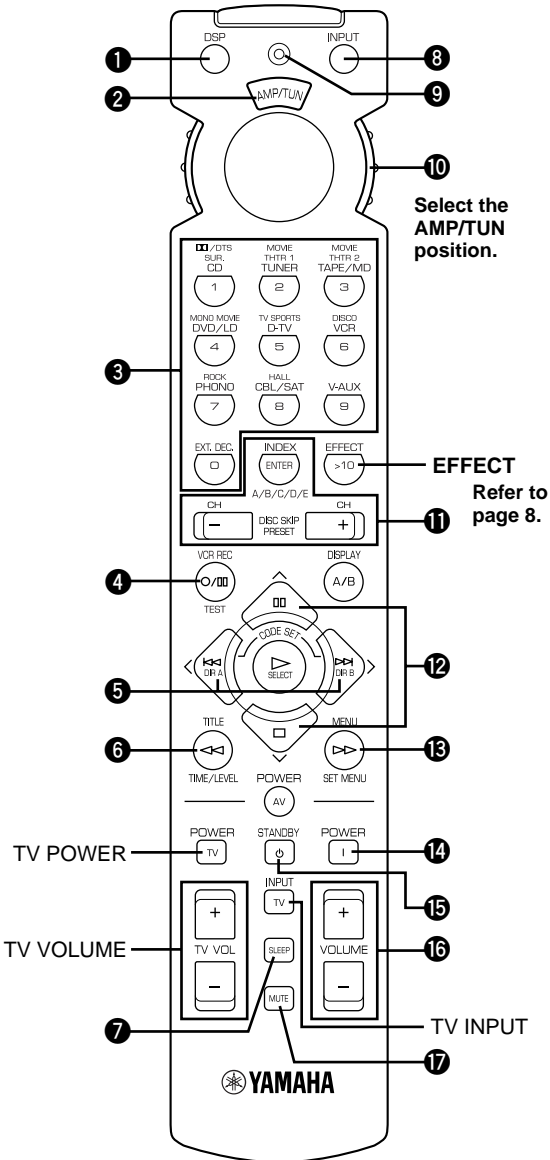

**11 A/B/C/D/E, PRESET +/-**

These buttons are used to select a preset station.

A/B/C/D/E: To select one of a group (A to E) of preset stations

PRESET +/-: To select a preset station number (1 to 8)

**12 ∨ (next), ∧ (back)**

These buttons are used to advance or go back one selection on the SET MENU and TIME/LEVEL mode.

**13 SET MENU**

Press this button to select the items on the SET MENU.

**14 POWER**

Press this button to turn this unit on.

**15 STANDBY**

Press this button to set this unit in the standby mode.

**16 VOLUME (+/-)**

These buttons are used to adjust the volume level.

**17 MUTE**

Press this button to mute the sound. To cancel mute, press this button again.

**EFFECT**

Press this button to turn on or off the effect speakers (center and rear) in the following cases:

- When the selector dial is set to the DSP/TUN position.
- While the indicator is lit for about three seconds after pressing DSP.

**Description of the Numeric Buttons**

The Numeric buttons function in various ways depending on the position of the selector dial or the combination of other instructions.

**When selecting an input source**

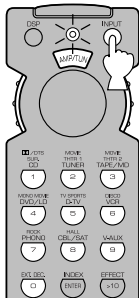

**1** Press INPUT regardless of the position of the selector dial.

The indicator lights up for about three seconds.

**2** You can select an input source with the numeric buttons while the indicator is lit.

**When selecting a DSP program and turning on or off the effect speakers (center and rear)**

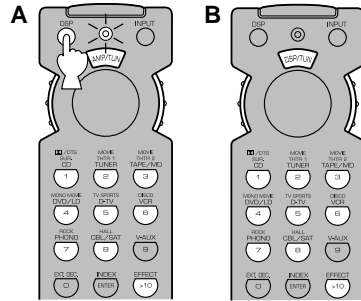

**A**

**1** Press DSP regardless of the position of the selector dial.

The indicator lights up for about three seconds.

**2** You can select a DSP program with the numeric buttons (1 to 8) and turn on or off the effect speakers (center and rear) by pressing EFFECT while the indicator is lit.

**B**

**1** Set the selector dial to the DSP/TUN position.

**2** You can select a DSP program directly with the numeric buttons (1 to 8) and turn on or off the effect speakers (center and rear) by pressing EFFECT.

**When selecting a preset station number**

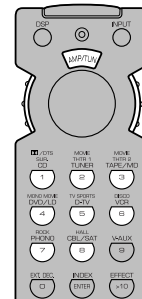

**1** Set code number "0023" in the AMP/TUN (or DSP/TUN) position.

Refer to page 51 for setting the code.

**2** Set the selector dial to the AMP/TUN (or DSP/TUN) position.

**3** You can select a preset station number directly with the numeric buttons (1 to 8).

Refer to page 29.



# SPEAKER SETUP

## Speakers to Be Used

This unit is designed to provide the best sound-field quality with a 5-speaker system, using main speakers, rear speakers and a center speaker. If you use different brands of speakers (with different tonal qualities) in your system, the tone of a moving human voice and other types of sound may not shift smoothly. We recommend that you use speakers from the same manufacture or speakers with the same tonal quality.

The main speakers are used for the main source sound plus the effect sounds. They will probably be the speakers from your present stereo system. The rear speakers are used for the effect and surround sounds, and the center speaker is for the center sounds (dialog, vocals, etc.). If for some reason it is not practical to use a center speaker, you can do without it. Best results, however, are obtained with the full system.

The main speakers should be high-performance models and have enough power-handling capacity to accept the maximum output of your audio system. The other speakers do not have to be equal to the main speakers. For precise sound localization, however, it is ideal to use high-performance models that can reproduce sounds over the full range for the center speaker and the rear speakers.

### ■ Use of a subwoofer expands your sound field

It is also possible to further expand your system with the addition of a subwoofer. The use of a subwoofer is effective not only for reinforcing bass frequencies from any or all channels, but also for reproducing the LFE (low frequency effect) channel with high fidelity when playing back a source encoded with Dolby Digital or DTS. The YAMAHA Active Servo Processing Subwoofer System is ideal for natural and lively bass reproduction.

## Speaker Placement

Refer to the following diagram when you place the speakers.

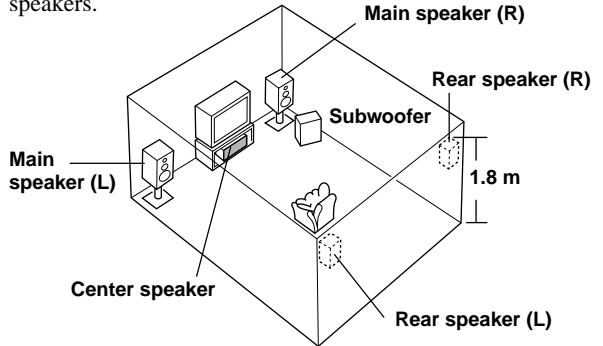

### ■ Main speakers

Place the right and left main speakers an equal distance from the ideal listening position. The distance of each speaker from each side of the TV monitor should be the same.

### ■ Rear speakers

Place these speakers behind your listening position, facing slightly inwards, nearly 1.8 m (approx. 6 feet) above the floor.

### ■ Center speaker

Align the front face of the center speaker with the front face of your TV monitor. Place the speaker as close to the monitor as possible, such as directly over or under the monitor and centrally between the main speakers.

#### Note

- If the center speaker is not used, the center channel sound will be heard from the right and left main speakers. In that case, "CENTER SP" on the SET MENU is set to the NONE position. (Refer to page 39 for details.)

### ■ Subwoofer

The position of the subwoofer is not so critical, because low bass sounds are not highly directional. But it is better to place the subwoofer near the main speakers. Turn it slightly toward the center of the room to reduce the wall reflections.

#### CAUTION

Some types of speakers interfere with a TV monitor. If this problem occurs, move the speakers away from the monitor. If you cannot avoid installing the center speaker or subwoofer near the TV monitor, use magnetically shielded speakers.



# CONNECTIONS

## Before Connecting Components

### CAUTION

Never connect this unit and other components to mains power until all connections between components have been completed.

Be sure all connections are made correctly, that is to say L (left) to L, R (right) to R, “+” to “+” and “-” to “-”. Some components require different connection methods and have different terminal names. Refer to the instructions for each component to be connected to this unit.

When you connect other YAMAHA audio components (such as a tape deck, MD recorder and CD player or changer), connect it to the terminals with the same number labels as **1**, **3**, **4** etc. YAMAHA applies this labeling system to all its products.

Use RCA-type pin plug cables for connecting audio/video components with the exception described later.

The input and output terminals for pin plugs can be distinguished as follows:

Yellow	video signals (composite)	
White	analog audio signals for the left channel	
Red	analog audio signals for the right channel	
	coaxial digital signals	

After completing all connections, check them again to make sure they are correct.

### Connecting the Antenna (pages 11 and 12)

### Connecting to an External Decoder (page 15)

### Connecting the Speakers (pages 16 and 17)

### Connecting the Power Supply Cords (page 18)

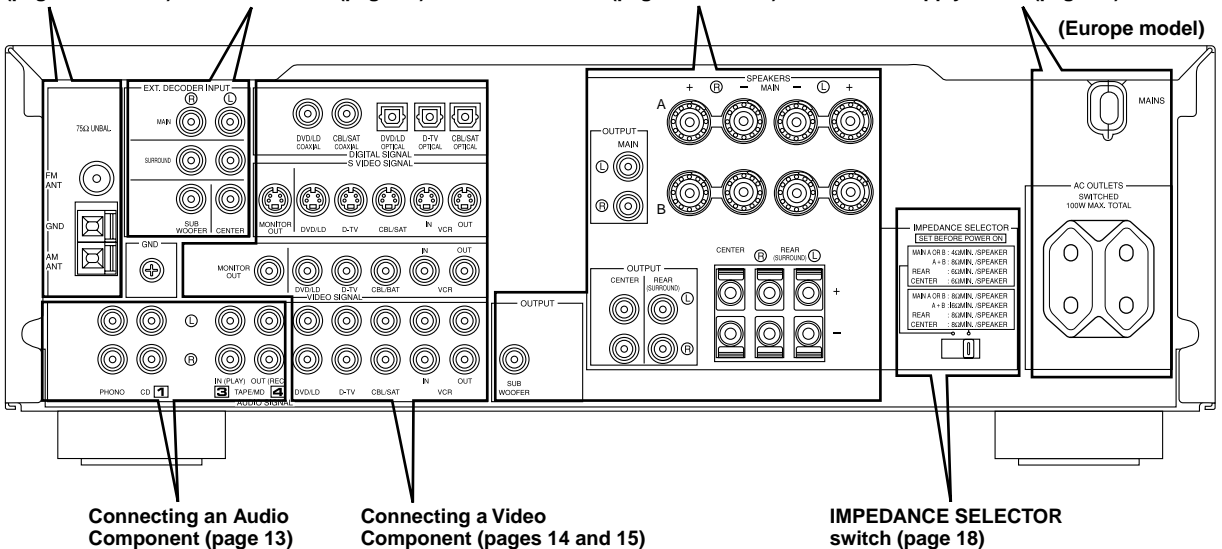

## Connecting the Antennas

Both AM and FM indoor antennas are included with this unit. In general, these antennas should provide sufficient signal strength. However, a properly installed outdoor antenna provides clearer reception than an indoor one. If you experience poor reception quality, an outdoor antenna may improve the quality.

Connect each antenna correctly to the designated terminals.

### Indoor FM antenna (included)

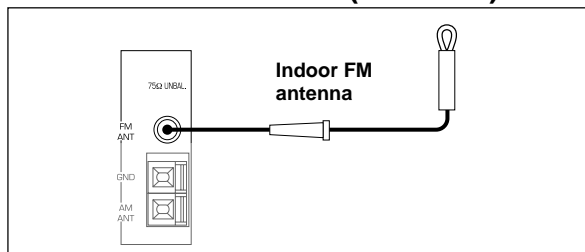

Firmly insert the connector into the FM ANT terminal. The indoor FM antenna is only a simple antenna. For reception with better sound quality, installing the outdoor FM antenna (commercially available) is recommended.

#### Note

- Do not connect an outdoor FM antenna and the indoor FM antenna at the same time.

### Outdoor FM antenna

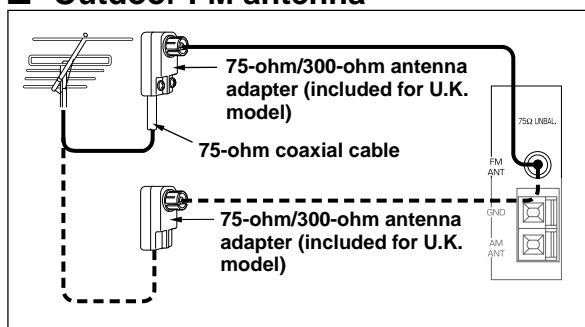

You may be unable to obtain good FM radio reception depending on your local conditions (distance from the broadcasting station, interposing buildings and mountains, etc.). Consult your dealer or authorized service center and be sure to install an antenna that suits your local conditions.

Install the outdoor FM antenna (commercially available) in a high place as far away from any roads as possible to avoid being affected by automobile ignition noise.

### Connecting a coaxial cable to the included 75-ohm/300-ohm antenna adapter (U.K. model only)

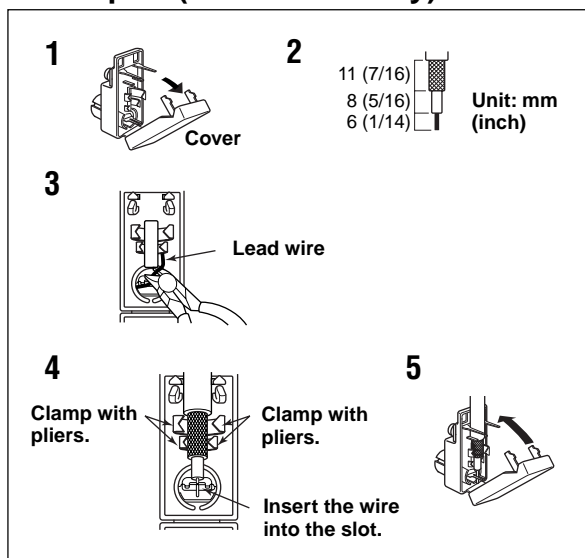

- 1 Open the cover of the included 75-ohm/300-ohm antenna adapter.
- 2 Cut the external sleeve of the 75-ohm coaxial cable and prepare it for connection.
- 3 Cut the lead wire and remove it.
- 4 Insert the cable wire into the slot, and clamp it with pliers.
- 5 Snap the cover into place.

## ■ AM loop antenna (included)

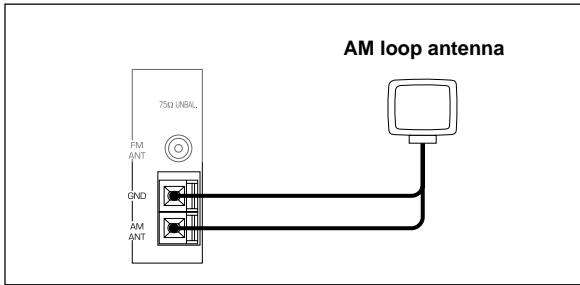

The AM loop antenna can be removed from the stand and attached to a wall, etc. However, note that the reception sensitivity may deteriorate if the antenna is attached to a metal or steel reinforced wall.

### Notes

- The AM loop antenna should be placed away from this unit.
- The AM loop antenna should always be connected, even if an outdoor AM antenna is connected to this unit.

## ■ Connecting the AM loop antenna

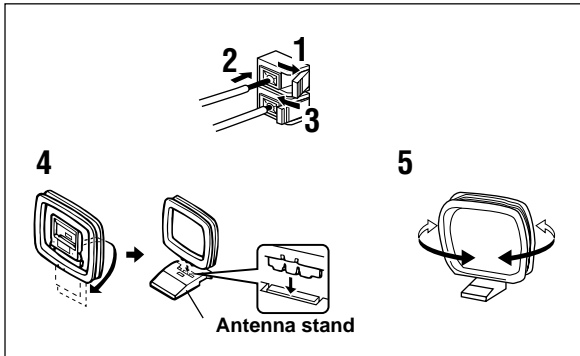

- 1** Press the tab and unlock the terminal hole.
- 2** Insert the AM loop antenna lead wires into the AM ANT and GND terminals.
- 3** Return the tab to its original position to lock the lead wires. Lightly pull the lead wires to confirm a good connection.
- 4** Attach the loop antenna to the antenna stand.
- 5** Orient the AM loop antenna so that the best reception is obtained.

## ■ Outdoor AM antenna

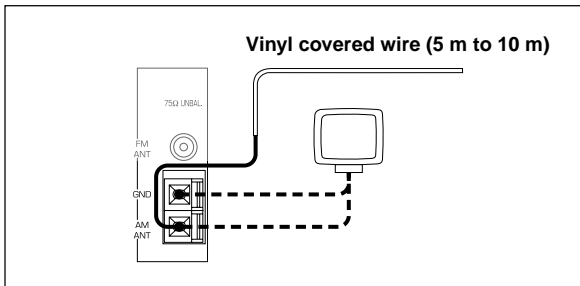

If you cannot obtain good reception with the AM loop antenna, connect 5 m to 10 m of vinyl covered wire to the AM ANT terminal and extend it outdoors from a window.

## ■ Ground (GND terminal)

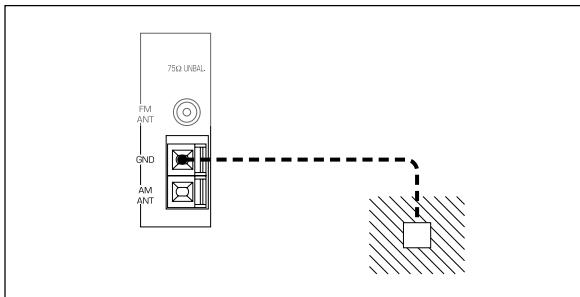

For maximum safety and minimum interference, connect the antenna GND terminal to a good earth ground. A good earth ground is a metal stake driven into moist earth.

## Connecting an Audio Component

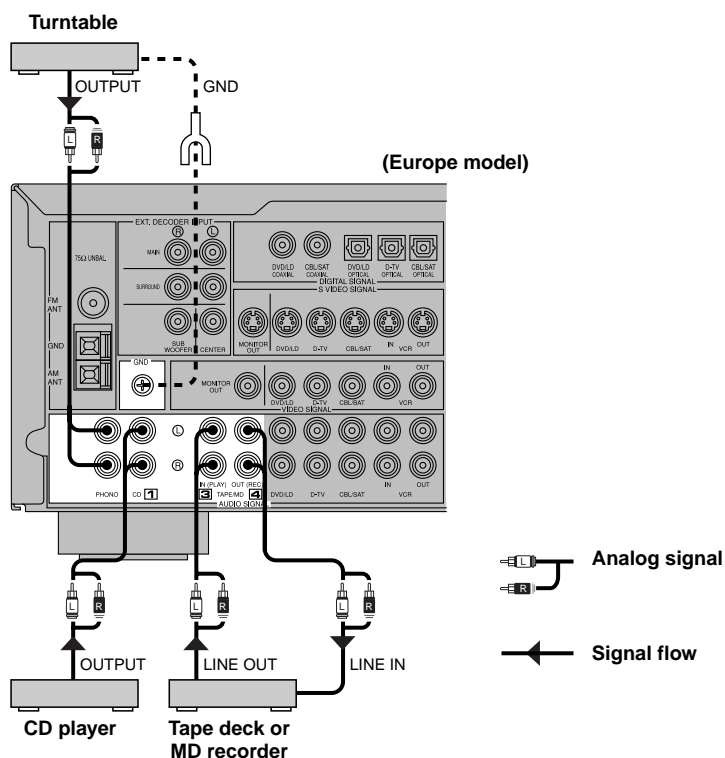

Be sure to connect the right channel (R), left channel (L), input (IN) and output (OUT) properly.

### ■ PHONO terminals

These terminals are used to connect a turntable with an MM or high-output MC cartridge. If you have a turntable with a low-output MC cartridge, use an inline boosting transformer or MC head amplifier when connecting to these terminals.



Connecting the ground (earth) wire of the turntable to the GND terminal will normally minimize hum, but in some cases, better results may be obtained with the ground wire disconnected.

## Connecting a Video Component

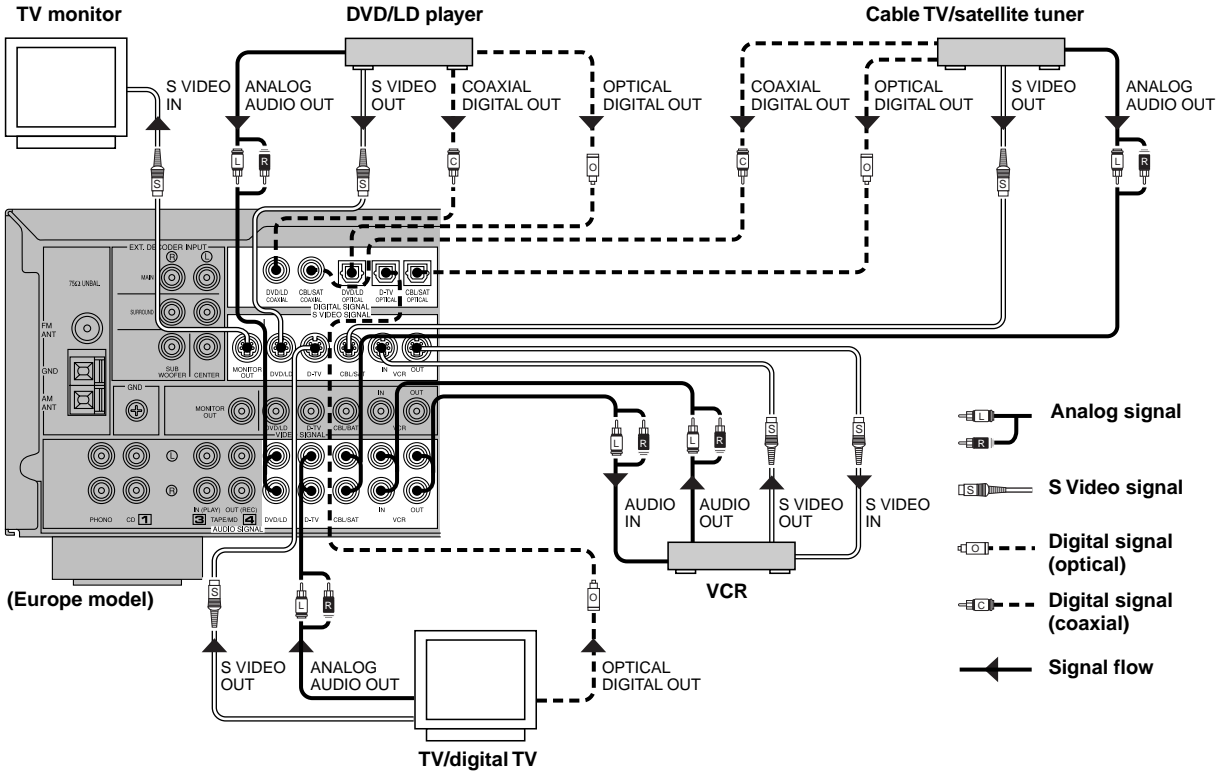

### ■ Audio signal terminals

Be sure to connect the right channel (R), left channel (L), input (IN) and output (OUT) properly.

### ■ S Video signal terminals

Use a special S VIDEO cable (commercially available) for the S VIDEO connection.

### ■ Digital audio signal terminals

If your DVD/LD player, TV/digital TV or cable TV/satellite tuner, etc. has coaxial or optical digital signal output terminals, they can be connected to this unit's COAXIAL and/or OPTICAL digital signal input terminals. To make a connection between the optical digital signal terminals, remove the cover from each terminal, and then connect them by using a commercially available optical fiber cable that conforms to EIA standards. Other cables might not function correctly.

When making connections between the digital signal terminals, you should connect the components to the same-named analog audio signal terminals of this unit, because a digital signal cannot be recorded by a tape deck, MD recorder or VCR connected to this unit.

### Notes

- Be sure to attach the covers when the OPTICAL terminals are not being used in order to protect them from dust.
- If your LD player has a Dolby Digital RF signal output terminal, be sure to use the RF demodulator (separately purchased).
- No sound will be heard when connecting your LD player's Dolby Digital RF signal output terminal directly to this unit's COAXIAL DVD/LD digital signal input terminal.



- The input signal from the DVD/LD or CBL/SAT input terminals is selected in the following order of priority with the input mode set to AUTO: COAXIAL terminal → OPTICAL terminal → Analog terminal. Refer to page 23 for details.
- All digital signal input terminals are applicable to sampling frequencies of 32 kHz, 44.1 kHz, 48 kHz and 96 kHz. (Refer to page 24 about 96-kHz sampling 24-bit digital signals.)



## VIDEO terminals (composite)

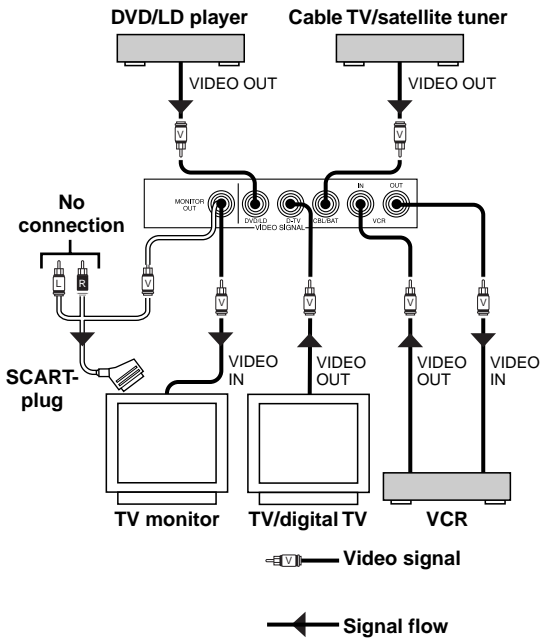

If your video components do not have “S” video terminals, they can be connected to this unit’s VIDEO terminals. Be sure to connect the input (IN) and output (OUT) properly.

### Note

- If video signals are input from both the S VIDEO input and composite input terminals, the signals will be directed to their respective output terminals.

## TV monitor with a 21-pin connector

Make a connection as shown above with a commercially available SCART-plug connector cable.

## VIDEO AUX terminals (on the front panel)

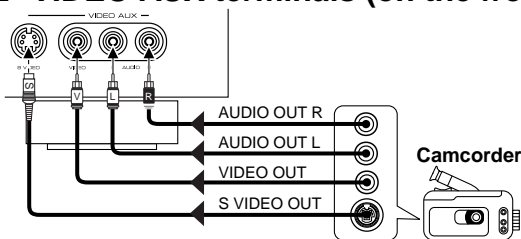

These terminals are used to connect any video input source such as a camcorder to this unit.

## Connecting to an External Decoder

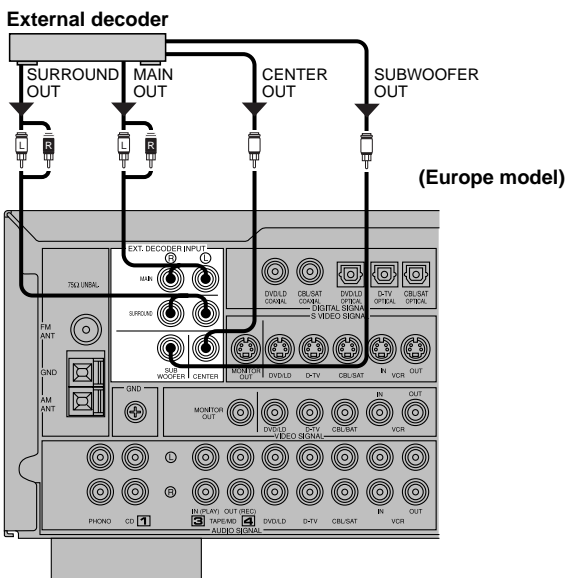

This unit has additional 6-channel audio signal input terminals for connecting an external decoder to this unit. Connect the 6-channel audio signal output terminals of the decoder to the EXTERNAL DECODER INPUT terminals of this unit.

### Notes

- When a source connected to these terminals is selected, the digital sound field processor cannot be used.
- The settings of “CENTER SP”, “REAR SP”, “MAIN SP” and “BASS OUT” on the SET MENU have no effect on a source connected to these terminals. The setting of “MAIN LVL” is effective. (Refer to pages 39 and 40 for details.)
- Adjustment of the output level of the center speaker, rear speakers and subwoofer is effective when a source connected to these terminals is selected as the input source. (Refer to page 42 for details.)

## Connecting the Speakers

### Subwoofer connection

When using a subwoofer with built-in amplifier, including the YAMAHA Active Servo Processing Subwoofer System, connect the input terminal of the subwoofer system to the SUBWOOFER OUTPUT terminal of this unit. Low bass signals distributed from the main, center and/or rear channels are directed to this terminal. (The cut-off frequency of this terminals is 90 Hz.) The LFE (low frequency effect) signals generated when Dolby Digital or DTS is decoded are also directed if they are assigned to this terminal.

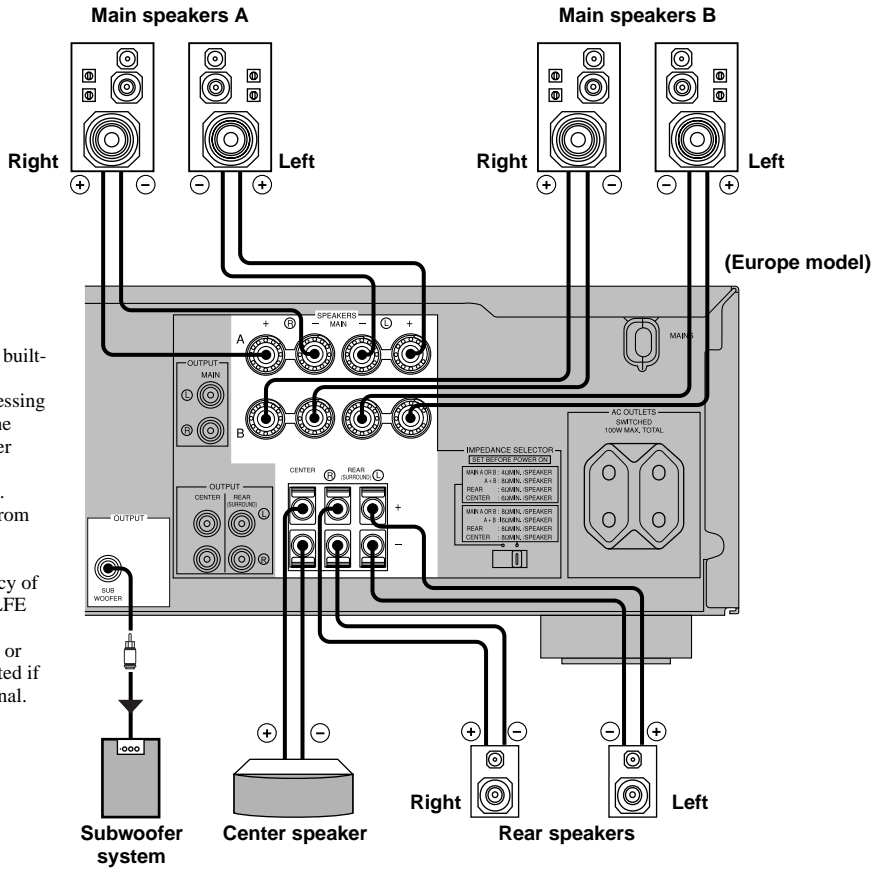

Be sure to connect the right channel (R), left channel (L), “+” (red) and “-” (black) properly. If the connections are faulty, no sound will be heard from the speakers, and if the polarity of the speaker connections is incorrect, the sound will be unnatural and lack bass.

### CAUTIONS

- Use speakers with the specified impedance shown on the rear panel of this unit.
- Do not let the bare speaker wires touch each other and do not let them touch any metal part of this unit. This could damage the unit and/or speakers.

### ■ MAIN SPEAKERS terminals

One or two speaker systems can be connected to these terminals. If you use only one speaker system, connect it to either of the SPEAKERS A or B terminals.

### ■ REAR SPEAKERS terminals

A rear speaker system can be connected to these terminals.

### ■ CENTER SPEAKER terminals

A center speaker can be connected to these terminals.

## Speaker cables

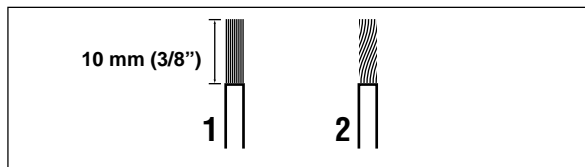

- 1** Remove approx. 10 mm (3/8") of insulation from each of the speaker cables.
- 2** Twist the exposed wires of the cable together to prevent short circuits.

## Connecting to the MAIN SPEAKERS terminals

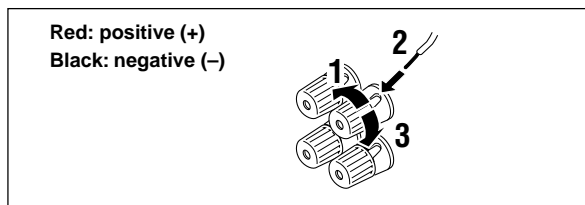

- 1** Unscrew the knob.
- 2** Insert one bare wire into the hole in the side of each terminal.
- 3** Tighten the knob to secure the wire.

## Connecting to the REAR and CENTER SPEAKERS terminals

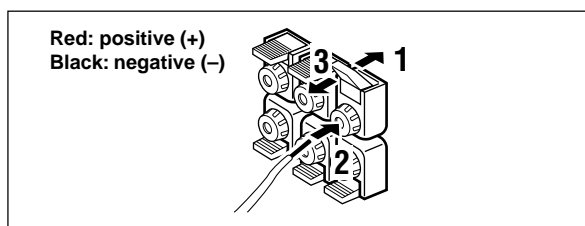

- 1** Open the tab.
- 2** Insert one bare wire into the hole of each terminal.
- 3** Return the tab to secure the wire.

## Connecting to an external amplifier

The speaker connections described on page 16 are fine for most applications. If you wish to drive your existing amplifier, the following terminals are available for connecting an external amplifier(s) to this unit.

### Note

- Output signals from these terminals are affected by the use of VOLUME, BASS, TREBLE and BALANCE.

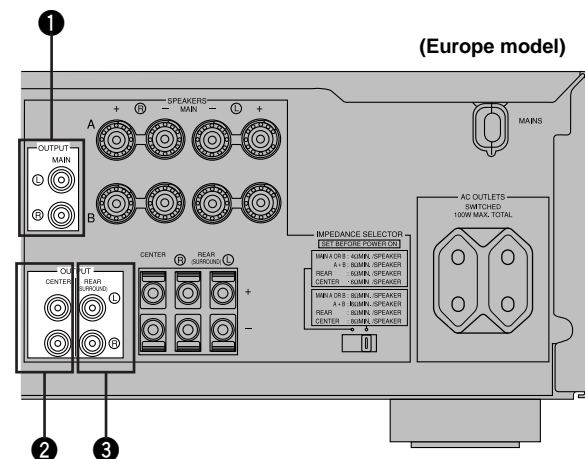

### 1 MAIN OUTPUT terminals

These terminals are for the main channel line output. Connect the input terminals of the external amplifier to these terminals.

### 2 CENTER OUTPUT terminals

These terminals are for the center channel line output. Connect the input terminals of the external amplifier to these terminals.

### 3 REAR (SURROUND) OUTPUT terminals

These terminals are for the rear channel line output. Connect the input terminals of the external amplifier to these terminals.

### Note

- If an external amplifier is connected to the MAIN, CENTER or REAR OUTPUT terminals, disconnect the corresponding speakers (main, center or rear) from the SPEAKERS terminals.

## IMPEDANCE SELECTOR Switch

### WARNING

Do not change the IMPEDANCE SELECTOR switch setting while the power of this unit is on, otherwise the unit may be damaged.

If this unit fails to turn on when STANDBY/ON (or POWER) is pressed, the IMPEDANCE SELECTOR switch may not be fully slide to either position. If so, slide the switch to either position fully when this unit is in the standby mode.

Select the right or left position according to the impedance of speakers in your system. Be sure to move this switch only when this unit is in the standby mode.

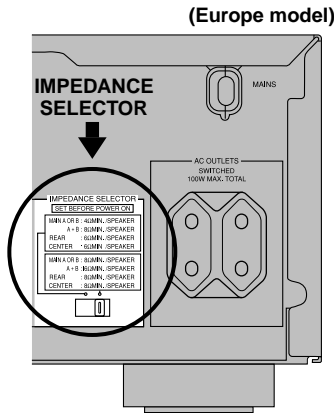

If you use	left position	right position
Main speakers	If you use one pair of main speakers, the impedance of each speaker must be 4 Ω or higher.	If you use one pair of main speakers, the impedance of each speaker must be 8 Ω or higher.
	If you use two pairs of main speakers, the impedance of each speaker must be 8 Ω or higher.	If you use two pairs of main speakers, the impedance of each speaker must be 16 Ω or higher.
Rear speakers	The impedance of each speaker must be 6 Ω or higher.	The impedance of each speaker must be 8 Ω or higher.
Center speaker	The impedance must be 6 Ω or higher.	The impedance must be 8 Ω or higher.

## Connecting the Power Supply Cords

After completing all connections, connect the AC power cord to an AC power outlet. Disconnect the AC power cord if you will not use this unit for a long period of time.

### ■ AC OUTLETS (SWITCHED)

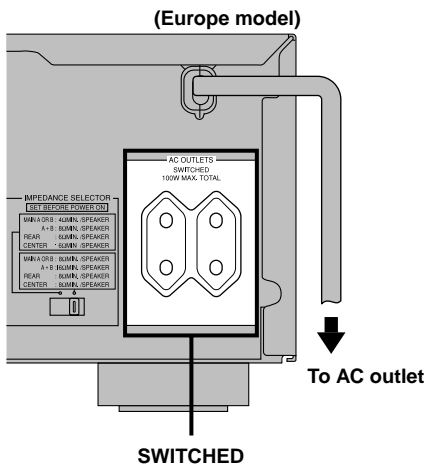

Europe model ..... 2 OUTLETS  
 U.K. model ..... 1 OUTLET  
 Use these outlets to connect the power cords from your components to this unit. The power to the AC OUTLET(S) is controlled by this unit's STANDBY/ON (or POWER and STANDBY). These outlets will supply power to any connected component whenever this unit is turned on. The maximum power (total power consumption of components) that can be connected to the AC OUTLET(S) is 100 W.



# ADJUSTING THE SPEAKER BALANCE

This procedure lets you adjust the sound output level balance between the main, center and rear speakers by using the built-in test tone generator. When this adjustment is performed, the sound output level heard at the listening position will be the same from each speaker. This is important for the best performance of the digital sound field processor, the Dolby Pro Logic decoder, Dolby Digital decoder and DTS decoder.

## Before You Start Adjusting

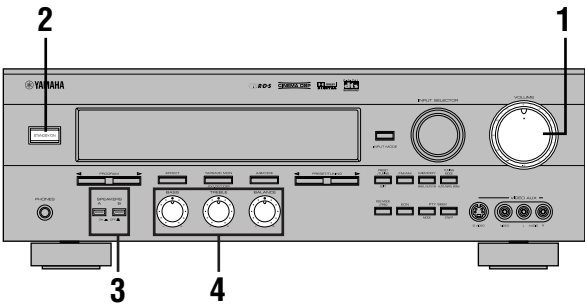

**1** Set VOLUME to the “∞” position.

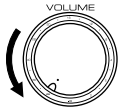

**2** Turn the power on.



**3** Press SPEAKERS A or B to select the main speakers to be used. If you use two main speaker systems, press both A and B.

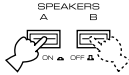

**4** Set BASS, TREBLE and BALANCE to the “0” position.



## Using the Test Tone

The adjustment of each speaker sound output level should be performed at your listening position with the remote control. After completing the adjustments, use VOLUME (+/-) at your listening position to check if the adjustments are satisfactory.

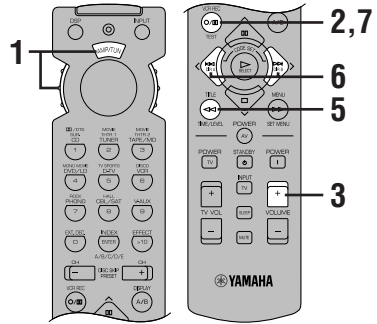

**1** Set the selector dial to the AMP/TUN (or DSP/TUN) position.



**2** Press TEST. “TEST LEFT” appears on the display.

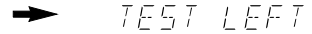

**3** Turn up the volume. You will hear a test tone (like pink noise) from each speaker for about two seconds in the following order: left main speaker, center speaker, right main speaker, right rear speaker and left rear speaker. The display changes as shown below.

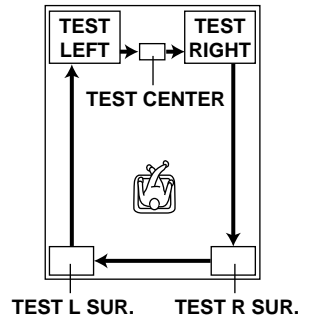
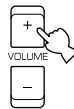

- Notes**
- If the test tone cannot be heard, turn down the volume, set the unit in the standby mode and check the speaker connections.
  - If the test tone cannot be heard from the center speaker, check the setting of “CENTER SP” on the SET MENU.

PREPARATION

English

**4** Adjust **BALANCE** on the front panel so that the sound output level of the right main speaker and the left main speaker is the same.



**5** Press **TIME/LEVEL** repeatedly to select the speaker to be adjusted. "CENTER", "R SUR." or "L SUR." appears on the display.



After pressing TIME/LEVEL once, you can also select the item by pressing  $\nabla$ . (Pressing  $\wedge$  changes the selection in the reverse order.)

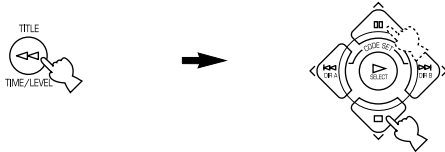

**6** Press  $\triangleright$  to raise and  $\triangleleft$  to lower the level. Adjust the sound output levels of the center speaker and the rear speakers so that they become almost the same as that of the main speakers.

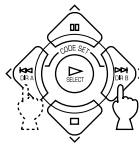

While adjusting, the test tone is heard from the selected speaker.

**Note**

- You cannot adjust the delay time while the test tone is being heard even if "DELAY" appears on the display.

**7** When the adjustment is complete, press **TEST**. "TEST OFF" appears on the display and the test tone stops.



TEST OFF

**Note**

- If "CENTER SP" on the SET MENU is set to the NONE position, the sound output level of the center speaker cannot be adjusted in step 6. The center channel sound is automatically output from the right and left main speakers.



- Once you have completed the adjustments, you can only adjust the overall volume level of your audio system by using VOLUME (or VOLUME (+/-)).
- If you use external amplifiers, you may also use their volume controls to achieve the proper balance.
- If there is insufficient sound output from the center and rear speakers, you may decrease the main speaker output level by setting "MAIN LVL" on the SET MENU to "-10 dB". (Refer to page 40 for details.)

# PLAYING A SOURCE

When using the remote control, set the selector dial to the AMP/TUN position.

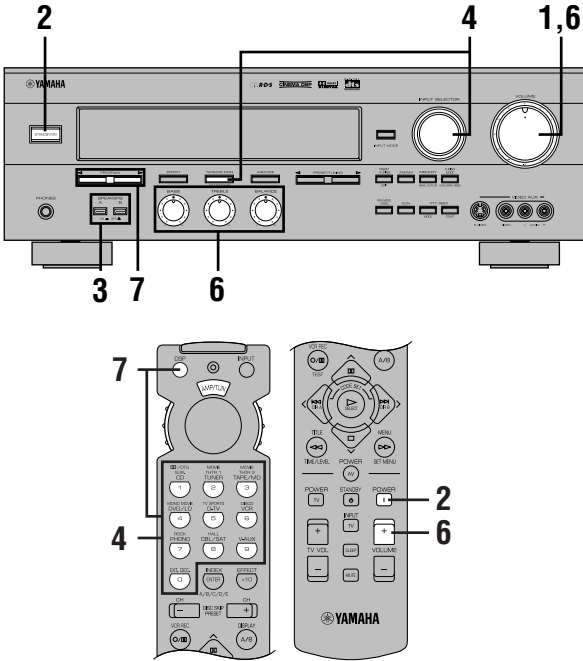

**1** Set VOLUME to the “∞” position.

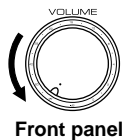

**2** Turn the power on.

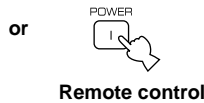

**3** Press SPEAKERS A or B to select the main speakers to be used.

If you use two main speaker systems, press both A and B.

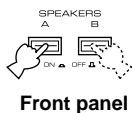

**4** Select the desired input source with INPUT SELECTOR (or the input selector buttons). (Turn on the TV monitor for video sources.)

The name of the selected input source appears for a moment and the arrow for the selected input source indicator lights up on the display.

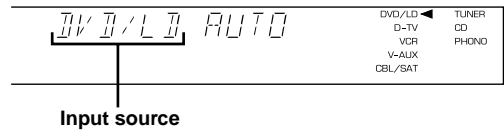
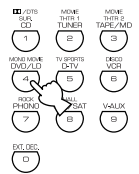
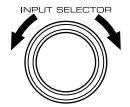

**a.** To select a tape or an MD source

Press TAPE/MD MON / EXT. DECODER (or TAPE/MD MONITOR) indicator lights up on the display.

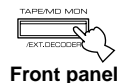

**b.** To select a source connected to the EXTERNAL DECODER INPUT terminals

Press TAPE/MD MON / EXT. DECODER repeatedly (or EXT. DEC.) until “EXT. DECODER” appears on the display.

**Notes**

- If the “TAPE/MD MONITOR” indicator lights up or “EXT. DECODER” is shown on the display, no other audio source except a tape/MD source and a source connected to the EXTERNAL DECODER INPUT terminals can be played. To select another input source with INPUT SELECTOR (or the input selector buttons):
  - Press TAPE/MD MON / EXT. DECODER twice (or TAPE/MD MON) to turn off the “TAPE/MD MONITOR” indicator.
  - Press TAPE/MD MON / EXT. DECODER once (or EXT. DEC.) to turn off “EXT. DECODER”.
- If you select and play a video source when the “TAPE/MD MONITOR” indicator lights up, the play back result will be a video image from the video source and the sound from the audio source connected to the TAPE/MD IN (PLAY) terminals.
- A video source cannot be selected when “EXT. DECODER” is shown on the display. If you want to enjoy an audio source connected to the EXTERNAL DECODER INPUT terminals together with a video source, first select the video source and then select the source connected to the EXTERNAL DECODER INPUT terminals.



For the DVD/LD, TV/digital TV and cable TV/satellite tuner sources, the current input mode is also shown. Refer to page 23 for details about the input mode.

**5 Play the source.**

Refer to the instructions for the source component (and page 27 for details about tuning).

**Note**

- When controlling an audio/video component (tape deck, MD recorder, CD player, DVD/LD player, etc.) with the remote control, set the selector dial to the appropriate position (TAPE/MD, CD, DVD/LD, etc.), corresponding to the component you want to control. Refer to "PRESET REMOTE CONTROL" on page 45.

**6 Adjust the volume to the desired output level.**

If desired, adjust BASS, TREBLE, BALANCE, etc. These controls are only effective for sound from the main speakers.

- BASS controls the low-frequency response.
- TREBLE controls the high-frequency response.
- BALANCE adjusts the balance of the output volume from the right and left main speakers.

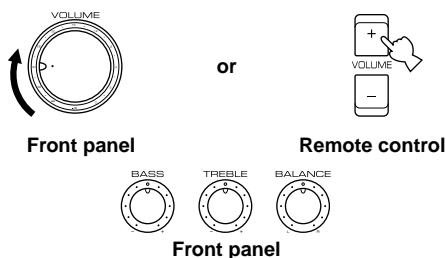
**7 Use the digital sound field processor.**

Refer to page 25.

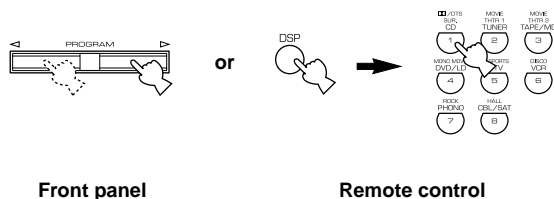
**To mute the sound**

Press **MUTE** on the remote control.



To cancel mute, press MUTE.

**Note**

- During muting, "MUTE ON" appears on the display.

**When you have finished using this unit**

Press **STANDBY/ON** (or **STANDBY**) to set this unit in the standby mode.

**BGV (background video) function**

The BGV function allows you to combine a video image from a video source with a sound from an audio source. (For example, you can listen to classical music while you are watching a video.) This function can only be controlled with the remote control.

Play a video source, and then select an audio source with the input selector buttons on the remote control. The BGV function does not work if you select the audio source with **INPUT SELECTOR** on the front panel.



## Input Mode (for the DVD/LD, TV/digital TV and cable TV/satellite tuner sources)

This unit allows you to switch the input mode for sources that send both digital and analog signals to this unit. The AUTO, DTS and ANALOG input modes are provided.

When you turn on the power of this unit, the input mode for the DVD/LD source is always set to AUTO and for TV/digital TV or cable TV/satellite tuner source is set according to “TV INPUT” and “CBL INPUT” on the SET MENU. (Refer to page 41 for details.)

### AUTO

In this mode, the input signal is selected in the following order of priority:

1. Digital signal encoded with Dolby Digital or DTS
2. Normal digital signal (PCM)
3. Analog signal (ANALOG)

#### Note

- If digital signals are input from both the OPTICAL and COAXIAL terminals, the digital signal from the COAXIAL terminal is selected.

### DTS

In this mode, only a digital signal encoded with DTS is selected, even if other signals are being input at the same time.

### ANALOG

In this mode, only an analog signal is selected, even if a digital signal is being input at the same time. Select this mode when you want to use an analog signal instead of a digital signal.

## Switching the input mode

Press INPUT MODE (or the input selector button that you have pressed to select the input source on the remote control) repeatedly until the desired input mode is shown on the display.

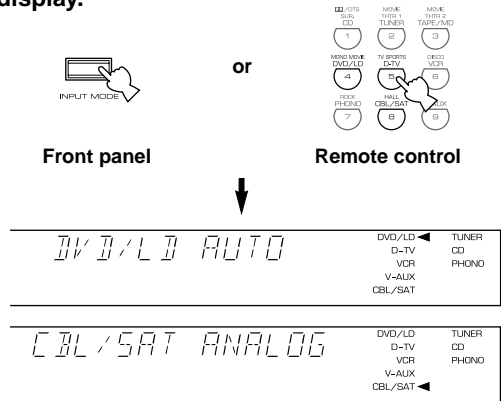

#### Notes

- Set the input mode to AUTO to play a DVD/LD source encoded with Dolby Digital.
- The sound output may be interrupted for some LD and DVD players in the following situation: The input mode is set to AUTO. A search is performed while playing the disc encoded with Dolby Digital or DTS, and then disc playing is restored. The sound output is interrupted for a moment because the digital signal was selected again.
- The input mode cannot be changed for the CD, TUNER, TAPE/MD, VCR, PHONO and VIDEO AUX sources because only analog signals are used for these.
- The current input mode appears on the display when the DVD/LD, TV/digital TV or cable TV/satellite tuner source is selected, or the input mode is changed.

## ■ Notes on playing a source encoded with DTS

- If “DATA ERROR” appears on the display while playing an LD source encoded with DTS, stop playback and turn the player off and then on again.
- If the digital output data of the player has been processed in any way, you may not be able to perform DTS decoding even if you make a digital connection between this unit and the player.
- If you play an LD source encoded with DTS and set the input mode to ANALOG, there will be the noise of an unprocessed DTS signal. When you want to play a DTS source, be sure to connect the source to the digital input terminal and set the input mode to AUTO or DTS.
- If you switch the input mode to ANALOG while playing a source encoded with a DTS signal, this unit reproduces no sound.
- If you play a source encoded with DTS and set the input mode to AUTO, there will be a short noise at first while the unit recognizes the DTS signal and turns on the DTS decoder. This is not a malfunction, and can be avoided by setting the input mode to DTS beforehand. In addition, if you continue to play a source encoded with DTS with the input mode setting left to AUTO, this unit automatically switches to the “DTS-decoding” mode to prevent noise from being generated during subsequent operation. (The “**dts**” indicator lights up on the display.) The “**dts**” indicator will flash immediately after playback of a source encoded with DTS has finished. Only a source encoded with DTS can be played back while this indicator is flashing. If you want to play a normal PCM source soon, set the input mode back to AUTO.

## ■ Notes on playing an LD source

- Some audio/video components, such as an LD player, output different audio signals through their analog and digital terminals. Change the input mode as necessary.
- If the input mode is set to AUTO for the LD source, this unit automatically determines which type of signal the LD source contains. If this unit detects a Dolby Digital or DTS signal, the decoder automatically switches to the appropriate setting and reproduces 5.1 channel sound.
- If the LD player is transmitting signals by a non-normal method, this unit cannot detect the Dolby Digital or DTS signal. In this case, the decoder automatically switches to PCM or analog.
- If the LD source does not contain a digital soundtrack, connect the LD player to the analog terminals and set the input mode to AUTO or ANALOG.
- While you are operating the LD player and playing a disc encoded with Dolby Digital, if you switch from the pause or chapter forwarding function to normal playback, you may hear the PCM or analog sound an instant before the Dolby Digital sound is played.

## ■ Notes on the digital signal

The digital input terminal of this unit can also handle 96-kHz sampling 24-bit digital signals. (To utilize this, use a source that supports 96-kHz sampling 24-bit digital signals and set the player for digital output. Refer to the instructions for the player.) Note the following when a 96-kHz sampling 24-bit digital signal is input to this unit.

1. The following indicator will appear on the display.

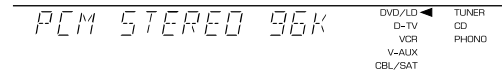

2. DSP programs cannot be selected. Sound will be output as normal 2-channel stereo sound using only the right and left main speakers.
3. Delay time and speaker output level cannot be adjusted.

# DIGITAL SOUND FIELD PROCESSOR (DSP) EFFECT

## Selecting a DSP Program

You can enhance your listening experience by selecting a DSP program. Refer to pages 35 to 37 for details about each program.

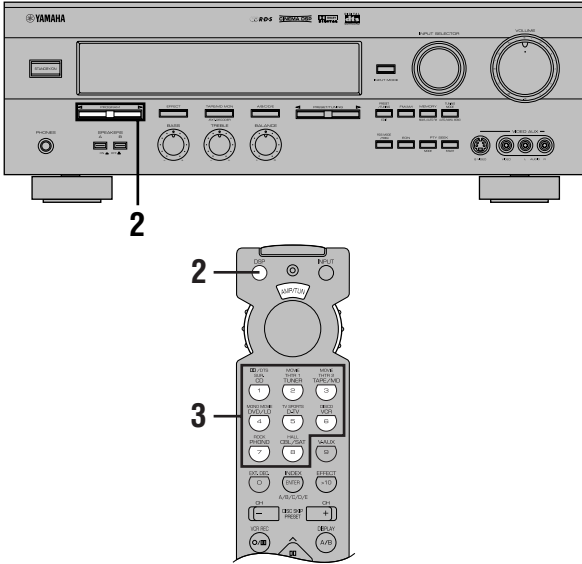

### On the remote control

**1** Make sure that the effect speakers (center and rear) and subwoofer are turned on.

**2** Press DSP.

The indicator lights up for about three seconds.



**3** Use the numeric buttons (1 to 8) to select the desired program before the indicator goes off.

The name of the selected program appears on the display.

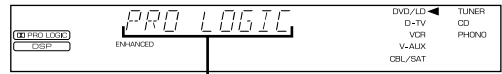
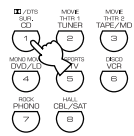

DSP program name

If the selector dial is set to the DSP/TUN position, you can select a DSP program directly with the numeric buttons.



If desired, adjust the delay time and the sound output level of each speaker. (Refer to pages 42 and 43 for details.)

### On the front panel

**1** Make sure that the effect speakers (center and rear) and subwoofer are turned on.

**2** Press PROGRAM  $\blacktriangleright$  or  $\blacktriangleleft$  repeatedly to select the desired program.

The name of the selected program appears on the display.

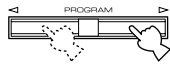

DSP program name

### Notes

- You can select a DSP program for each of the input sources. Once you select a program, it is linked with the input source selected at that time. So, when you select the input source next time, the same program is automatically selected.
- When a monaural source is being played with PRO LOGIC/Normal or PRO LOGIC/ENHANCED, no sound will be heard from the main speakers and the rear speakers. Sound can only be heard from the center speaker. However, if "CENTER SP" on the SET MENU is set to the NONE position, the center channel sound is output from the main speakers.
- When a source connected to the EXTERNAL DECODER INPUT terminals of this unit is selected, the digital sound field processor cannot be used.
- When high-rate 96-kHz sampling 24-bit digital signals are input to this unit, no DSP program can be selected and the sound is only output from right and left main speakers as a normal 2-channel stereo sound.

## Canceling the Sound Effect (turning off the effect speakers)

Press **EFFECT** to cancel the sound effect and monitor only the main sound.

Press **EFFECT** again to turn the sound effect back on.

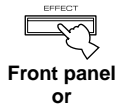

Front panel  
or



Remote control



If the selector dial is set to a position other than the DSP/TUN position, first press DSP and then EFFECT on the remote control.

### Notes

- If you turn off the sound effect when Dolby Digital or DTS is decoding, the sounds of the center and rear channels are mixed and output from the main speakers.
- If you turn off the sound effect when Dolby Digital or DTS is decoding, it may happen that the sound is output faintly or not output normally, depending on the source. In this case, turn sound effect back on.





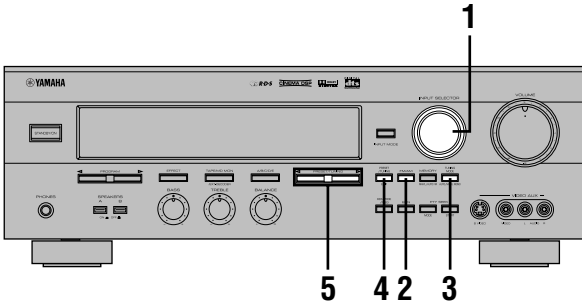

# TUNING

Automatic tuning is effective when station signals are strong and there is no interference. However, if the signal from the station you want to select is weak, you must tune in to it manually (manual tuning).

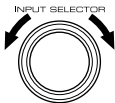

## Automatic Tuning

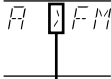
- 1 Use **INPUT SELECTOR** to select the tuner as the input source. 
- 2 Press **FM/AM** to select the reception band (FM or AM).  
“FM” or “AM” appears on the display.  → FM or AM
- 3 Press **TUNING MODE** so that the “AUTO” indicator lights up on the display.  → AUTO Lights up
- 4 Press **PRESET/TUNING (EDIT)** to turn “>” off.  →  Turn “>” off



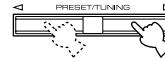

- 5 Press **PRESET/TUNING** ▷ once to tune in to a higher frequency or ◁ once to tune in to a lower frequency.

Press the button again if the tuning search does not stop at the desired station.

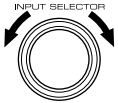

- Use the manual tuning method if the tuning search does not stop at the desired station (because the signal from the station is weak).
- When tuned in to a station, the frequency of the received station is shown on the display. If an RDS station that offers the PS data service is being received, the station name is shown instead of the frequency on the display.

## Manual Tuning

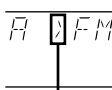
- 1 Use **INPUT SELECTOR** to select the tuner as the input source. 
- 2 Press **FM/AM** to select the reception band (FM or AM).  
“FM” or “AM” appears on the display.  → FM or AM
- 3 Press **TUNING MODE** so that the “AUTO” indicator goes off.  → AUTO Goes off
- 4 Press **PRESET/TUNING (EDIT)** to turn “>” off.  →  Turn “>” off
- 5 Press **PRESET/TUNING** ▷ or ◁ to tune in to the desired station.

To continue the tuning search, hold down the button.



### Note

- If you tune in manually to an FM station, it will be automatically received in monaural mode to increase the signal quality.

## Automatic Preset Tuning (for RDS stations only)

You can make use of the automatic preset tuning function for RDS stations only. This function enables the unit to automatically tune in with strong signals and to sequentially store up to 40 RDS stations (5 groups x 8 stations). (Refer to pages 31 to 33 for details on RDS stations.)

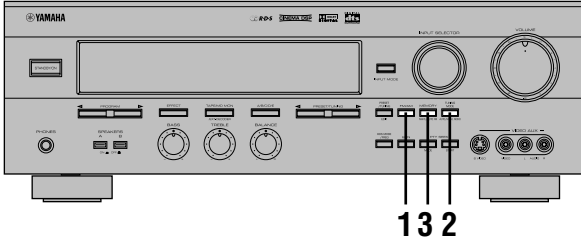

### 1 Press FM/AM to select the FM band.



### 2 Press TUNING MODE so that the "AUTO" indicator lights up on the display.



### 3 Hold down MEMORY for about three seconds.

The preset number, the "MEMORY" and "AUTO" indicators flash. After about five seconds, automatic preset tuning begins from the frequency currently displayed toward the higher frequencies.

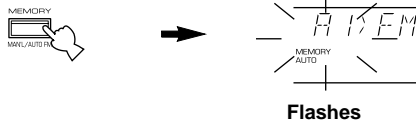

Received stations are sequentially stored as A1, A2 ... A8. If more than 8 stations have been tuned, they are stored as preset station numbers in other groups (B, C, D and E) in that order.

#### Memory back-up

The memory back-up circuit prevents the stored data from being lost when this unit is set in the standby mode. If, however, the power cord is disconnected from the AC power outlet or the power is cut for more than one week, the memory will be erased. If so, store the stations again by using preset tuning methods.

## Automatic preset tuning options

You can select the preset number from which the unit will store RDS stations and/or begin tuning toward lower frequencies. Before automatic preset tuning begins (after pressing MEMORY in step 3):

1. Press A/B/C/D/E and PRESET/TUNING > or < to select the preset number with which the first station will be stored. The automatic preset tuning will stop when stations have all been stored up to E8.
2. Press PRESET/TUNING (EDIT) to turn "}" off and then press PRESET/TUNING < to begin tuning toward lower frequencies.

## When automatic preset tuning is completed

The display shows the frequency of the last preset station. Check the contents and the number of preset stations by following the procedure in the section "To Recall a Preset Station" on page 29.

#### Notes

- A new setting can be stored in place of the former one.
- You can manually replace a preset station with another FM or AM station by simply using the manual preset tuning method.
- Automatic preset tuning will be performed for all RDS network stations until all have been stored up to E8. Even if the number of received stations is not enough to be stored up to E8, automatic preset tuning is automatically ended after searching for all stations.
- Only RDS stations with sufficient signal strength are stored by automatic preset tuning. If the station you want to store is weak in signal strength, tune in to it manually in monaural mode and store it by using the manual preset tuning method. (There may be a case that this unit cannot receive a station which could be received by using the automatic tuning method. This is because this unit receives a large amount of PI (Program Identification) data along with the station.)

## Manual Preset Tuning

You can also store up to 40 stations (5 groups x 8 stations) manually.

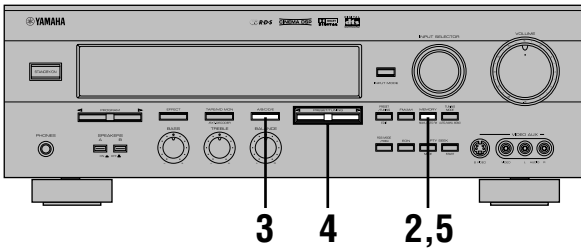

### 1 Tune in to the desired station.

Refer to page 27 for the tuning procedure.

### 2 Press MEMORY.

The “MEMORY” indicator flashes for about five seconds.

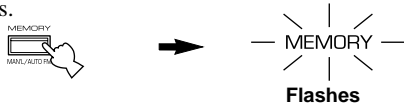

### 3 Press A/B/C/D/E repeatedly to select the desired group (A to E) of preset stations before the “MEMORY” indicator goes off.

Make sure that “>” appears on the display. The selected group appears on the display.



### 4 Press PRESET/TUNING > or < to select a preset station number (1 to 8) with which you want to store the station before the “MEMORY” indicator goes off.

Press > to select a higher preset station number and < to select a lower preset station number.

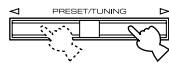

### 5 Press MEMORY before the “MEMORY” indicator goes off.

The displayed station has been stored as the preset group and number you have selected, and the reception band and frequency appear on the display.

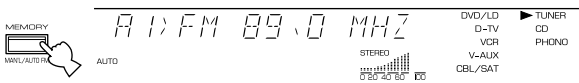

### 6 Repeat steps 1 to 5 to store other stations.

#### Notes

- A new setting can be stored in place of the former one.
- The reception mode (stereo or monaural) is stored along with the station frequency.

## To Recall a Preset Station

You can recall any desired station simply by selecting the preset station number with which it was stored.

You can also recall a preset station with the remote control. Set the selector dial to the AMP/TUN position and press TUNER (number 2) to select the tuner as the input source.

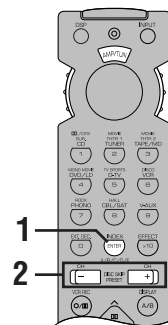
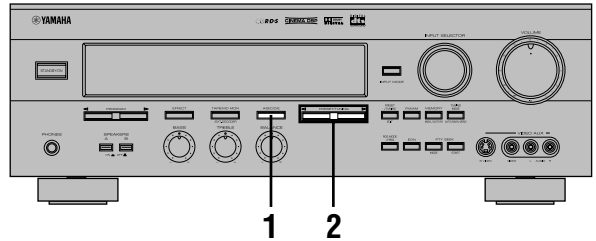

### 1 Press A/B/C/D/E to select the required group of preset stations.

Make sure that “>” appears on the display.



Front panel

Remote control

### 2 Press PRESET/TUNING > or < (or PRESET +/-) to select a preset station number (1 to 8).

The preset group and number appear on the display along with the reception band, frequency and signal strength information.

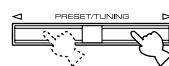

Front panel

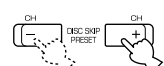

Remote control



You can select the preset station number with the numeric buttons (1 to 8) on the remote control if code number “0023” has been set in the AMP/TUN (or DSP/TUN) position.

## Exchanging Preset Stations

You can exchange the assignment of two preset stations with each other.

■ **Example: If you want to exchange preset station “E1” with “A5”**

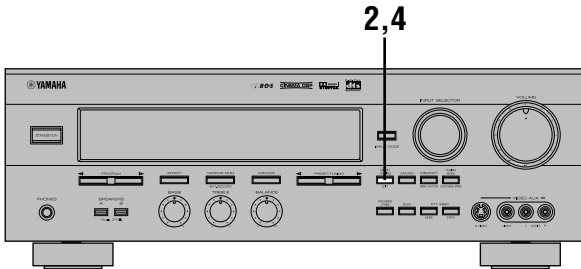

**1** Recall preset station “E1”.

Refer to the procedure in the section “To Recall a Preset Station” on page 29.

**2** Hold down (PRESET/TUNING) EDIT for about three second.

“E1” and the “MEMORY” indicator flash.

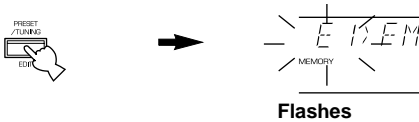

**3** Recall preset station “A5” by using the buttons on the front panel.

“A5” and the “MEMORY” indicator flash.

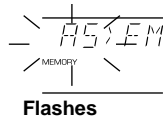

**4** Press (PRESET/TUNING) EDIT again.

The display shows the exchange of stations has been completed.

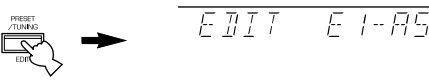





# RECEIVING RDS STATIONS

RDS (Radio Data System) is a data transmission system by FM stations in many countries. Stations using this system transmit an inaudible stream of data in addition to the normal radio signal.

RDS data contains various information such as PI (Program Identification), PS (Program Service name), PTY (Program Type), RT (Radio Text), CT (Clock Time), EON (Enhanced Other Networks), etc. The RDS function is carried out among the network stations.

## Description of RDS Data

This unit can receive PI, PS, PTY, RT, CT, and EON data when receiving RDS broadcasting stations.

### ■ PS (Program Service name) mode:

The name of the RDS station being received is displayed.

### ■ PTY (Program Type) mode:

The program type on the RDS station being received is displayed. There are 15 program types to classify RDS stations. You can make this unit search for a station which is broadcasting a program of the desired type. Refer to page 32 for details.

### ■ RT (Radio Text) mode:

Information about the program (such as the title of the song, name of the singer, etc.) on the RDS station being received is displayed by a maximum of 64 alphanumeric characters, including the umlaut symbol. If other characters are used for RT data, they are displayed with under-bars.

### ■ CT (Clock Time) mode:

The current time is displayed and updated every minute. If the data are accidentally cut off, "CT WAIT" may appear.

### ■ EON (Enhanced Other Networks):

Refer to page 33.

## Changing the RDS Mode

The four modes are available in this unit for displaying RDS data. When an RDS station is being received, PS, PTY, RT and/or CT mode indicators that correspond to the RDS data services offered by the station light up on the display. Press RDS MODE/FREQ repeatedly to change the display mode among the RDS data offered by the transmitting station in the order shown below. Illumination of the red indicator next to the RDS mode indicator shows that the corresponding RDS mode is now selected.

### Notes

- When an RDS station is being received, do not press RDS MODE/FREQ until one or more RDS mode indicators light up on the display. If you press the button before the indicators light up on the display, the mode cannot be changed. This is because the unit has not yet received all of the RDS data on the station.
- RDS data not offered by the station cannot be selected.
- The RDS data service cannot be utilized by this unit if the received signal is not strong enough. In particular, the RT mode requires a large amount of data to be received, so it is possible that the RT mode may not be displayed even if other RDS modes (PS, PTY, etc.) are displayed.
- RDS data cannot sometimes be receive under poor reception conditions. If so, press TUNING MODE so that the "AUTO" indicator goes off from the display. Although the reception mode is changed to monaural by this operation, when you change the display to RDS mode, RDS data may be displayed.
- If the signal strength is weakened by external interference during the reception of an RDS station, the RDS data service may be cut off suddenly and "...WAIT" will appear on the display.

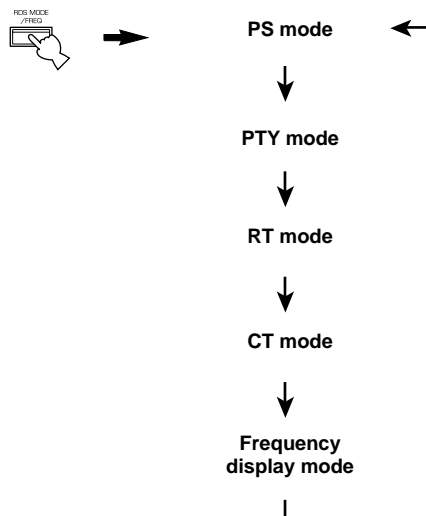

## PTY SEEK Function

If you select the desired program type, the unit automatically searches all preset RDS stations that are broadcasting a program of the required type.

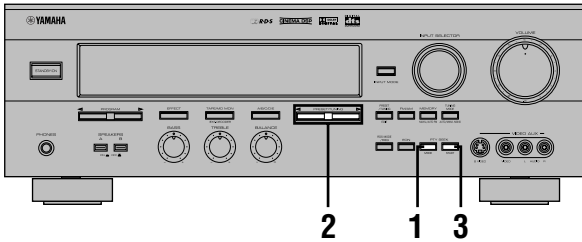

### 1 Press PTY SEEK MODE to set the unit in the PTY SEEK mode.

The program type of the station being received or “NEWS” flashes on the display.

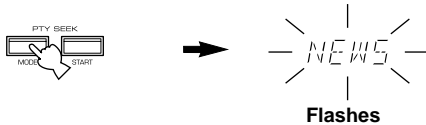

### 2 Press PRESET/TUNING > or < to select the desired program type.

The selected program type appears on the display.

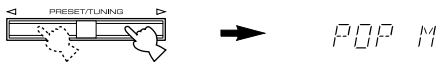

### 3 Press PTY SEEK START to begin searching all preset RDS stations.

The selected program type flashes and the “PTY HOLD” indicator lights up on the display while searching for stations.

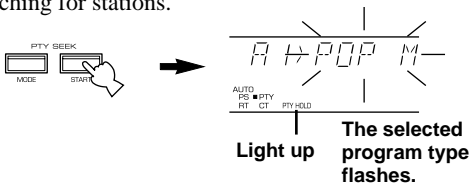

### ■ To cancel this function

Press PTY SEEK MODE twice.

### ■ Program types in the PTY mode

There are 15 program types to classify RDS stations.

NEWS	News
AFFAIRS	Current affairs
INFO	General information
SPORT	Sports
EDUCATE	Education
DRAMA	Drama
CULTURE	Culture
SCIENCE	Science
VARIED	Light entertainment
POP M	Pops
ROCK M	Rock
M.O.R. M	Middle-of-the-road music (easy-listening)
LIGHT M	Light classics
CLASSICS	Serious classics
OTHER M	Other music

## EON Function

This function uses the EON data service on the RDS station network. If you simply select the desired program type (NEWS, INFO, AFFAIRS or SPORT), the unit automatically searches for all preset RDS stations that are scheduled to broadcast a program of the required type and switches from the station being currently received to the new station when the broadcasts starts.

### Note

- This function can only be used when an RDS station that offers the EON data service is being received. When such a station is being received, the “EON” indicator lights up on the display.

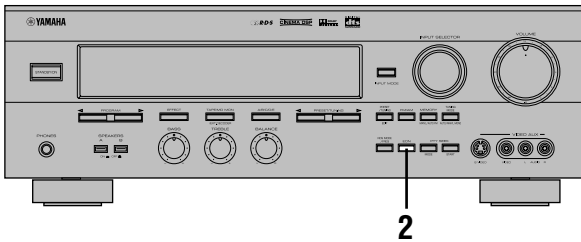

### 1 Make sure that the “EON” indicator lights up on the display.

If the “EON” indicator does not light up, tune in to another RDS station so that the “EON” indicator lights up.

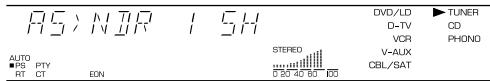

Lights up

### 2 Press EON repeatedly to select the desired program type (NEWS, INFO, AFFAIRS or SPORT).

The selected program type name indicator lights up on the display.

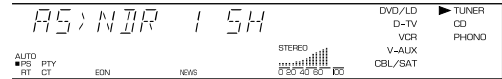

Lights up

- If a preset RDS station of the selected program type starts broadcasting, the unit will automatically switch from the program being currently received to that program. The program type name indicator flashes.

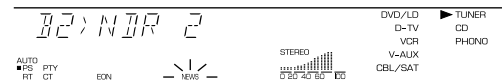

Flashes

- When broadcasting of the required program ends, the previously received station (or another program on the same station) is recalled.

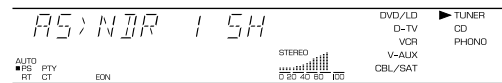

### To cancel this function

Press EON repeatedly until no program type name lights up on the display.



# RECORDING A SOURCE ON TAPE, MD OR VIDEO CASSETTE

Recording adjustments and other operations are performed from the tape deck, MD recorder or VCR. Refer to the instructions for these components.

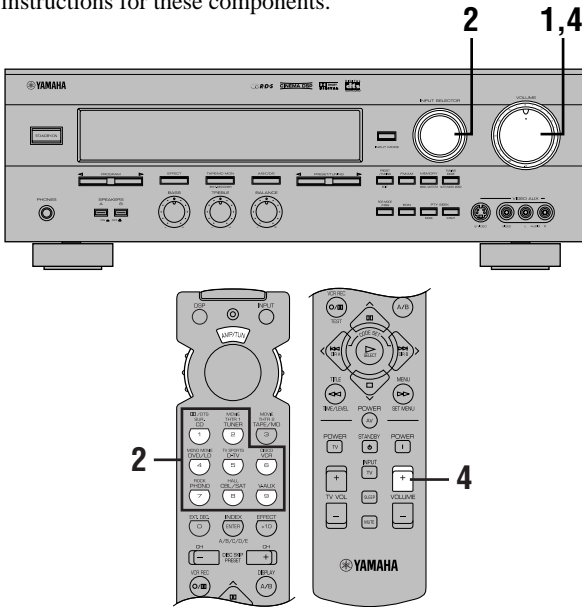

If a tape deck or MD recorder is being used for recording, you can monitor the sounds being recorded by pressing TAPE/MD MON / EXT. DECODER (or TAPE/MD).

### Notes

- The DSP program and the setting of VOLUME, BASS, TREBLE and BALANCE have no effect on the material being recorded.
- Composite video and S video signals pass independently through this unit's video circuits. Therefore, when recording or dubbing video signals, if your video source component is connected to provide only an S video (or only a composite video) signal, you can record only an S video (or only a composite video) signal by your VCR.
- A source connected to this unit only through the digital terminals cannot be recorded by the tape deck, MD recorder or VCR connected to this unit.
- A source connected to the EXTERNAL DECODER INPUT terminals of this unit cannot be recorded.
- Check the copyright laws in your country to record from records, CDs, radio, etc. Recording of copyrighted material may infringe copyright laws.

If you play back a video source that uses scrambled or encoded signals to prevent it from being dubbed, the picture itself may be disturbed due to those signals.

**1** Set VOLUME to the "∞" position.

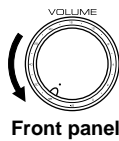

Front panel

**2** Select the source you want to record.

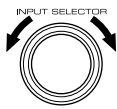

Front panel

or

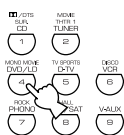

Remote control

**3** Begin recording by the tape deck, MD recorder or VCR connected to this unit.

**4** Play the source and then turn up the volume to confirm the input source.

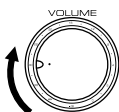

Front panel

or



Remote control



# SOUND FIELD PROGRAM

This unit incorporates a sophisticated, multi-program digital sound field processor (DSP). This processor allows you to electronically expand and change the shape of the audio sound field from both audio and video sources, creating a theater-like experience in your listening room. You can create outstanding audio sound by selecting a suitable DSP program (this will, of course, depend on what you are listening to).

When you select a CINEMA DSP program, one of the built-in decoders (Dolby Pro Logic, Dolby Digital and DTS) is turned on according to which type of signals the source being played contains.

The following list gives you a brief description of the sound fields produced by each of the DSP programs. Keep in mind that most of these are precise digital re-creations of actual acoustic environments.

- The input source given in the following table for programs 4 through 8 indicates that input source which each program is best suited for.
- Select the DSP program that you feel sounds best regardless of the name and description given for it below.

## ■ For movie or audio/video sources (Program No. 1 to No. 5: CINEMA DSP programs)

No.	PROGRAM	SUBPROGRAM	FEATURES
1	Dolby/DTS SURROUND	<b>[1] PRO LOGIC/Normal ( <input checked="" type="checkbox"/> PRO LOGIC )</b> • Input source: Dolby Surround 2-ch Dolby Digital • Output channel: 4 channels • DSP: — <b>[2] DOLBY DIGITAL/Normal ( <input checked="" type="checkbox"/> DIGITAL )</b> • Input source: Dolby Digital • Output channel: 5.1 channels • DSP: — <b>[3] DTS DGTL SUR/Normal ( <input checked="" type="checkbox"/> )</b> • Input source: DTS • Output channel: 5.1 channels • DSP: —	The built-in Dolby Pro Logic decoder, Dolby Digital decoder or DTS decoder precisely reproduces the sound and effect of a source encoded with Dolby Surround, Dolby Digital or DTS.  The realization of a highly efficient decoding process improves cross talk and channel separation, and makes sound positioning smoother and more precise.  In this program, the digital sound field processor is not turned on.
		<b>[4] PRO LOGIC/ENHANCED ( <input checked="" type="checkbox"/> PRO LOGIC <input type="checkbox"/> DSP )</b> • Input source: Dolby Surround 2-ch Dolby Digital • Output channel: 4 channels • DSP: 1 (surround) <b>[5] DOLBY DIGITAL/ENHANCED ( <input checked="" type="checkbox"/> DIGITAL <input type="checkbox"/> DSP )</b> • Input source: Dolby Digital • Output channel: 5.1 channels • DSP: 2 (surround L, R) <b>[6] DTS DGTL SUR/ENHANCED ( <input checked="" type="checkbox"/> <input type="checkbox"/> DSP )</b> • Input source: DTS • Output channel: 5.1 channels • DSP: 2 (surround L, R)	This program ideally simulates the multi-surround speaker systems of the 35 mm-film movie theater. Dolby Pro Logic decoding, Dolby Digital decoding or DTS decoding and digital sound field processing are precisely performed without altering the original sound orientation.  The surround effect produced by the sound field folds around the viewer naturally from the rear to the right and left, and toward the screen.

No.	PROGRAM	SUBPROGRAM	FEATURES
2	<b>MOVIE THEATER 1</b>	<p><b>[1] 70 mm SPECTACLE</b>  <input checked="" type="checkbox"/> PRO LOGIC <input type="checkbox"/> DSP )</p> <ul style="list-style-type: none"> <li>• Input source: Dolby Surround 2-ch Dolby Digital</li> <li>• Output channel: 3 channels</li> <li>• DSP: 2 (presence &amp; surround)</li> </ul> <p><b>[2] DGTL SPECTACLE</b>  <input checked="" type="checkbox"/> DIGITAL <input type="checkbox"/> DSP )</p> <ul style="list-style-type: none"> <li>• Input source: Dolby Digital</li> <li>• Output channel: 5.1 channels</li> <li>• DSP: 3 (presence &amp; surround L, R)</li> </ul> <p><b>[3] DTS SPECTACLE ( <b>dts</b> <input type="checkbox"/> DSP )</b></p> <ul style="list-style-type: none"> <li>• Input source: DTS</li> <li>• Output channel: 5.1 channels</li> <li>• DSP: 3 (presence &amp; surround L, R)</li> </ul>	<p>This program creates the extremely wide sound field of a movie theater. It precisely reproduces the source sound in detail, giving both the video and the sound field incredible reality. It is ideal for any kind of video source encoded with Dolby Surround, Dolby Digital or DTS (especially large-scale movie productions).</p>
		<p><b>[4] 70 mm SCI-FI ( <input checked="" type="checkbox"/> PRO LOGIC <input type="checkbox"/> DSP )</b></p> <ul style="list-style-type: none"> <li>• Input source: Dolby Surround 2-ch Dolby Digital</li> <li>• Output channel: 3 channels</li> <li>• DSP: 2 (presence &amp; surround)</li> </ul> <p><b>[5] DGTL SCI-FI ( <input checked="" type="checkbox"/> DIGITAL <input type="checkbox"/> DSP )</b></p> <ul style="list-style-type: none"> <li>• Input source: Dolby Digital</li> <li>• Output channel: 5.1 channels</li> <li>• DSP: 3 (presence &amp; surround L, R)</li> </ul> <p><b>[6] DTS SCI-FI ( <b>dts</b> <input type="checkbox"/> DSP )</b></p> <ul style="list-style-type: none"> <li>• Input source: DTS</li> <li>• Output channel: 5.1 channels</li> <li>• DSP: 3 (presence &amp; surround L, R)</li> </ul>	<p>Clearly reproduces dialog and sound effects in the latest sound form of science fiction films, thus creating a broad and expansive cinematic space amid the silence. You can enjoy science fiction films in a virtual-space sound field that includes Dolby Surround, Dolby Digital and DTS-encoded software employing the most advanced techniques.</p>
3	<b>MOVIE THEATER 2</b>	<p><b>[1] 70 mm ADVENTURE</b>  <input checked="" type="checkbox"/> PRO LOGIC <input type="checkbox"/> DSP )</p> <ul style="list-style-type: none"> <li>• Input source: Dolby Surround 2-ch Dolby Digital</li> <li>• Output channel: 3 channels</li> <li>• DSP: 2 (presence &amp; surround)</li> </ul> <p><b>[2] DGTL ADVENTURE</b>  <input checked="" type="checkbox"/> DIGITAL <input type="checkbox"/> DSP )</p> <ul style="list-style-type: none"> <li>• Input source: Dolby Digital</li> <li>• Output channel: 5.1 channels</li> <li>• DSP: 3 (presence &amp; surround L, R)</li> </ul> <p><b>[3] DTS ADVENTURE ( <b>dts</b> <input type="checkbox"/> DSP )</b></p> <ul style="list-style-type: none"> <li>• Input source: DTS</li> <li>• Output channel: 5.1 channels</li> <li>• DSP: 3 (presence &amp; surround L, R)</li> </ul>	<p>Ideal for precisely reproducing the sound of the newest multi-track films. The sound field is made to be similar to that of the newest movie theaters, so the reverberations of the sound field itself are restrained as much as possible. The data for the sound field of an opera house are used for the front presence, so the three-dimensional feeling of the sound field is emphasized, and dialog is precisely oriented on the screen. By using the data for the sound field of a concert hall on the surround sound field, powerful reverberations are generated. You can enjoy watching action, adventure movies, etc. with strong presence.</p>
		<p><b>[4] 70 mm GENERAL ( <input checked="" type="checkbox"/> PRO LOGIC <input type="checkbox"/> DSP )</b></p> <ul style="list-style-type: none"> <li>• Input source: Dolby Surround 2-ch Dolby Digital</li> <li>• Output channel: 3 channels</li> <li>• DSP: 2 (presence &amp; surround)</li> </ul> <p><b>[5] DGTL GENERAL ( <input checked="" type="checkbox"/> DIGITAL <input type="checkbox"/> DSP )</b></p> <ul style="list-style-type: none"> <li>• Input source: Dolby Digital</li> <li>• Output channel: 5.1 channels</li> <li>• DSP: 3 (presence &amp; surround L, R)</li> </ul> <p><b>[6] DTS GENERAL ( <b>dts</b> <input type="checkbox"/> DSP )</b></p> <ul style="list-style-type: none"> <li>• Input source: DTS</li> <li>• Output channel: 5.1 channels</li> <li>• DSP: 3 (presence &amp; surround L, R)</li> </ul>	<p>This program is for reproducing sounds on a multi-track film, and is characterized by a soft and extensive sound field. The front presence of the sound field is relatively narrow. It spatially spreads all around and toward the screen, restraining echo effect of conversations without losing clarity. For the surround sound field, the harmony of music or chorus sounds beautifully in a wide space at the rear of the sound field.</p>

No.	PROGRAM	FEATURES
4	<b>MONO MOVIE</b> ( <input type="checkbox"/> DSP ) <ul style="list-style-type: none"> <li>• Input source: Monaural</li> <li>• Output channel: 1 channel</li> <li>• DSP: 1</li> </ul>	This program is designed specifically to enhance monaural sources. Compared to a strictly mono setting, the sound image is wider and slightly forward of the speaker pair, lending an immediacy to the overall sound. It is particularly effective for old mono movie, news broadcasts and dialog.
5	<b>TV SPORTS</b> ( <input type="checkbox"/> DSP ) <ul style="list-style-type: none"> <li>• Input source: Audio/Video</li> <li>• Output channel: 2 to 5.1 channels</li> <li>• DSP: 2 to 3 (presence &amp; surround)</li> </ul>	This program is furnished with a tight sound field in which the sound will not spread excessively at the front, but the rear surround produces dynamic sound expansion. It is the most suitable for sports programs.

## ■ For Hi-Fi audio sources

No.	PROGRAM	FEATURES
6	<b>DISCO</b> ( <input type="checkbox"/> DSP ) <ul style="list-style-type: none"> <li>• Input source: 2-ch PCM/Analog audio</li> <li>• Output channel: 2 channels</li> <li>• DSP: 1</li> </ul>	This program simulates the acoustic environment of a disco in the heart of a lively city. The sound is dense and highly concentrated.
7	<b>ROCK CONCERT</b> ( <input type="checkbox"/> DSP ) <ul style="list-style-type: none"> <li>• Input source: 2-ch PCM/Analog audio</li> <li>• Output channel: 2 channels</li> <li>• DSP: 1</li> </ul>	This program is ideally suited for rock music. You will experience a dynamic and lively sound field.
8	<b>CONCERT HALL</b> ( <input type="checkbox"/> DSP ) <ul style="list-style-type: none"> <li>• Input source: 2-ch PCM/Analog audio</li> <li>• Output channel: 2 channels</li> <li>• DSP: 1</li> </ul>	This program creates the expansive ambience of a large concert hall. It is suited for orchestra and opera music.

## CINEMA DSP: Dolby Surround + DSP/Dolby Digital + DSP/DTS + DSP

### ■ Dolby Pro Logic + 2 digital sound fields

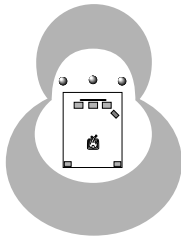

Digital sound fields are created in both the presence and rear surround zones of the Dolby Pro Logic-decoded sound field. They create a wide acoustic environment and emphasize the surround effect in the room, letting you feel as much presence as if you were watching a movie in a popular Dolby Stereo theater.

### ■ Dolby Digital or DTS + 3 digital sound fields

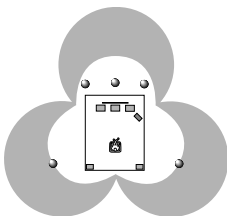

Digital sound fields are created in the presence zone and independently on the left and right surround zones of the Dolby Digital-decoded or DTS-decoded sound field. They create a wide acoustic environment and strong surround effect in the room without losing high channel separation. With the wide dynamic range of Dolby Digital or DTS sound, this sound field combination lets you feel as if you were watching a movie in the newest Dolby Digital theater or DTS-installed theater. This is the most ideal home theater sound at the present time.



# SET MENU

This unit provides you with the following items on the SET MENU to maximize the performance of your system and expand your enjoyment for audio listening and video watching.

1. CENTER SP
2. REAR SP
3. MAIN SP
4. BASS OUT
5. MAIN LVL
6. D.D. LFE
7. D-RANGE
8. DTS LFE
9. CNTR DELAY
10. MEM. GUARD
11. TV INPUT
12. CBL INPUT

## Adjusting Items on the SET MENU

Adjustments should be performed with the remote control while watching the information on the display.

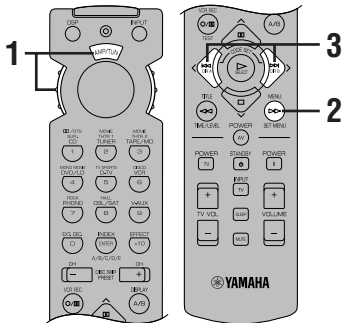

- 1** Set the selector dial to the AMP/TUN (or DSP/TUN) position.



- 2** Press SET MENU repeatedly to select the item you want to adjust.

The selected item appears on the display.

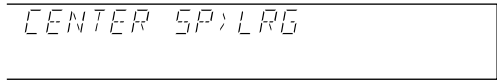

After pressing SET MENU once, you can also select the item by pressing ∨. (Pressing ∧ goes back one selection.)

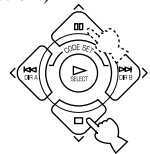

- 3** Press > or < repeatedly to adjust the setting.

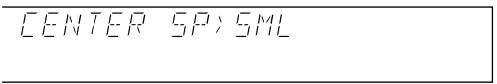
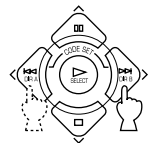

- 4** Repeat steps 2 and 3 to adjust the setting of any other item in the same way.

### Memory back-up

The memory back-up circuit prevents the stored data from being lost when this unit is set in the standby mode. If, however, the power cord is disconnected from the AC power outlet or the power is cut for more than one week, the settings of the SET MENU will automatically return to the preset positions and values. If so, adjust the settings of the SET MENU again.



## Description of Each Item

### 1. CENTER SP

Choices: LRG (Large)/SML (Small)/NONE

Preset position: LRG (Large)

CENTER SP>LRG

#### LRG (Large)

Select this position if your center speaker is approximately the same size as the main speakers. In this position, full-range signals on the center channel are directed to the center speaker.

#### SML (Small)

Select this position if you use a center speaker that is smaller than the main speakers. In this position, low bass signals (below 90 Hz) on the center channel are distributed to the SUBWOOFER OUTPUT terminal (or to the right and left main speakers if "BASS OUT" is set to the MAIN position).

#### NONE

Select this position if you do not have a center speaker (4-speaker system). In this position, full-range signals on the center channel are directed to the right and left main speakers.

### 2. REAR SP

Choices: LARGE/SMALL

Preset position: LARGE

REAR SP>LARGE

#### LARGE

Select this position if your rear speakers have high ability for bass reproduction, or if a subwoofer is connected in parallel to the rear speaker. In this position, full-range signals on the rear channels are directed to the rear speakers.

#### SMALL

Select this position if your rear speakers do not have high ability for bass reproduction. In this position, low bass signals (below 90 Hz) on the rear channels are distributed to the SUBWOOFER OUTPUT terminal (or to the right and left main speakers if "BASS OUT" is set to the MAIN position).

### 3. MAIN SP

Choices: LARGE/SMALL

Preset position: LARGE

MAIN SP>LARGE

#### LARGE

Select this position if your main speakers have high ability for bass reproduction. In this position, full-range signals on the main channels are directed to the right and left main speakers.

#### SMALL

Select this position if your main speakers do not have high ability for bass reproduction. However, if your system does not include a subwoofer, do not select this position. In this position, low bass signals (below 90 Hz) on the main channels are distributed to the SUBWOOFER OUTPUT terminal if "BASS OUT" is set to the SW position.

### 4. BASS OUT

Choices: SW/MAIN/BOTH

Preset position: BOTH

BASS OUT>BOTH

#### SW/BOTH

Select either the SW or BOTH position if your system includes a subwoofer. In either position, signals on the LFE channel and low bass signals (below 90 Hz) on the center and rear channels are directed to the SUBWOOFER OUTPUT terminal if "CENTER SP" is set to the SML or NONE position and "REAR SP" is set to the SMALL position. In the SW position, low bass signals on the main channels are directed to the SUBWOOFER OUTPUT terminal if "MAIN SP" is set to the SMALL position. In the BOTH position, low bass signals on the main channels are directed to both the main speakers and the SUBWOOFER OUTPUT terminal.

#### Note

- When playing a 2-channel source (tape, MD, CD, video cassette etc.), select the BOTH position to direct low bass signals (below 90 Hz) to the SUBWOOFER OUTPUT terminal.

#### MAIN

Select this position if your system does not include a subwoofer. In this position, besides full-range signals on the main channels, signals on the LFE channel and other low bass signals (below 90 Hz) that are distributed from other channels are directed to the right and left main speakers.

## 5. MAIN LVL

Choices: NORM (Normal)/-10 dB

Preset position: NORM (Normal)

MAIN LVL > NORM

### NORM (Normal)

Normally select this position.

### -10 dB

Select this position if the sound output from the main speakers is too loud and cannot be balanced with the sound output from the center and rear speakers. In this position, the sound output from the main speakers is attenuated.

### Notes

- The setting of “CENTER SP”, “REAR SP”, “MAIN SP” and “BASS OUT” have no effect on a source connected to the EXTERNAL DECODER INPUT terminals on the rear of this unit.
- Once you have adjusted appropriately for “CENTER SP”, “REAR SP”, “MAIN SP”, “BASS OUT” and “MAIN LVL”, you do not have to change any settings unless your speaker system is modified.

## 6. D.D. LFE (Adjusting the output level of the LFE channel for Dolby Digital)

Control range: -20 dB to 0 dB (in 1 dB steps)

Preset value: 0 dB

D \ D \ LFE 0.0

### Note

- This adjustment is only effective when Dolby Digital is being decoded and the selected source encoded with Dolby Digital contains LFE signals.

This adjusts the output level of the LFE channel. If the LFE signals are mixed with signals of other channels and they are directed to the same speakers, the ratio of the LFE signal level to the level of the other signals can be adjusted.

## 7. D-RANGE (Adjusting the dynamic range)

Choices: MAX/STD (Standard)/MIN

Preset position: MAX

D-RANGE > MAX

### Note

- This adjustment is only effective when Dolby Digital is being decoded.

“Dynamic range” is the difference between the maximum level and the minimum level of sounds. Sounds on a movie originally designed for movie theaters feature a very wide dynamic range. Dolby Digital technology can modify the original sound track into a home audio format with this wide dynamic range unchanged. Powerful sounds of extremely wide dynamic range are not always suitable for home use. Depending on the condition of your listening environment, it may not be possible to increase the sound output to a level as high as that in a movie theater. However, at the normal level suitable for listening in your room, the low-level parts of source sound often cannot be heard well because they will be lost among noise in your environment. Dolby Digital technology has also made it possible to reduce an original sound track’s dynamic range for a home audio format by “compressing” the sound data.

### MAX

In this position, a source encoded with Dolby Digital is reproduced in the original sound track’s wide dynamic range to provide you with powerful sounds just like those in a movie theater. Selecting this position will be even better if you can listen to a source at a high output level in a room specially soundproofed for audio/video enjoyment.

### STD (Standard)

In this position, a source encoded with Dolby Digital is reproduced in the “compressed” dynamic range of the source that is suitable for low-level listening.

### MIN

In this position, the dynamic range is more reduced than in the STD position. Selecting this position will be effective when you must listen to a source at a low level.

### Note

- It may happen that sound is output faintly or not output normally depending on the source. In that case, select the MAX or STD position.

## 8. DTS LFE (Adjusting the output level of the LFE channel for DTS)

Control range: -10 dB to +10 dB (in 1 dB steps)

Preset value: 0 dB

DTS LFE 0<sup>dB</sup>

### Note

- This adjustment is effective only when DTS is being decoded and the selected source encoded with DTS contains LFE signals.

This adjusts the output level of the LFE channel. If the LFE signals are mixed with signals of other channels and they are directed to the same speakers, the ratio of the LFE signal level to the level of the other signals can be adjusted.

## 9. CNTR DELAY (Adjusting the delay of the sound from the center speaker)

Control range: 0 ms to 5 ms (in 1 ms steps)

Preset value: 0 ms

CNTR DELAY 0<sub>ms</sub>

This adjusts the delay between the main sound (on the main channels) and dialog, etc. (on the center channel). The larger the value, the later the dialog, etc. is generated.

This makes sounds from the left main, center and right main speakers reach your listening position at the same time. This is achieved by delaying the sound from the center speaker if the distance from the center speaker to your listening position is shorter than the distance from the right and left main speaker to your listening position.

## 10. MEM. GUARD (Locking the settings)

Choices: ON/OFF

Preset position: OFF

MEM. GUARD OFF

If you wish to prevent accidental alterations to the settings of the SET MENU and other adjustments on this unit, select the ON position. The following settings on this unit can be locked:

- Settings of other items on the SET MENU
- Settings in the TIME/LEVEL mode
- Settings when using TEST

## 11. TV INPUT (Selecting the initial input mode for a source connected to the D-TV input terminals)

Choices: AUTO/LAST

Preset position: AUTO

TV INPUT AUTO

The input mode for a source connected to the D-TV input terminals of this unit can be automatically set when the power of this unit is turned on. Refer to page 23 for details about the input mode.

### AUTO

In this position, the input mode is always set to AUTO.

### LAST

In this position, the input mode is automatically set to that selected the last time when the power of this unit was turned on.

## 12. CBL INPUT (Selecting the initial input mode for a source connected to the CBL/SAT input terminals)

Choices: AUTO/LAST

Preset position: AUTO

CBL INPUT AUTO

The input mode for a source connected to the CBL/SAT input terminals of this unit can be automatically set when the power of this unit is turned on. Refer to page 23 for details about the input mode.

### AUTO

In this position, the input mode is always set to AUTO.

### LAST

In this position, the input mode is automatically set to that selected the last time when the power of this unit was turned on.



## DELAY TIME AND SPEAKER OUTPUT LEVELS

When using the digital sound field processor with the Dolby Pro Logic decoder, Dolby Digital decoder or DTS decoder, you can adjust the delay time between the main sound and sound effect, and each speaker's output level as you wish.

### Note

- When high-rate 96-kHz sampling 24-bit digital signals are input to this unit, the delay time and speaker output levels cannot be adjusted.

## Delay Time

You can adjust the time difference between the beginning of the sound from the main speakers and the beginning of the sound effect from the rear speakers. The larger the value, the later the sound effect is generated. The delay time can be individually adjusted to all DSP programs.

### Notes

- Adding too much delay will cause an unnatural effect with some sources.
- The sound is momentarily interrupted while adjusting the delay time.

	Program	Control range (ms)	Preset value
1.	PRO LOGIC/Normal	15 to 30	20
	DOLBY DIGITAL/Normal	0 to 15	5
	DTS DGTL SUR/Normal	0 to 15	5
	PRO LOGIC/ENHANCED	15 to 30	20
	DOLBY DIGITAL/ENHANCED	0 to 15	5
	DTS DGTL SUR/ENHANCED	0 to 15	5
2.	70 mm SPECTACLE	15 to 30	23
	DGTL SPECTACLE	1 to 99	15
	DTS SPECTACLE	1 to 99	15
	70 mm SCI-FI	15 to 30	20
	DGTL SCI-FI	1 to 99	16
	DTS SCI-FI	1 to 99	16
3.	70 mm ADVENTURE	15 to 30	20
	DGTL ADVENTURE	1 to 99	15
	DTS ADVENTURE	1 to 99	15
	70 mm GENERAL	15 to 30	20
	DGTL GENERAL	1 to 99	15
	DTS GENERAL	1 to 99	15
4.	MONO MOVIE	1 to 99	49
5.	TV SPORTS	1 to 99	9
6.	DISCO	1 to 99	40
7.	ROCK CONCERT	1 to 99	16
8.	CONCERT HALL	1 to 99	44

## Sound Output Level of the Center, Right Rear and Left Rear Speakers, and Subwoofer

If desired, you can adjust the sound output level of each speaker even if it has already been adjusted in "ADJUSTING THE SPEAKER BALANCE" on pages 19 and 20.

### Notes

- The sound output level of the center speaker cannot be adjusted when the input signal is analog, PCM audio, or encoded with Dolby Digital in 2-channel.
- If "CENTER SP" on the SET MENU is set to the NONE position, the sound output level of the center speaker cannot be adjusted. This is because the center channel sound is automatically output from the right and left main speakers.
- Once the sound output level has been adjusted, the level will be the same for all DSP programs.

Speaker	Control range (dB)	Preset value
Center	MIN, -20 to +10	0
Right rear	MIN, -20 to +10	0
Left rear	MIN, -20 to +10	0
Subwoofer	MIN, -20 to 0	0

## Adjusting Method

Adjustments should be performed with the remote control while watching the information on the display.

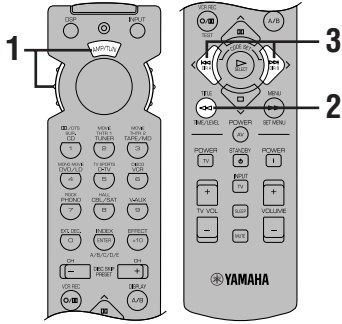

**3** Press > or < to adjust the delay time or speaker output levels.

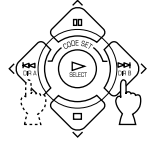

**4** Repeat steps 2 and 3 to adjust the settings of any other item.

### Memory back-up

The memory back-up circuit prevents the stored data from being lost when this unit is set in the standby mode. If, however, the power cord is disconnected from the AC power outlet or the power is cut for more than one week, the latest values for the delay time and the center/rear/subwoofer output levels that were set will automatically return to the preset values. If so, adjust the delay time and output levels again.

**1** Set the selector dial to the AMP/TUN (or DSP/TUN) position.



**2** Press TIME/LEVEL repeatedly to select the item you want to adjust.

Each time you press TIME/LEVEL, the selected item changes and appears on the display as shown below.

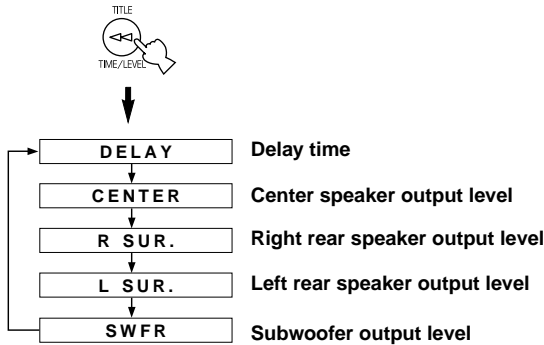

You can also select the item by pressing ∨. (Pressing ∧ changes the selection in the reverse order.)

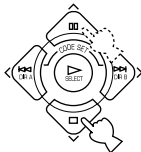

### Note

- Depending on the setting of the SET MENU, you may not be able to select all these items.



# SLEEP TIMER

The SLEEP timer can be used to automatically set this unit in the standby mode. This timer is useful when you are going to sleep while enjoying the desired input source. The SLEEP timer can only be set with the remote control.

### Note

- The SLEEP timer is effective for the components connected to the AC OUTLET(S) on the rear panel of this unit.

## Setting the SLEEP Timer

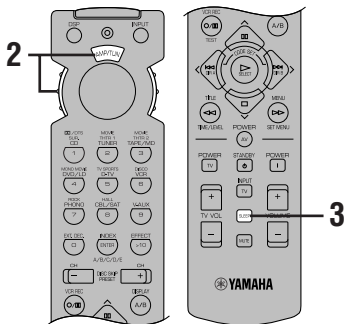

**1** Play a source you want to enjoy when you are going to sleep.

**2** Set the selector dial to a position other than the TV position.



**3** Press SLEEP repeatedly to select the desired SLEEP time.



Each time you press SLEEP, the SLEEP time will change as below:

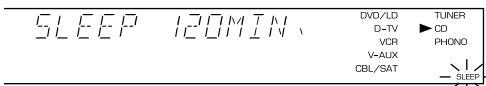
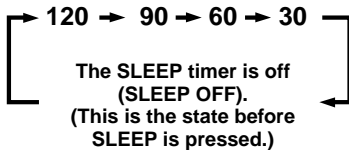

Flashes

**4** The "SLEEP" indicator soon lights up on the display after the SLEEP timer has been set.

The display returns to the previous indication.

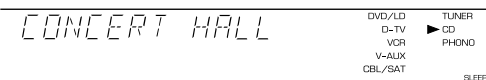

Lights up

## Canceling the Selected SLEEP Timer

Press SLEEP repeatedly until "SLEEP OFF" appears on the display.

It will soon disappear and the "SLEEP" indicator will go off.



→ SLEEP OFF

### Note

- The SLEEP timer can also be canceled by setting the unit in the standby mode by using STANDBY on the remote control (or STANDBY/ON on the front panel), or by disconnecting the AC power cord from the AC power outlet.



# PRESET REMOTE CONTROL

The provided remote control is factory set to control not only this unit but also most YAMAHA audio components connected to it.

## Selector Dial

There are nine positions that you can select to control connected components with this remote control. For example, if the CD position is selected, the remote control is set in the CD operation mode, allowing the CD player to be operated by the buttons on the remote control. When turning the selector dial, the position changes as follows:

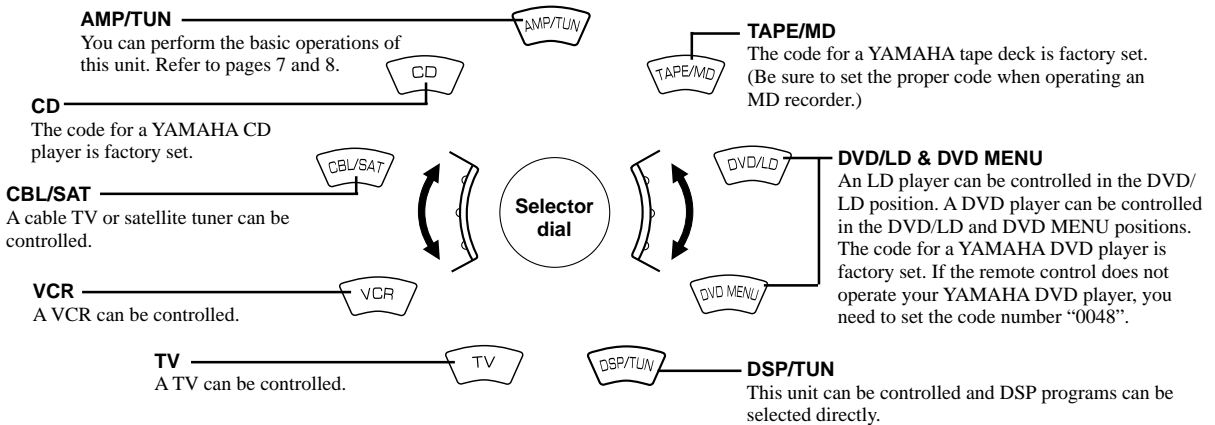

### Note

- The button functions on the remote control differ depending on the position of the selector dial. Refer to the following pages for details.

## Commonly used buttons in any position of the selector dial

Regardless of the position of the selector dial, you can control this unit and your TV with the following buttons.

### Note

- You have to set the code for your TV before you can control the TV.

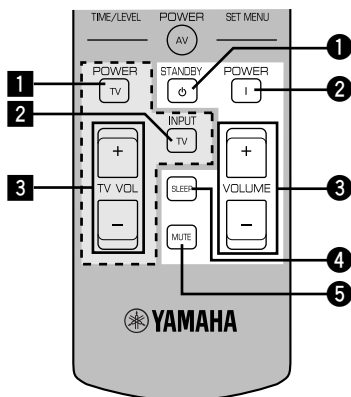

### Controlling this unit

Refer to pages 7 and 8.

- STANDBY
- POWER
- VOLUME (+/-)
- SLEEP

### Note

- If you have set the code for your TV and set the selector dial to the TV position, this button is used to set the SLEEP timer for the TV.

- MUTE

### Note

- If you have set the code for your TV and set the selector dial to the TV position, this button is used to mute the TV sound.

### Controlling your TV

- TV POWER
- TV INPUT
- TV VOLUME

## Controlling the Components Connected to This Unit

### ■ Example: To control a YAMAHA CD player

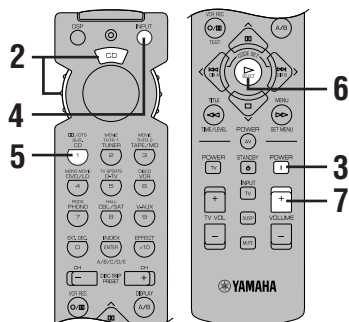

**1** Make sure that **VOLUME** is set to the “∞” position.

**2** Set the selector dial to the **CD** position.



**3** Turn on the power.



**4** Press **INPUT**.

The indicator lights up for about three second.



**5** Press **CD** (number 1) while the indicator is lit.



**6** Press **▶**.

Refer to page 48 for the CD player operation buttons.

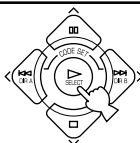

**7** Adjust the volume.

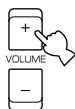

If you set the remote control with the manufacturers' codes **listed from page i at the end of this manual**, you can control other brands of components. Refer to “Setup codes” on page 51 for details.



## Description of Each Position

### ■ TAPE/MD position

Select the TAPE/MD position.

**O/||| REC/PAUSE**  
This button gives a pause in recording on a tape deck or MD recorder.

**▷ PLAY**  
This button plays a tape or an MD.

**◀◀ DIR A (TAPE)**  
This button selects the playing direction of deck A.  
**SKIP- (MD)**  
This button skips to the beginning of the previous track.

**◀◀ REWIND (TAPE)**  
This button rewinds a tape.  
**SEARCH (MD)**  
This button initiates a backward search on the track that is playing to find the point from which you want to listen.

**▶▶ DIR B (TAPE)**  
This button selects the playing direction of deck B.  
**SKIP+ (MD)**  
This button skips to the beginning of the next track.

**□ STOP**  
This button stops operation on a tape deck or MD recorder.

**▶▶ FAST FORWARD (TAPE)**  
This button winds a tape fast forward.  
**SEARCH (MD)**  
This button initiates a fast-forward search on the track that is playing to find the point from which you want to listen.

**AV POWER**  
(TAPE) This button turns on the tape deck that has a remote control with a power button if you have set the code for another manufacturer.  
(MD) This button turns on the MD recorder that has a remote control with a power button if you have set the code for another manufacturer.

**Numeric buttons (MD)**  
**+10 (MD)**  
While the indicator lights up for about three seconds after pressing DSP, this button turns on or off the effect speakers (center and rear).

**DECK A/B (TAPE)**  
This button selects deck A or B on a double-cassette tape deck.  
**DISPLAY (MD)**

**||| PAUSE (MD)**  
This button gives a pause in operation.

- The dark-shaded buttons do not function.
- If your component does not respond to any of the codes listed for the manufacturer, use the original remote control supplied with your component.

## ■ CD position

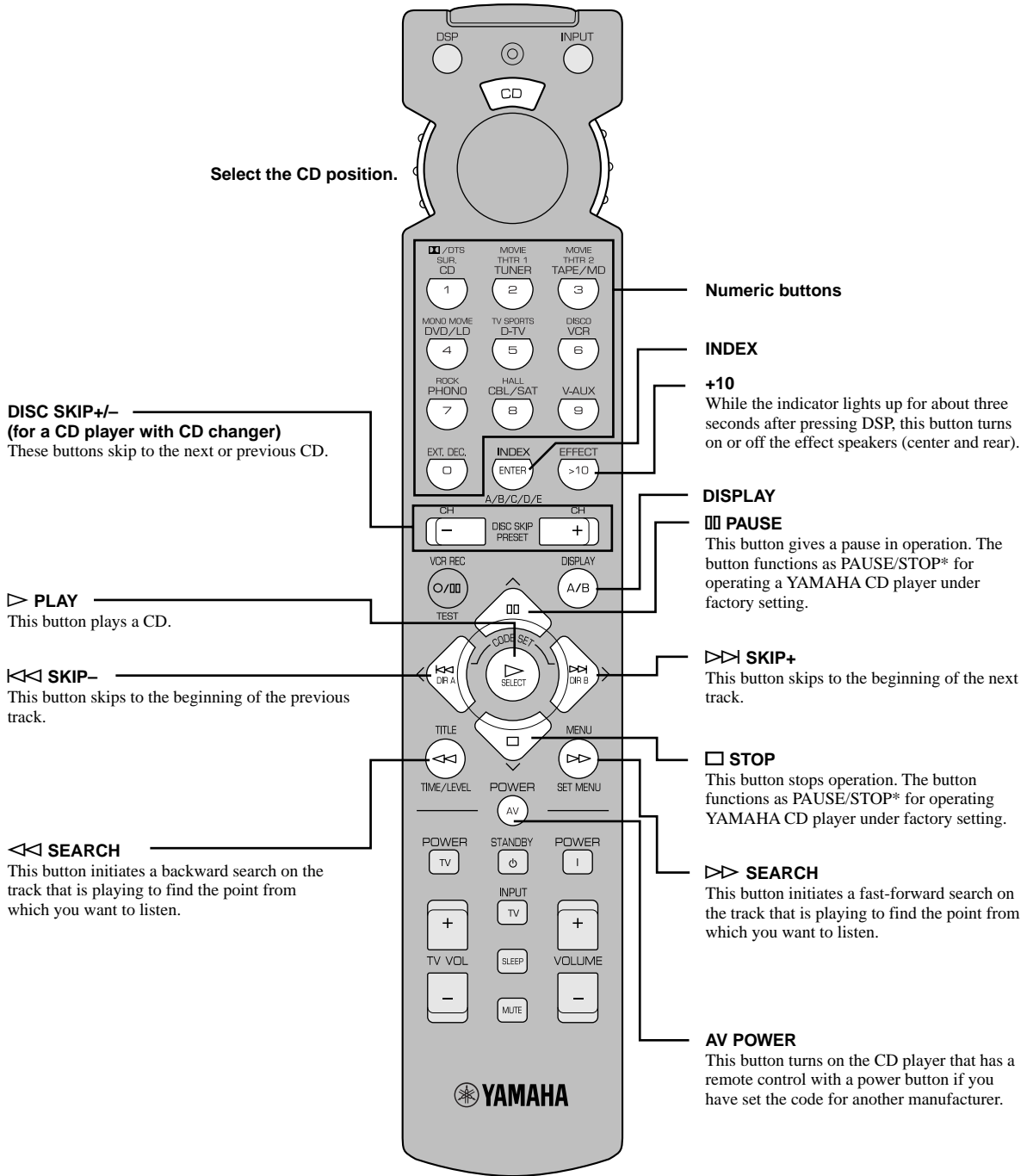

### PAUSE/STOP function

Press the button once to give a pause in operation and press once more to stop operation.

- The dark-shaded buttons do not function.
- If your component does not respond to any of the codes listed for the manufacturer, use the original remote control supplied with your component.

## DVD/LD position

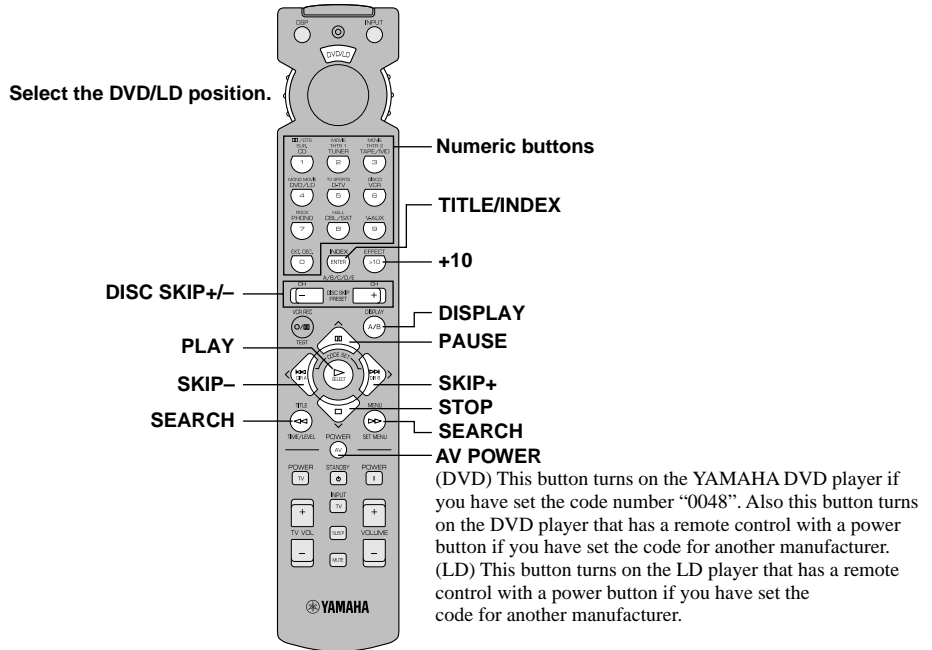

## DVD MENU position

**Note**

- DVD MENU operations cannot be performed for some DVD players.

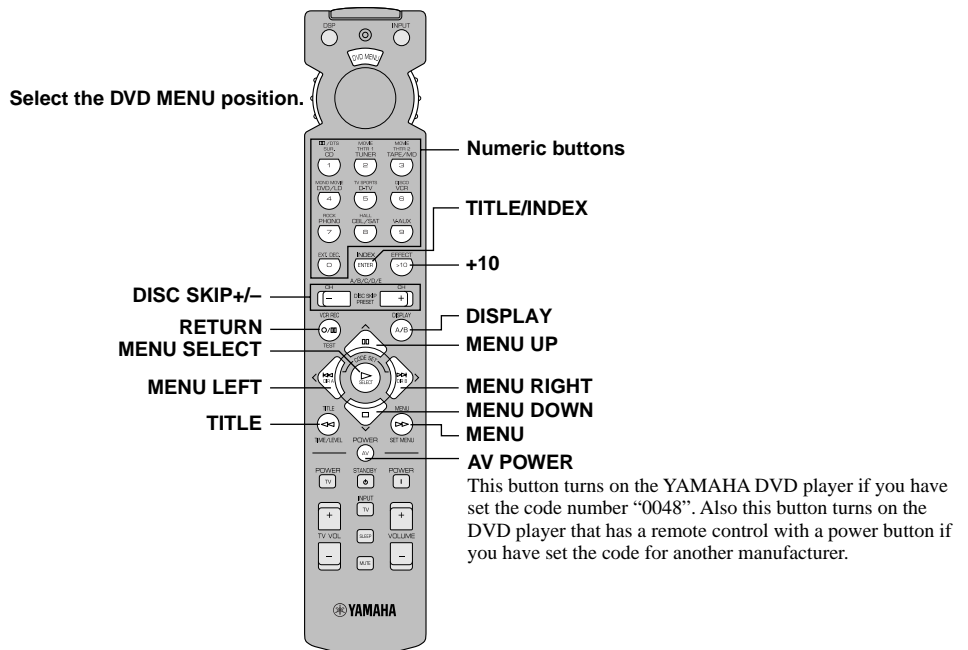

- The dark-shaded buttons do not function.
- If your component does not respond to any of the codes listed for the manufacturer, use the original remote control supplied with your component.

■ VCR position

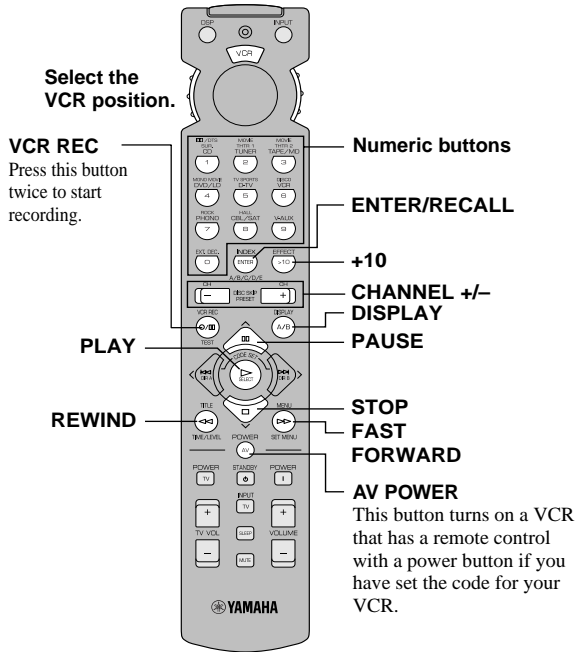

■ CBL/SAT position

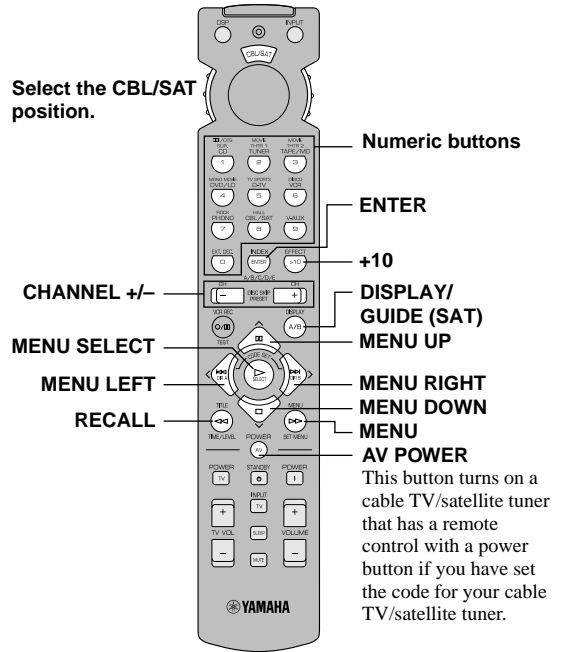

■ TV position

**Note**

- You can control your VCR if you have set the code for it.

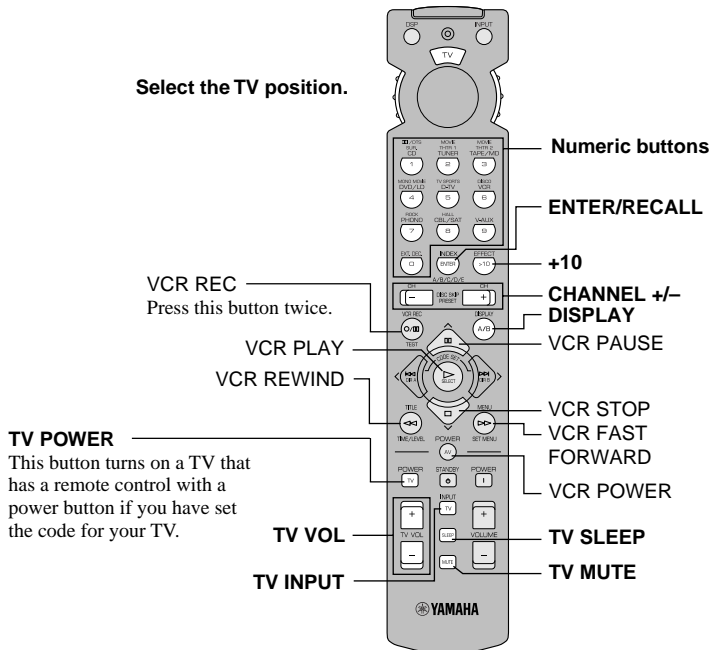

- The dark-shaded buttons do not function.
- If your component does not respond to any of the codes listed for the manufacturer, use the original remote control supplied with your component.

## Advanced Information

### ■ Setup codes

You can set the code for the manufacturer of your component in each position of the selector dial.

#### 1 Turn on your component to be used.

#### 2 Set the selector dial to the desired position for the component (TAPE/MD, CD, DVD/LD, etc.).

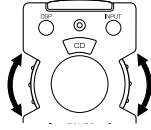

#### 3 Press > (right) and < (left) at the same time for about four seconds.

The indicator flashes twice.

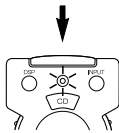
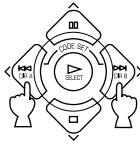

#### 4 Use the numeric buttons to enter the four-digit manufacturer's code for the component to be used. Make sure that the indicator flashes twice.

If the indicator does not flash or flashes rapidly several times, repeat step 3 and re-enter the code.

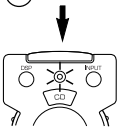
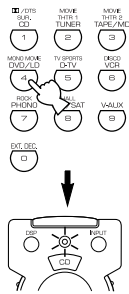

#### 5 Press AV POWER (or any other button) on the remote control to check if you have set the code correctly.

If your component cannot be controlled with the remote control, try setting another code for the same manufacturer.



### Notes

- You can set only one code for one position.
- In the DVD/LD and DVD MENU positions: Be sure to set the selector dial to the DVD/LD position before entering the code for the DVD/LD player. The code set in the DVD/LD position is also simultaneously set in the DVD MENU position. You cannot set the code for a DVD player when the selector dial is set to the DVD MENU position.
- If your component does not respond to any of the codes listed for the manufacturer, use the original remote control supplied with your component.

### ■ To use a second (and third) VCR

You can control a second (and third) VCR in the CBL/SAT and DVD MENU positions if a cable TV or satellite tuner, or DVD player is not being used.

### Note

- If you want to control a second (and third) VCR in the DVD MENU position, you must set the code for an LD player in the DVD/LD position.

#### 1 Turn on the VCR to be used.

#### 2 Set the selector dial to the CBL/SAT or DVD MENU position.

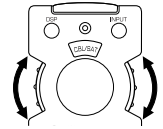

#### 3 Press > (right) and < (left) at the same time for about four seconds.

The indicator flashes twice.

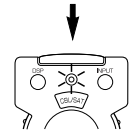
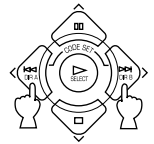

#### 4 Use the numeric buttons to enter the four-digit code for the second (and third) VCR. Make sure that the indicator flashes twice.

If the indicator does not flash or flashes rapidly several times, repeat step 3 and re-enter the code.

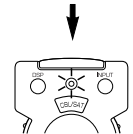
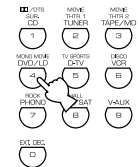

#### 5 Press AV POWER (or any other button) on the remote control to check if you have set the code correctly.

If the VCR cannot be controlled with the remote control, try setting another code for the same manufacturer.



## ■ Returning to the factory-set codes

To return to the factory-set codes in all positions, follow these steps.

- 1 Press > (right) and < (left) at the same time for about four seconds.**

The indicator flashes twice.

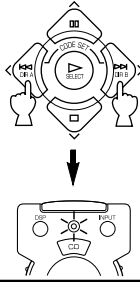

- 2 Enter the code number "9990".**

Make sure that the indicator flashes twice.

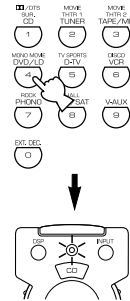

To return to the factory-set codes in each position, follow these steps.

- 1 Set the selector dial to the position for the component to be returned to the factory-set code.**

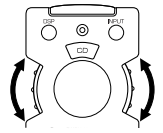

- 2 Press > (right) and < (left) at the same time for about four seconds.**

The indicator flashes twice.

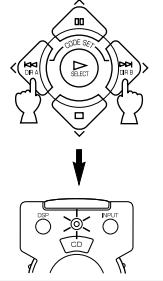

- 3 Enter the code number "0000".**

Make sure that the indicator flashes twice.

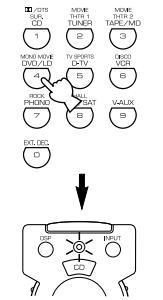

The following codes are factory set.

Selector dial position	Component	Code
TV	TV	0101
CBL/SAT	Satellite tuner	0006
VCR	VCR	0002
DVD/LD	DVD player	0008 (YAMAHA DVD player)
CD	CD player	0005 (YAMAHA CD player)
TAPE/MD	Tape deck	0004 (YAMAHA Tape deck)
AMP/TUN	this unit	0003
DSP/TUN	this unit	0013

We recommend that you write all the code numbers you have set on the "Quick Reference Card".



# TROUBLESHOOTING

If the unit fails to operate normally, check the following points to determine whether the fault can be corrected by the simple measures suggested. If it cannot be corrected, or if the fault is not listed in the SYMPTOM column, disconnect the power cord and contact your authorized YAMAHA dealer or service center.

## ■ General

SYMPTOM	CAUSE	REMEDY	Refer to page
The unit fails to turn on when STANDBY/ON (or POWER) is pressed, or enters in the standby mode soon after the power has been turned on.	The power cord is not connected or the plug is not completely inserted.	Firmly connect the power cord.	18
	The IMPEDANCE SELECTOR switch on the rear panel is not fully set to the right or left position.	Set the switch fully to the right or left position when the unit is in the standby mode.	18
The unit does not work normally.	The internal microcomputer has been frozen by an external electric shock (lightning, excessive static electricity, etc.) or by a power supply with low voltage.	Set the unit in the standby mode and disconnect the AC power cord from the AC power outlet. After about 30 seconds have passed, connect the power and operate the unit again.	—
No sound and/or no picture.	Incorrect input or output cable connections.	Connect the cables properly. If the problem persists, the cables may be defective.	13, 14
	An appropriate input source has not been selected.	Select an appropriate input source with INPUT SELECTOR or TAPE/MD MON / EXT. DECODER (or the input selector buttons).	21
	The speaker connections are not secure.	Secure the connections.	16
	SPEAKERS have not been set properly.	Set SPEAKERS corresponding to the speakers in use to the ON position.	21
	The sound is muted.	Set VOLUME to the "∞" position, press MUTE to cancel a mute and adjust the volume.	22
	Digital signals other than PCM audio and the signals encoded with Dolby Digital or DTS which this unit cannot reproduce are being input to this unit by a CD-ROM, etc.	Play a source whose signals this unit can reproduce.	—
No picture.	There is no S VIDEO connection between this unit and the TV monitor, although S video signals are being input to this unit.	Connect the monitor's "S" video input terminal to this unit's S VIDEO MONITOR OUT terminal.	14
The sound suddenly goes off.	The protection circuit has been activated because of a short circuit, etc.	Set the unit in the standby mode and then turn on to reset the protection circuit.	—
	The SLEEP timer has functioned.	Turn on the power, and play the source again.	44
Only the speaker on one side can be heard.	Incorrect cable connections.	Connect the cables properly. If the problem persists, the cables may be defective.	16
	Incorrect setting of BALANCE.	Adjust it to the appropriate position.	22
No sound from the effect speakers.	The sound effect is off.	Press EFFECT to turn it on.	26
	A Dolby Surround, Dolby Digital or DTS decoding DSP program is being used with material not encoded with Dolby Surround, Dolby Digital or DTS.	Select another DSP program.	37
	The 96-kHz sampling 24-bit digital signals are input to this unit.		24

<b>SYMPTOM</b>	<b>CAUSE</b>	<b>REMEDY</b>	<b>Refer to page</b>
<b>No sound from the center speaker.</b>	The sound output level of the center speaker is set to minimum.	Raise the level of the center speaker.	42
	“CENTER SP” on the SET MENU is set to the NONE position.	Select the LRG or SML position.	39
	Incorrect DSP program is selected.	Select the appropriate program.	35, 36, 37
	The source encoded with Dolby Digital or DTS does not have a center channel signal.		—
<b>No sound from the rear speakers.</b>	The output level of the rear speakers is set to minimum.	Raise the output level of the rear speakers.	42
	A monaural source is being played with the PRO LOGIC/Normal or PRO LOGIC/ENHANCED program.	Select another DSP program suitable for the monaural source.	37
<b>No sound from the subwoofer.</b>	“BASS OUT” on the SET MENU is set to the SW or MAIN position when playing a 2-channel source.	Select the BOTH position.	39
	The source does not contain low bass signals (below 90 Hz).		—
<b>A “humming” sound can be heard.</b>	Incorrect cable connections.	Firmly connect the audio plugs. If the problem persists, the cables may be defective.	13, 14
	No connection from the turntable to the GND terminal.	Make the GND connection between the turntable and this unit.	13
<b>The volume level is low while playing a record.</b>	The record is being played on a turntable with an MC cartridge.	The turntable should be connected to the unit through the MC head amplifier.	13
<b>The volume level cannot be increased, or the sound is distorted.</b>	The component connected to the TAPE/MD OUT (REC) terminals of this unit is in the standby mode.	Turn on the power to the component.	—
<b>The sound effect cannot be recorded.</b>	It is not possible to record the sound effect by a tape deck or MD recorder connected to the TAPE/MD OUT (REC) terminals of this unit.		34
<b>The DVD/LD, TV/digital TV or cable TV/satellite tuner source cannot be recorded by a tape deck, MD recorder or VCR connected to this unit.</b>	The DVD/LD player, TV/digital TV or cable TV/satellite tuner is connected to the unit only through the digital terminals.	Make additional connections between the analog terminals.	14
<b>Adjusting this unit by using SET MENU, TIME/LEVEL or TEST cannot be performed.</b>	“MEM. GUARD” on the SET MENU is set to the ON position.	Set “MEM. GUARD” to the OFF position.	41



## ■ Tuner

	SYMPTOM	CAUSE	REMEDY	Refer to page
FM	FM stereo reception is noisy.	The characteristics of FM stereo broadcasts may cause this problem when the transmitter is too far away or the antenna input is poor.	Check the antenna connections. Try using a high-quality directional FM antenna. Use the manual tuning method.	11, 27
	There is distortion, and clear reception cannot be obtained even with a good FM antenna.	There is multipath interference.	Adjust the antenna position to eliminate multipath interference.	11
	The desired station cannot be tuned in with the automatic tuning method.	The station is too weak.	Use the manual tuning method. Use a high-quality directional FM antenna.	11, 27
	Previously preset stations can no longer be tuned in.	The unit has been disconnected for a long period.	Re-store the stations.	28
AM	The desired station cannot be tuned in with the automatic tuning method.	The signal is weak or the antenna connections are loose.	Tighten the AM loop antenna connections and orient it for best reception. Use the manual tuning method.	12, 27
	There are continuous crackling and hissing noises.	Noises result from lightning, fluorescent lamps, motors, thermostats and other electrical equipment.	Use an outdoor antenna and a ground wire. This will help somewhat, but it is difficult to eliminate all noise.	12
	There are buzzing and whining noises (especially in the evening).	A TV set is being used nearby.	Move this unit away from the TV.	—

## ■ Remote control

	SYMPTOM	CAUSE	REMEDY	Refer to page
	The remote control does not work.	Direct sunlight or lighting (from an inverter type of fluorescent lamp, etc.) is striking the remote control sensor of this unit.	Reposition the unit.	3
		The batteries are weak.	Replace all batteries with new ones.	2
	The unit or other component cannot be controlled.	The component to be controlled has not been selected.	Set the selector dial to the appropriate position, corresponding to the component to be controlled.	45
		The remote control cannot control system components.		—
		The manufacturer's code has not been set properly.	Enter the code again.	51
			Try setting another code for the same manufacturer.	
Depending on the manufacturer or the model, some components cannot be controlled with this unit's remote control even though the code has been set properly.	Use the original remote control supplied with your component.	—		

## ■ Others

	SYMPTOM	CAUSE	REMEDY	Refer to page
	The sound is degraded when listening with headphones to a tape deck or CD player connected to this unit.	This unit is in the standby mode.	Turn on the power of the unit.	—
	There is noise interference from digital or high-frequency equipment, or the unit.	The unit is too close to the digital or high-frequency equipment.	Move the unit further away from such equipment.	—

## ■ When playing back a source encoded with DTS

SYMPTOM	CAUSE	REMEDY	Refer to page
A loud hissing noise is heard when playing back a source encoded with DTS.	The player which plays back the source is not connected to a digital audio signal input terminal of this unit.	The player must be connected to a digital audio signal input terminal of this unit besides the analog audio signal terminal connections.	14
	The input mode is set to ANALOG on this unit.	Set a proper input mode to turn on the built-in DTS decoder.	23
A percussive noise is heard when playing back a source encoded with DTS.	If the input mode is set to AUTO, depending on some sources, there may be a noise heard while this unit is identifying the format of the input signal.	Set the input mode of the currently selected input source to DTS.	23
No sound is heard when playing back a source encoded with DTS, even if the input mode is set to AUTO on this unit.	The built-in DTS decoder does not function because the player has a digital volume control and it is set at a position other than "maximum," "neutral" or "ineffective."	Set the player's digital volume control at the maximum, neutral or ineffective position.	—
No sound is heard when playing back an MD or DAT on which has been recorded a source encoded with DTS.	A source encoded with DTS cannot be recorded on an MD or DAT.		—
No sound is heard when playing back a source (CD, etc.) even if the currently selected input mode is AUTO.	In the AUTO mode, the DTS-decoding mode cannot be automatically changed to the normal (PCM) digital signal input mode.	Set the input mode to AUTO again.	24

### Notes

- It is necessary to use a DTS decoder to play back a source encoded with DTS, so the player which plays back the source must be connected to a digital audio input terminal of this unit in the way described in this manual. If this connection is not made or only a D-to-A converter is being used without using a DTS decoder, only a loud hissing noise will be heard when you play back the source.
- The "dts" indicator will flash when the input mode is set to AUTO and a search or skip operation is performed while playing back a source encoded with DTS. If this status continues for 30 or more seconds, the unit will automatically switch from DTS-decoding mode to PCM digital signal input mode and the "dts" indicator will go out.



# SPECIFICATIONS

## AUDIO SECTION

- Minimum RMS Output Power  
20 Hz to 20 kHz, 0.06% THD, 8 ohms  
Main L/R, Center, Rear L/R ..... 100 W\*/70 W  
1 kHz, 0.09% THD, 8 ohms  
Main L/R, Center, Rear L/R ..... 110 W\*/80 W
- Maximum Output Power (EIAJ)  
1 kHz, 10% THD, 8 ohms ..... 105 W
- DIN Standard Output Power  
1 kHz, 0.7% THD, 4 ohms ..... 110 W
- IEC Output Power  
1 kHz, 0.06% THD, 8 ohms ..... 75 W
- Dynamic Power (IHF)  
8/6/4/2 ohms ..... 130/150/190/240 W\*, 90/110/135/160 W
- Damping Factor  
20 Hz to 20 kHz, 8 ohms ..... 80
- Frequency Response  
CD etc. to MAIN L/R ..... 10 Hz to 100 kHz, -3 dB
- Total Harmonic Distortion (20 Hz to 20 kHz)  
CD etc. to MAIN L/R, 1/2 power, 8 ohms ..... 0.06%
- Signal-to-Noise Ratio (IHF-A Network)  
CD etc. to MAIN L/R  
(150 mV, Input Shorted) ..... 99 dB  
(250 mV, Input Shorted) ..... 103 dB
- Residual Noise (IHF-A Network)  
MAIN L/R ..... 150  $\mu$ V
- Input Sensitivity/Impedance  
CD etc. .... 150 mV/47 k-ohms  
EXT. DECODER ..... 150 mV/40 - 47 k-ohms
- Output Level/Impedance  
REC OUT ..... 150 mV/1.2 k-ohms  
PRE OUT ..... 2.1 V/1.2 k-ohms  
SUBWOOFER ..... 4.0 V/1.2 k-ohms  
PHONES ..... 0.34 V/560 ohms
- Channel Separation (Vol. -30 dB)  
CD etc. (Input 5.1 k-ohms Terminated, 1 kHz/10 kHz)  
..... 60 dB/45 dB
- Tone Control Characteristics  
BASS: Boost/cut .....  $\pm$ 10 dB/50 Hz  
TREBLE: Boost/cut .....  $\pm$ 10 dB/20 kHz

\* for U.S.A. and Canada models

## VIDEO SECTION

- Video Signal Type ..... NTSC or PAL
- Video Signal Level ..... 1 Vp-p/75 ohms
- Signal-to-Noise Ratio ..... 50 dB
- Monitor Out Frequency Response ..... 5 Hz to 10 MHz, -3 dB

## FM SECTION

- Tuning Range ..... 87.5/87.50 to 107.9/108.00 MHz
- Usable Sensitivity (DIN)  
Mono (S/N 26 dB) ..... 0.9  $\mu$ V  
Stereo (S/N 46 dB) ..... 28  $\mu$ V
- Selectivity (two signals, 40 kHz Dev.,  $\pm$ 300 kHz) ..... 55 dB
- Signal-to-Noise Ratio (Mono/Stereo)  
DIN ..... 75 dB/69 dB  
IHF ..... 81 dB/75 dB
- Harmonic Distortion (1 kHz)  
Mono/Stereo ..... 0.1/0.2%
- Stereo Separation (1 kHz) ..... 48 dB
- Frequency Response ..... 20 Hz to 15 kHz,  $\pm$ 1 dB
- Antenna Input ..... 75 ohms, Unbalanced

## AM SECTION

- Tuning Range ..... 530/531 to 1,710/1,611 kHz
- Usable Sensitivity ..... 300  $\mu$ V/m
- Signal-to-Noise Ratio ..... 52 dB
- Antenna ..... Loop antenna

## GENERAL

- Power Supply  
[U.S.A. and Canada models] ..... AC 120 V, 60 Hz  
[Europe, U.K. and Singapore models] ..... AC 230 V, 50 Hz  
[Australia model] ..... AC 240 V, 50 Hz  
[China model] ..... AC 220 V, 50 Hz  
[General model] ..... AC 110/120/220/240 V, 50/60 Hz
- Power Consumption ..... approx. 310 W
- Power Consumption (standby mode) ..... approx. 1 W
- AC Outlets (100 W max. total)  
[U.K. and Australia models] ..... 1 (SWITCHED)  
[Other models] ..... 2 (SWITCHED)
- Dimensions (W x H x D)  
..... 435 x 151 x 391 mm (17-1/8" x 5-15/16" x 15-3/8")
- Weight ..... 11.2 kg (25 lbs.)
- Accessories ..... AM loop antenna  
..... Indoor FM antenna  
..... 75-ohm/300-ohm antenna adapter (U.K. model only)  
..... Antenna adapter (U.S.A. and Canada models only)  
..... Remote control  
..... Batteries

Specifications are subject to change without notice.



## GLOSSARY

### ■ Dolby Surround

Dolby Surround uses four discrete channels and five speakers to reproduce realistic and dynamic sound effects: two main channels (left and right), a center channel for dialog, and a rear channel for special sound effects. The rear channel reproduces sound within a narrow frequency range. Most video tapes and laser discs include Dolby Surround encoding, as do many TV and cable broadcasts. The Dolby Pro Logic decoder built into this unit employs a digital signal processing system that stabilizes each channel for even more accurate sound positioning than is available with standard analog processors.

### ■ Dolby Digital

Dolby Digital is a digital surround sound system that provides completely independent multi-channel audio to you. Dolby Digital provides five full-range channels in what is sometimes referred to as a “3/2” configuration: three front channels (left, center and right), and two surround channels. A sixth bass-only effect channel is also provided for output of LFE (low frequency effect), or low bass effects that are independent of other channels. (This is called the “LFE channel”.) This channel is counted as 0.1, thus giving rise to the term 5.1 channels in total.

The wide dynamic range of sound reproduced by the five full-range channels and precise sound orientation by digital sound processing provides listeners with excitement and realism that have never been experienced before.

### ■ DTS (Digital Theater System) Digital Surround

DTS was developed to replace the analog soundtracks of movies with six discrete channels of digital soundtracks, and it is now installed in many theaters around the world. The DTS digital playback system changed the way we experienced movies in theaters with six discrete channels of superb digital audio.

DTS technology, through intense research and development has made it possible to deliver similar encode/decode discrete technology to home audio surround-sound entertainment.

DTS Digital Surround is an encode/decode system which delivers six channels of master-quality, 20-bit audio; technically, it is 5.1 channels, which means 5 full-range (left, center, right and two surround) channels, plus a subwoofer (LFE) channel (as “0.1”). It is compatible with the 5.1 speaker configurations that are currently available for home theater systems.

### ■ CINEMA DSP CINEMA DSP

The Dolby Surround and Dolby Digital sound and DTS systems show their full ability in a large movie theater, because movie sounds are originally designed to be reproduced in a large movie theater that uses a multitude of speakers. Trying to create a sound environment similar to that of a movie theater in your home is difficult because of the room size, material inside the walls, the number of speakers, and so on. In other words, your listening room is very different from a movie theater.

However, YAMAHA DSP technology allows you to create nearly the same sound experience as that of a large movie theater in your home by compensating for the lack of presence and dynamics in the listening room with original digital sound fields combined with Dolby Surround, Dolby Digital or DTS Digital Surround sounds.

The YAMAHA “CINEMA DSP” logo indicates those programs that are created by the combination of YAMAHA DSP technology and Dolby Surround, Dolby Digital or DTS.

### ■ LFE 0.1 Channel

This channel is for reproduction of low bass signals. The frequency range for this channel is 20 Hz to 120 Hz. This channel is called the channel 0.1 because it only reproduces a low frequency range compared to the full-range from 20 Hz to 20 kHz that is reproduced by the 5 channels in a Dolby Digital or DTS 5.1 channel system.

### ■ S VIDEO Signal

The S VIDEO signal is separated and transmitted as the Y signal which indicates the luminance and the C signal which indicates the chroma of the video signal (composite signal). Using the S VIDEO terminal eliminates video signal transmission loss and allows recording and playback of even more beautiful images.



# INDEX

<b>A</b>	
Accessories .....	2
AC outlet .....	18
Antennas .....	11, 12
<b>B</b>	
BALANCE .....	22
BGV (background video) function .....	22
<b>C</b>	
Canceling sound effect .....	26
CINEMA DSP .....	37, 58
Connections	
Antennas .....	11, 12
Audio components (tape deck/MD recorder, CD player and turntable) .....	13
Digital connections .....	14
Speakers .....	16
TV monitor .....	14
Video components (DVD/LD player, VCR, TV/digital TV and cable TV/satellite tuner) .....	14
<b>D</b>	
Delay time (TIME/LEVEL mode) .....	42
Display .....	6
Dolby Digital .....	58
Dolby Surround .....	58
DSP program .....	25, 35 to 37
DTS Digital Surround .....	58
<b>E</b>	
External decoder .....	15
<b>F</b>	
Front panel .....	4
<b>I</b>	
IMPEDANCE SELECTOR switch .....	18
Input mode .....	23
<b>L</b>	
LFE .....	40, 41, 58
<b>M</b>	
Muting .....	22
<b>P</b>	
Playing .....	21
Preset stations	
To recall a preset station .....	29
Exchanging preset stations .....	30
Preset tuning	
Automatic preset tuning .....	28
Manual preset tuning .....	29
<b>R</b>	
RDS mode	
EON function .....	33
PTY SEEK function .....	32
Recording .....	34
Remote control	
Basic operations .....	7, 8
Batteries .....	2
Factory-set code .....	52
Manufacturer's codes ..... i (at the end of this manual)	
Selector dial .....	7, 45
Setup codes .....	51
<b>S</b>	
SET MENU .....	38
Sleep timer .....	44
Speaker	
Output levels (TIME/LEVEL mode) .....	42
Output mode (SET MENU) .....	39, 40
Speaker balance (test tone) .....	19
Placement .....	9
STANDBY/ON .....	4
<b>T</b>	
Test tone .....	19, 20
Tone controls .....	22
Tuning	
Automatic tuning .....	27
Manual tuning .....	27

**LIST OF MANUFACTURER'S CODES  
LISTES DES CODES FABRICANT  
VERZEICHNIS DER HERSTELLERCODES  
LISTA ÖVER TILLVERKARKODER  
ELENCO DEI CODICI DEL FABBRICANTE  
LISTA DE CÓDIGOS DE FABRICANTES  
LIJST VAN CODES VAN FABRIKANT**

<b>TV</b>		CLARIVOX	0821, 0961, 1971	FIRST LINE	1981	HITACHI	0001, 0011, 0031, 0081, 0141, 0291, 0331, 0341, 0451, 0601, 0631, 0701, 1281, 1561, 1601, 1821, 1831, 1841, 1861, 1871, 1881, 1891, 1941, 1981, 2051, 2321, 2341
ADMIRAL	0411, 0451, 0911, 1021, 1081	CLATRONIC	1181, 1331	FISHER	0021, 0091, 0141, 0511, 0601, 0801, 0821, 0981, 1021, 1081, 1981, 2091		
AIKO	0891	CONCERTO	0791				
AKAI	0061, 0101, 0231, 1191, 1351, 1591, 1641, 1791, 1891, 1981	CONDOR	0761	FORGESTONE	2281		
		CONTEC	0151, 1171	FORMENTI	0451, 0491, 0761, 1081, 1451, 1541, 1981		
		CONTINENTAL EDISON	0571, 0651, 0901	FORMENTI-PHOENIX	0021, 0431, 0451, 0591, 1411	HYPER	0591, 0601, 1511, 1621
AKURA	1331	CRAIG	1171			IMPERIAL	0451, 0491, 0811, 0981, 1401, 1611, 1621, 2201, 2251, 2271
ALBA	1241, 1331, 2361	CROSLEY	0021, 0491, 1021, 2201, 2251, 2271	FORTRESS	1081		
ALBIRAL	1971	CROWN	2541	FRONTECH	0451, 1181, 1981		
AMSTRAD	1301, 1511	CTC CLATRONIC	0261	FUJITSU	1261		
ANAM	1171	CXC	1171	FUNAI	0391, 0691, 1171, 1181, 1261	INGERSOL	1511
ARC EN CIEL	0571	DAEWOO	0101, 1501, 1511, 2611			INNO HIT	0581, 0601, 0841, 1101, 1331, 1371, 1511, 2011
ARCAM	0571, 0761	DANSAI	0101	FUTURETECH	1171		
ARISTONA	0751	DECCA	0271, 0581, 0601, 0971, 1101, 1691	GBC	0021, 0141, 1321, 1511, 1621, 1981	INNOVATION	2591, 2601, 2611, 2621, 2641, 2651, 2661, 2711, 2721, 2761, 2771, 2781
ARTHUR MARTIN	0451, 1641	DECCA (UK)	0271, 0581, 0601, 1101, 1681	GEC	0451, 1101, 1281, 2321		
ASA	0411, 0451, 0521, 0781, 0871, 1021, 1081, 1421, 2051, 2091, 2151, 2551	DEGRAAF	0451, 1351	GEC (UK)	0031, 0081, 0581, 0601, 1101, 1281, 1561	INTERFUNK	0031, 0041, 0061, 0121, 0181, 0451, 0491, 1081, 1641, 1791, 1821, 1981, 2231
ASTRA	1511	DIXI	0991, 1511	GELOSO	0021, 0411, 0451, 1321, 1511, 1621, 1981		
ATANTIC	0761	DOMEOS	0101	GENERAL TECHNIC	2681	IRRADIO	0491, 1321, 1331, 1371, 1411, 1511, 2011
ATLANTIC	0761	DORIC	1031	GENEXXA	0451, 1331		
ATORI	1511	DUAL	0091, 0601, 1611, 1641, 2101	GOLDSTAR	0591, 0601, 0761, 0791, 1371, 1491, 1511, 1561, 1621, 1641	ISUKAI	1331
AUDIOSONIC	1181, 1321, 1511	DUAL-TEC	0601, 1511, 1621, 2111			ITT	0031, 0041, 0051, 0061, 0071, 0081, 0181, 0411, 0451, 0491, 1241, 1291, 1351, 1501, 1601, 1641, 1741, 1921, 1981, 2091, 2331, 2431
AUSIND	0491, 1411	DUMONT	0261, 0521, 0781, 1021, 1081, 1981, 2121, 2151	GOODMANS	0141, 1101, 1371, 1641, 2301		
AUTOVOX	0091, 0351, 0481, 0491, 0601, 0781, 0951, 1051, 1081, 1391, 1421	DYNATRON	0101	GÖRENJE	0981, 1061		
		ELBE	1551, 1971, 2031	GRAETZ	0451		
BAIRD	1101, 1351	ELECTRO TECH	1511	GRANADA	0141, 0451, 0491, 0581, 0601, 1101, 1111, 1351, 1981, 2321	ITT-NOKIA	0031, 0041, 0051, 0061, 0071, 0081, 0181, 0411, 0451, 0491, 1241, 1291, 1351, 1501, 1601, 1641, 1741, 1921, 1981, 2091, 2331, 2431
BANG & OLUFSEN	1081	ELEKTRONSKA	0771				
BASIC LINE	1321, 1331	ELMAN	0261, 1621	GRUNDIG	0221, 0231, 0471, 0491, 0711, 0741, 1381, 2021, 2041, 2141, 2151	JVC	0071, 0721, 1441, 1581, 1591, 1741, 1791
BAUER	1451	ELTA	1511	HANSEATIC	0021, 0121, 0141, 0431, 0591, 1561		
BAUR	0041, 0061, 0121, 0131, 0221, 1561	EMERSON	0921, 1021, 1081, 1121, 1171, 1261, 1301	HANTAREX	0581	KAISUI	0591, 1321, 1331
BEKO	2491, 2501	ERRES	0101	HEMMERMANN	0061	KAMOSONIC	0601
BLAUPUNKT	0221, 0231, 0241, 0251, 0471, 0741, 2201, 2211, 2221, 2231, 2241, 2261, 2571, 2581	ETRON	1981	HIFIVOX	0331, 0571	KARCHER	0591, 0601, 0841, 1091, 1321, 1511, 1561, 2051
		EUROPHON	0261, 0581, 0601, 0771, 1091, 1621, 2001	HINARI	0071, 0141, 0451, 1261, 1351, 1511, 1641, 1981, 2011		
BRANDT	0571, 0651, 0731, 0901, 1821	FENNER	0101, 1511			KAWASHO	0761
BRIONVEGA	1021, 1051, 1081	FERGUSON	0281, 0371, 0551, 0651, 0781, 0861, 0881, 1131, 1181, 1361, 1461, 1971, 1991, 2281, 2311, 2341			KENDO	0261
BRITANNIA	0761	FIDELITY	0451, 0761, 2281			KENNEDY	0021, 0351, 0951, 1981
BRUNS	0821, 0991, 1021, 1081	FIDELITY (UK)	0561, 0591, 1931, 2281			KONKA	2701
BSR	0391, 0691, 1621, 1901, 1981	FILMNET	1141			KORTING	0431, 1011, 1021, 1081, 1541
BUSH	0451, 1241, 1331, 1641, 1741, 2131, 2151	FINLANDIA	0451, 2321				
		FINLUX	0021, 0261, 0491, 0521, 0781, 0811, 0871, 1081, 1411, 1421, 1981, 2051, 2091, 2121, 2151, 2551				
BUSH (UK)	0481, 1561, 1611						
CANDLE	0791						
CENTURY	1021, 1081						
CGE	0491, 0811, 0981, 1401, 1531, 1611, 1621, 1981, 2201, 2251, 2271						
CITIZEN	0791						

KTV	0601, 1171	NECKERMANN	0451, 0601,	PRIMA	0451	SELECO	0071, 0101, 0351,
LENOIR	0601, 1511		0981, 1081,	PROFEX	1981		0411, 0451, 0951,
LEYEO	1181		1561, 1931,	PROTECH	0641, 1181, 1981		1901, 2061, 2101,
LIFETEC	2591, 2601, 2611,		1981, 2211,	QUELLE	0041, 0061, 0121,		2111
	2621, 2641, 2651,		2231, 2241		0221, 0231, 0391,	SENTRA	1601
	2661, 2671, 2681,	NEDIATOR	0101		0491, 0521, 0601,	SHARP	0141, 0151, 0191,
	2691, 2711, 2761,	NICAMAGIC	0761		0781, 1371, 1381,		1761, 1781
	2771, 2781	NIKKAI	1101, 1331, 1641,		1411, 1421, 1641,	SIAREM	0021, 0261, 0581,
LOEWE OPTA	0121, 0131, 0581,		1701, 2011		1681, 2051, 2091,		0641, 1021, 1081,
	0611, 1081	NOBLIKO	0261, 0491, 0591,		2141, 2151, 2201,		1981
LOGIC	1691, 2281		0641, 1381, 1411		2211, 2231, 2241,	SICATEL	1971
LOGIK	0551, 1681, 2281	NOGAMATIC	0571		2251, 2271, 2551,	SIEMENS	0151, 0221, 0231,
LOWEWE	0831	NOKIA	0031, 0041, 0051,		2571, 2581		0451, 0741, 2011,
LUMA	0351, 0451, 1901		0061, 0071, 0081,	REDIOMARELLI	0101, 0451,		2201, 2211, 2221,
LUXMAN	0791		0181, 0411, 0451,		0661, 0771,		2231, 2241, 2261,
LUXMAN STEREO TUNER			0491, 1241, 1291,		1081		2571, 2581
	0791		1351, 1501, 1601,	RADIONETTE	0031, 2051, 2091	SILVER	1181
LUXOR	0001, 0061, 0181,		1641, 1741, 1921,	RADIOLA	2291	SINGER	0021, 0261, 1021,
	0341, 0421, 0451,		1981, 2091, 2331,	RANK	0481, 2151		1081
	0461, 0491, 0601,		2431, 2461, 2791	RBM	2131, 2151	SINUDYNE	0021, 0061, 0101,
	0671, 1351, 1371,	NORDMENDE	0031, 0291, 0331,	RBM (UK)	0481		0261, 0391, 0641,
	1561, 1601, 1911,		0451, 0531, 0541,	REDIFFUSION	0451, 0661, 1641,		0691, 0851, 0941,
	1921, 1981		0571, 1051, 1131,		1981, 2331		1021, 1081, 1241,
LYCO	1181		1591, 1791, 1811,	REDIFFUSION (UK)	0061, 0081,		1301, 1321, 1481,
MAGNADYNE	0021, 0061, 0261,		1821, 1891, 1941,		1031		1631, 1981
	0581, 0641, 0771,		2631	REX	0071, 0101, 0351,	SKANTIC	0451
	1021, 1081, 1621,	OCEANIC	0321, 1651, 1981		0411, 0451, 0951,	SOLAVOX	0451, 1641, 2011
	1981	OCEANIC (F)	0031, 0061, 0321,		1901, 2061, 2101,	SONOKO	0101, 1181, 1511
MAGNAFON	0261, 0491, 0581,		0441, 1661		2111	SONY	0141, 0171, 1121,
	0591, 0641, 0761,	ONCEAS	0601	RFT	0991, 2511		1681, 1691, 2751
	1091, 2001	ONWA	1171	ROADSTAR	1321, 1511	SOUNDESIGN	1171
MANESTH	0101	ORION	0061, 0391, 0691,	ROTEL	0151	SSS	1171
MARANTZ	0101		0851, 1211, 1241,	SABA	0291, 0331, 0421,	STERN	0071, 0101, 0351,
MARELLI	1081		1251, 1301, 1481,		0451, 0531, 0541,		0411, 0451, 0951,
MARK	0101		1511, 1681, 1691,		0571, 0581, 0651,		1901, 2061, 2101,
MATSUI	0061, 0451, 0601,		1981, 2371, 2421		0731, 0931, 1021,		2111
	0691, 1101, 1151,	OSAKA	2011		1071, 1081, 1131,	SUNKAI	0691
	1241, 1271, 1301,	OSAKI	1101, 1331, 2011		1791, 1811, 1821,	SUPRA	0791
	1511, 1561, 1681,	OSUME	0151		1891, 1941, 2631	TANDBERG	0161, 0331, 0611,
	1691	OTTO VERSAND	0021, 0121,	SACCS	1971		1021, 1421, 1771,
MAXIMAL	0071, 1981		0141, 0221,	SAISHO	0451, 0601, 1161,		1791, 2081
MCMICHAEL	1281		0601, 1561,		1241, 1301, 1511,	TANDY	0191, 0451, 1331,
MEDION	2591, 2601, 2611,		1741, 1981		1671, 1681, 1691		1531
	2621, 2641, 2651,	PAEL	0591, 1411	SALORA	0011, 0041, 0061,	TASHIKO	0141
	2661, 2671, 2681,	PANASONIC	0031, 0201, 0211,		0071, 0341, 0451,	TATUNG	0271, 0581, 0601,
	2691, 2711, 2721,		0451, 0701, 1311,		0671, 1291, 1351,		0971, 1101, 1681,
	2761, 2771, 2781		1751, 1961, 2561,		1521, 1561, 1601,		1691
MEMOREX	1511		2741		1641, 1911, 1921,	TCM	2621, 2641, 2711,
METZ	0231, 0741, 1001,	PANORAMIC	2351		1931, 1981, 2321		2761, 2771, 2781
	1041, 1081, 1481,	PATHE MARCONI	0571	SAMBERS	0261, 0491, 0581,	TECHNICS	1311
	2071, 2081	PATHE' CINEMA (F)	0431, 0591,		0641, 1091, 1371,	TECHWOOD	0791
MGA	1231		1621, 1661,		1411, 2001	TEKNIKA	1171, 1231, 1261
MICROMAXX	2591, 2621, 2641,		1971	SAMSUNG	0101, 0601, 0841,	TELE	1141
	2651, 2711, 2761,	PAUSA	1511		0981, 1101, 1181,	TELEAVIA	0571, 0651, 0731,
	2771, 2781	PAUZA	1511		1371, 1511, 2011		1821
MINERVA	0221, 0231, 0491,	PERDIO	0891, 1101	SANYO	0141, 0151, 0401,	TELEFUNKEN	0291, 0301, 0311,
	1381, 2141, 2151	PHILCO	0021, 0491, 0811,		0601, 0801, 0821,		0551, 0731, 1131,
MISTRAL	2281		0981, 1021, 1081,		0981, 1021, 1101,		1471, 1591, 1791,
MITSUBISHI	0141, 0201, 0231,		1401, 1611, 1621,		1111, 1291, 1351,		1801, 1811, 1821,
	0661, 1191, 1201,		1751, 2201, 2251,		1691, 1741, 2051,		1991, 2161, 2171,
	1231, 1671, 1691,		2271, 2451, 2471		2091, 2551		2181, 2191, 2201,
	1741	PHILIPS	0101, 0361, 0591,	SBR	0681, 0751, 1281,		2251, 2271, 2521,
MIVAR	0491, 0501, 0581,		0621, 0681, 0751,		2281		2631
	0591, 0761, 0771,		0761, 1021, 1081,	SCHAUB LORENZ	0451	TELETECH	1511
	1371, 1431, 2031		1281, 2031, 2281,	SCHNEIDER	0021, 0071, 0091,	TEMPEST	2381, 2391, 2401,
MTC	0791		2291, 2431, 2441,		0451, 0511, 0591,		2411
MULTITECH	0261, 0581, 0601,		2511, 2731		0601, 0751, 1321,	TENSAI	1331, 2091
	0641, 0981, 1321,	PHOENIX	1081		1361, 1621, 1641,	TEXET	0601
	1511	PHONOLA	0751, 1081		2101, 2111, 2291	THOMSON	0331, 0481, 0531,
MURPHY	0451, 2091	PIONEER	0291, 0451, 1341,	SCOTT	1171, 1261		0571, 0631, 0651,
MURPHY (UK)	0081, 1031		1821	SEG	0261, 0601, 0821,		0731, 0901, 1241,
N.E.I.	0101, 0961				0991		1571, 1591, 1791,
NAD	1341	PRANDONI-PRINCE	0411, 0451,	SEI	0641, 0691, 1081,		1811, 1821, 1891,
NEC	0141, 1711, 1721,		0491, 0581,		1301, 1481, 1981		1941, 2531
	1731		1411			THORN	0741, 0861, 2091,
		PRANDONI-PROMCE					2251, 2271, 2281
			0451, 0491, 0581				

THORN-FERGUSON 0281, 0371,  
0551, 0651,  
0781, 0861,  
0881, 1131,  
1181, 1361,  
1461, 1971,  
1991, 2281

TMK 0141, 0791, 1471

TOSHIBA 0141, 0381, 0481,  
1221, 1271, 1701,  
1741, 1851, 2151,  
2801, 2811

TRANS CONTINENS  
0451

TRISTAR 2281

TRIUMPH 0481, 0581, 2121

UHER 0431, 0451, 0481,  
0491, 0511, 1311,  
1541

ULTRAVOX 0021, 0261, 0591,  
1021, 1081, 1981

UNIVERSUM 1181, 2051

UNIVOX 1971

VEGAVOX 0811

VEXA 0101, 1511

VICTOR 1441, 1591

VIDEOTON 2481

VORTEC 0101, 0651

VOXSON 0411, 0451, 0491,  
1021, 1081

WALTHAM 0451

WATSON 0431, 2201, 2241

WATT RADIO 0021, 0061, 0261,  
0591, 0641, 0761,  
1091, 1971, 1981,  
2001

WEGA 0141, 1081, 1981

WEGA COLOR 1021

WELTBlick 0101

WESTON 1621

WHITE WESTINGHOUSE  
0101, 0261, 0431,  
0591, 0761, 1401,  
1541

YOKO 0601, 1511

ZANUSSI 0071, 0101, 0351,  
0411, 0451, 0951,  
1901, 2061, 2101,  
2111

ZOPPAS 0451

## CABLE TV

CABLETIME 1446, 1456, 1476

CLYDE CABLEVISION  
1426

FILMNET 1396, 1436

FRANCE TELECOM 1386

GEC 1426

JERROLD 1416

MOVIE TIME 1466

NSC 1466

PHILIPS 1386

PIONEER 0006

SAMSUNG 1496

SCIENTIFIC ATLANTA  
1486, 1506

STARCOM 1416

STS 1466

TANDBERG 1366

TELE 1436

TELE +1 1436

TELESERVICE 1406, 1476

TUDI 1376

UNITED CABLE 1416

ZENITH 1406

## SATELLITE TUNER

AKAI 1276

ALBA 0826, 1276

AMSTRAD 0166, 0796, 1016,  
1026, 1296

ANKARO 0476

AST 0406

ASTRA 0126

BARCOM 0476

BLAUPUNKT 0966

BMC SATELLITE 0106

BRITISH TELECOM 1276

BUSH 0826

BUSH (UK) 0956

CAMBRIDGE 0196, 1276

CANAL PLUS (FRANCE)  
1536

CHAPARRAL 0016, 0696, 1006

COLUMBUS 0616

CONNEXIONS 0306, 0426

DISCUS ELIPSE 0856, 0866

DISKXPRESS 0426, 0476

DRAKE 1516

ECHOSTAR 0226, 0236, 0606,  
0626, 0666, 0926,  
0996, 1046, 1056,  
1066, 1106

ELTA 1286

ELTA SAT 0146

EURODEC 1226, 1236, 1246

FERGUSON 0046, 0176, 0186,  
0296, 0846, 0956,  
1306

FINLUX 0976

FRACARRO 0026, 0536, 0776

FUBA 0476, 0616, 0636,  
1056

GIUCAR RECORD 0206, 0336

GRUNDIG 0176, 0946, 0956,  
0966

HIGH PERFORMANCE  
0916

HIRSCHMANN 0756, 0966

HITACHI 0446, 0516, 0706,  
0946

ICX INTERNATIONAL 0886

ITT 0066, 0126, 0176,  
0446, 1156

ITT/NOKIA 0066, 0126, 0176,  
0446, 1156

JEEMON 0146

JERROLD 0846, 0986

JOHANSSON 0246

JVC 1276

KATHREIN 0116, 0266, 0276,  
0366

KOSMOS 0266

KYOSTAR 1036, 1086

LENG 0246

LIFESAT 1326, 1346, 1356

LUXOR 0126, 0136, 0446,  
0466, 0506, 1156

MACAB 0356

MASPRO 0016, 0116, 0256,  
0956

MEDION 1326, 1346

METZ 0966

MICROMAXX 1326, 1346

MITSUBISHI 0966

MORGANS 0596

MURATTO 0406

MORRIS 0286, 0316, 0766,  
0786, 0836

NETWORK 0046

NIKKO 1136, 1146

NOKIA 0066, 0126, 0176,  
0446, 1156, 1166,  
1336

NORSAT 0786

OTTO VERSAND 0966

PACE 0046, 0176, 0296,  
0936, 0956, 1306,  
1566, 1576

PACE MSS 0946

PALCOM 0616, 0686, 0706

PALSAT 0396

PALTEC 0706

PANASONIC 0806, 1306

PANSAT 1076

PHILIPS 0326, 0346, 0476,  
0956, 1126, 1186,  
1196, 1206, 1216,  
1306, 1316

PROSAT 1176

PTT TELECOM 0306, 0896

QUELLE 0966

RADIX 1056

REDIFFUSION 0316, 0786

RFT 1186, 1196, 1206,  
1216

SAGEM 1256, 1546

SAKURA 0566, 0816

SALORA 0066, 0126, 0136,  
0446, 0456, 0486,  
0496, 0576

SAMSUNG 0746, 0756

SAT 0406

SATCOM 0896

SATECO 0646

SECTOR 1266

SEDEA 1096

SENTRA 0416

SIEMENS 0896, 0966

SINTRACK 0906

SKY DIGITAL BOX 1526

SKYLAB 0476

SKYSCAN 0876

SONY 0736, 0946

STELLA 0306

STRONG 0156, 0396, 1036,  
1086

STV 0636

TANDBERG 1116

TANDY 0916

TANTEC 0616

TATUNG 0516, 0546

TECHNISAT 0086, 0096, 0526,  
0556, 1056

TELECOM 0306

TELEMAX 0586

THORN-FERGUSON 0046, 0076,  
0176, 0186,  
0956

TOSHIBA 0946

TPS (FRANCE) 1546

TRIAD 0406

UNIDEN 0036, 0216, 0676,  
0716, 0726

US ELECTRONICS 0886

VORTEC 0756, 1036, 1076

VTECH 0436

WINERSAT 0246

WISI 0056, 0356, 0376,  
0386, 0406, 0656,  
1056, 1156

WOLSEY 0916

XCOM MULTIMEDIA 1556

XSAT (FRANCE) 1556

ZEHNDER 0266, 0406

ZENDER 0406

## VCR

AIWA 0042, 0352, 0432

AKAI 0042, 0422, 0492,  
0582, 0612, 0642,  
0652, 0762, 0912

ALBA 0002, 0112, 0282,  
0332, 0342, 0972

AMSTRAD 0322, 0432, 0452

ANITECH 0002

ANITSCH 1002

ASA 0012, 0052

AUDIOSONIC 0002

BAIRD 0042, 0282, 0492

BANG & OLUFSEN 0042

BAUR 0052, 0062, 0812

BLAUPUNKT 0062, 0092, 0252,  
0462, 0672, 0992

BRIONVEGA 0032

BUSH 0002, 0282, 0332,  
0342, 0512, 0972

BUSH (UK) 0812

CAPEHART 0112

CGE 0042, 0432, 0762

CRAIG 0072, 0482

CROWN 0112, 0282, 0622

DAEWOO 0112, 0282, 0622

DANSAI 0012

DAYTRON 0112

DECCA 0042, 0052, 0432,  
0942

DECCA (UK) 0052

DEGRAAF 0052, 0132, 0432,  
0532, 0602

DIXI 0442

DUAL 0042, 0632

DUMONT 0052, 0432, 0532

DYNATECH 0432

DYNATRON 0012

ELBE 0122

ELIN 0072

EMERSON 0012, 0162, 0202,  
0432, 0512, 0522  
0012

ERRES 0042, 0712, 0722,  
0852, 0902, 1012,  
1022, 1082

FIDELITY 0432

FINLANDIA 0052, 0532

FINLUX 0012, 0042, 0052,  
0082, 0262, 0382,  
0432, 0462, 0492,  
0532, 0572, 0602,  
0912

FIRST LINE 0002, 0912

FISHER 0162, 0482, 0532,  
0542, 0572, 0592

FORMENTI-PHOENIX  
0012, 0052

FRONTECH 0112

FUNAI 0432

GBC 0002

GEC (UK) 0022, 0052

GELOSO 0002

GENERAL TECHNIC 1172

GOLDSTAR 0012, 0122, 0812,  
0952

GOODMANS 0002, 0072, 0282,  
0432, 0502

GOODMANS (UK) 0002

GRAETZ 0022, 0042

GRANADA 0052, 0132, 0532,  
0572

GRANADA (UK) 0052, 0092,  
0462, 0602,  
0812, 0822



GRUNDIG	0052, 0062, 0092, 0232, 0252, 0262, 0752, 0802	NORDMENDE	0042, 0102, 0142, 0192, 0222, 0242, 0392, 0402, 0632, 0732, 0742, 0762, 0782, 0792, 0832, 0842, 0872	SONY	0432, 0552, 0682, 0692, 0942, 0952, 0962, 1122, 1132
HANSEATIC	0052, 0812	OLYMPUS	0462	STS	0602
HARMAN/KARDON	0122, 0922	OPTONICA	0132, 0502	SUNKAI	0512
HCM	0002	ORION	0162, 0202, 0312, 0442, 0512, 0522, 0982	SUNSTAR	0432
HINARI	0002, 0202, 0412, 0442, 0522	OSAKA	0432	SYLVANIA	0432, 0912
HITACHI	0042, 0172, 0292, 0432, 0602, 0662, 0812, 1022	OSAKI	0002, 0012, 0432	SYMPHONIC	0432, 0912
IMPERIAL	0072, 0432	OTTO VERSAND	0052, 0062, 0812	TANDBERG	0062, 0162, 0522, 0932
INGERSOL	0442	PANASONIC	0022, 0212, 0462, 0672, 0992, 1092, 1102, 1182	TASHIKO	0132, 0432
INNO HIT	0002, 0052, 0072	PENTAX	0172, 0602	TATUNG	0042, 0052, 0432, 0922
INNOVATION	1142, 1162, 1172	PERDIO	0432	TCM	1142, 1162, 1172
INTERFUNK	0022, 0052	PHILCO	1062	TEAC	0042, 0432
IRRADIO	0002, 0012	PHILIPS	0052, 0082, 0092, 0152, 0182, 0362, 0372, 0382, 0472, 0502, 1072	TECHNICS	0462
ITT	0022, 0032, 0042, 0072, 0292, 0492, 0532, 0572, 0762	PHONOLA	0052, 0152	TEKNIKA	0012, 0432
ITT-NOKIA	0022, 0032, 0042, 0072, 0292, 0492, 0532, 0572, 0762	PILOT	0012	TELEFUNKEN	0042, 0192, 0632, 0732, 0742, 0762, 0782, 0882, 0892
JENSEN	0042	PIONEER	0052, 0142, 0372, 0472	TEMPEST	1032, 1042, 1052
JVC	0042, 0102, 0142, 0272, 0742, 0762, 0782, 0902	PORTLAND	0112	TENOSAL	0002
KARCHER	0052, 0072, 0812	PROLINE	0432	THOMSON	0042, 0102, 0142, 0192, 0402, 0632, 0762
KENDO	0492	PYE	0052, 0152	THORN	0042, 0902
KENWOOD	0042, 0142, 0572	QUARTZ	0572	THORN-FERGUSON	0042, 0222, 0302, 0712, 0722, 0742, 0762, 0852, 0862, 0872, 0902
LIFETEC	1142, 1162, 1172	QUELLE	0012, 0032, 0042, 0052, 0062, 0072, 0092, 0202, 0462, 0522, 0942	TMK	0522
LLOYD	0432	RADIONETTE	0022	TONSAI	0002
LOEWE OPTA	0052, 0092, 0152	REALISTIC	0012, 0072, 0132, 0432, 0482, 0502, 0532, 0572	TOSHIBA	0042, 0622, 0912, 1212
LOGIK	0002, 0072, 0442	RET	1072	TOTEVISION	0012, 0072
LUMA	0162	REX	0042, 0742, 0782	TRIUMPH	0922
LUXOR	0492, 0572, 0812	RICOH	0952	UHER	0042, 0072
M ELECTRONIC	0432	SABA	0042, 0142, 0192, 0222, 0242, 0392, 0632, 0732, 0742, 0762, 0772, 0782, 0792, 0872	ULTRAVOX	0032
MAGNADYNE	0052	SAISHO	0162, 0202, 0292, 0442, 0512, 0522, 0972	UNITECH	0072
MAGNASONIC	0572	SALORA	0192, 0572, 0812, 0822, 0912	VECTOR RESEARCH	0122
MANESTH	0012	SAMSUNG	0052, 0072, 0622, 0652, 1192	VICTOR	0042, 0102, 0142
MARANTZ	0012, 0052, 0092, 0122, 0502	SANSUI	0042, 0142	VIDEON	1162, 1172
MARK	0012	SANYO	0482, 0532, 0562, 0572	WELTBlick	0012
MARTA	0012	SBR	0052, 0152, 0182	WHITE WESTINGHOUSE	0032
MATSUI	0012, 0442, 0512, 0522, 0812, 0972	SCHAUB LORENZ	0022, 0042	XENON	0162
MEDION	1142, 1162, 1172	SCHNEIDER	0002, 0012, 0052, 0072, 0432	YOKO	0012, 0062, 0072
MEMOREX	0012, 0132, 0432, 0482, 0532, 0572	SEG	0002, 0072		
METZ	0062, 0092, 0932	SEI-SINUDYNE	0442		
MGA	0912	SELECO	0042		
MICROMAXX	1142, 1162, 1172	SENTRA	0112		
MINERVA	0062, 0092, 0252	SHARP	0132, 0502, 0702		
MINOLTA	0172, 0602	SHINTOM	0002		
MITSUBISHI	0052, 0062, 0142, 0912, 0922	SIEMENS	0062, 0092, 0252, 0572		
MTC	0072, 0432	SINUDYNE	0052, 0382, 0442, 0932		
MULTITECH	0002, 0052, 0062, 0282, 0432	SONOKO	0282		
MURPHY	0432				
N.E.I.	0012, 0052				
NATIONAL	0462				
NEC	0042, 0122, 0142, 1202				
NECKERMANN	0032, 0042, 0052, 0072, 0092, 0202, 0522, 0572, 0762, 0812				
NIKKAI	0112				
NOBLIKO	0092				
NOKIA	0022, 0032, 0042, 0072, 0292, 0492, 0532, 0572, 0762, 1152				

---

## LD PLAYER

AIWA	0137
FUNAI	0137
HITACHI	0047
MAGNAVOX	0077
PANASONIC	0027
PIONEER	0037
RCA	0067
REALISTIC	0137
SAMSUNG	0017, 0087
SONY	0057, 0097, 0107, 0117
VICTOR	0127
YAMAHA	0007

---

## CD PLAYER

ACCUPHASE	0315
ADC	0865
ADCOM	0785, 1015
AKAI	0115, 0125, 0725, 0735, 0745, 0935, 1155
ARCAM	1875
ARCAM-ROTEL	0165
AUDIO-TECHNICA	0835
AUDIOSONIC	0155
AIWA	1105, 1235, 1245, 1765, 1915, 1935
BSR	0875
CALIFORNIA AUDIO LAB	1075
CARRERA	0555, 0875
CARVER	0825, 1415
CYRUS-ROTEL	0205
DENON	0045, 0955, 1045, 1595, 1795, 1805
DUAL	1005
ELIN	0185
EMERSON	1015, 1285, 1675
FISHER	0105, 0595, 0605, 0825, 1165, 1175
GENEXXA	0525, 0825, 0855, 0875, 0995, 1265, 1285, 1345, 1355, 1485, 1575, 1675, 1715, 1825
GOLDSTAR	0555, 1185, 1195, 1585
GRUNDIG	0175
HARMAN KARDON	0325, 0495, 0565, 1135, 1145, 1155
HITACHI	0065, 0585, 0685, 0945, 1005, 1015, 1225, 1545
INNOVATION	1995, 2005, 2015
ITT-NOKIA	0185
JVC	0385, 0395, 0455, 0575, 0585
KARCHER	0485
KENWOOD	0025, 0055, 0145, 0215, 0595, 0675, 0695, 0705, 0715, 0925, 1355, 1485, 1575, 1675, 1715, 1825
KORTING	0175
LIFETEC	2015
LIGHT CONTROL	1155, 1645, 1655, 1665
LINN	0165, 1875
LUXMAN	0265, 0275, 0795, 0805, 1295, 1305, 1555, 1925

---

## DVD PLAYER

AKAI	0108
JVC	0168, 0348
KENWOOD	0288
MAGNAVOX	0248
MITSUBISHI	0268
ONKYO	0128, 0248
PANASONIC	0048
PHILIPS	0188, 0248
PIONEER	0208, 0228
PROSCAN	0308
RCA	0308
SAMSUNG	0148
SHARP	0068
SONY	0028
TECHNICS	0048
THOMSON	0328
TOSHIBA	0088, 0248
YAMAHA	0008, 0048
ZENITH	0248

LUXOR 0185, 1895, 1905  
 MAGNAVOX 1865, 1875  
 MARANTZ 0165, 0175, 0545,  
 0665, 1275, 1335,  
 1405, 1505, 1875,  
 1955  
 MATSUSHITA 1095, 1605  
 MCS 0535  
 MEDION 0075, 1995, 2005,  
 2015  
 MEMOREX 0525, 1015, 1265,  
 1275, 1285, 1675  
 MGA 1125  
 MICROMAXX 2015  
 MISSION 0165, 1875  
 MITSUBISHI 1125, 1205  
 NAD 0135, 0255, 0285,  
 0295, 0305, 0345,  
 0755, 0765, 1315,  
 1325  
 NAKAMICHI 0635, 0645, 1565  
 NEC 0405, 0535, 0775,  
 0785  
 NECKERMAN 0155, 0225  
 NIKKO 0835, 1165  
 OCEANIC 0185  
 OKANO 0155, 0225  
 ONKYO 0885, 1385, 1425,  
 1455, 1515  
 PANASONIC 1055, 1075, 1615,  
 1625  
 PHILIPS 0165, 0175, 0195,  
 1865, 1875  
 PIONEER 0095, 0335, 0425,  
 0435, 0445, 0525,  
 0855, 1035, 1945  
 PROTON 0905, 1875  
 QUASAR 1075  
 RADIOLA 1845, 1855  
 RADIOTONE 0485  
 REALISTIC 0825, 1015, 1265,  
 1275, 1285, 1575  
 ROTEL 1875  
 SABA 1005  
 SAE 1875  
 SALORA 0185  
 SANSUI 0415, 0965, 0975,  
 0985, 1255, 1675,  
 1875  
 SANYO 0625, 0825, 0845,  
 0915  
 SCHNEIDER 1845, 1855  
 SCOTT 1285, 1675  
 SHARP 0025, 0035, 1025,  
 1115, 1275, 1635,  
 1785, 1815, 1825,  
 1835  
 SHERWOOD 1275, 1445  
 SIEMENS 1085  
 SIGNATURE 1155  
 SONY 0345, 0355, 0365,  
 0375, 0865, 1685,  
 1695, 1705, 1715,  
 1725, 1735, 1745  
 SYLVANIA 1875  
 TANDBERG 1885  
 TASHIKO 1525  
 TCM 1985, 2015  
 TEAC 0235, 0245, 1275,  
 1365, 1375, 1395,  
 1435, 1465, 1475  
 TECHNICS 0465, 0475, 1065,  
 1075, 1625  
 TELEFUNKEN 1005  
 THETA DIGITAL 1865

THOMSON 1005  
 TOSHIBA 0755, 0765  
 VECTOR RESEARCH  
 0555, 0865  
 VICTOR 0575  
 YAMAHA 0005, 0015, 1815

---

### MD RECORDER

YAMAHA 0024, 0224  
 KENWOOD 0214  
 SONY 0224

---

### TAPE DECK

AKAI 0124  
 DENON 0204  
 GRUNDIG 0134  
 HARMAN 0044  
 JVC 0194  
 KENWOOD 0164  
 KORTING 0134  
 LUXMAN 0054, 0064, 0074,  
 0084  
 MARANTZ 0134, 0144  
 NAD 0174  
 ONKYO 0184  
 PHILIPS 0134, 0144, 0154  
 PIONEER 0034, 0114  
 SONY 0094, 0104  
 YAMAHA 0004, 0014



---

**YAMAHA ELECTRONICS CORPORATION, USA** 6660 ORANGETHORPE AVE., BUENA PARK, CALIF. 90620, U.S.A.  
**YAMAHA CANADA MUSIC LTD.** 135 MILNER AVE., SCARBOROUGH, ONTARIO M1S 3R1, CANADA  
**YAMAHA ELECTRONIK EUROPA G.m.b.H.** SIEMENSSTR. 22-34, 25462 RELINGEN BEI HAMBURG, F.R. OF GERMANY  
**YAMAHA ELECTRONIQUE FRANCE S.A.** RUE AMBROISE CROIZAT BP70 CROISSY-BEAUBOURG 77312 MARNE-LA-VALLEE CEDEX02, FRANCE  
**YAMAHA ELECTRONICS (UK) LTD.** YAMAHA HOUSE, 200 RICKMANSWORTH ROAD WATFORD, HERTS WD1 7JS, ENGLAND  
**YAMAHA SCANDINAVIA A.B.** J A WETTERGRENS GATA 1, BOX 30053, 400 43 VÄSTRA FRÖLUNDA, SWEDEN  
**YAMAHA MUSIC AUSTRALIA PTY, LTD.** 17-33 MARKET ST., SOUTH MELBOURNE, 3205 VIC., AUSTRALIA

**YAMAHA CORPORATION**  
Printed in Malaysia ID V471930-1

**Quick Reference Card**

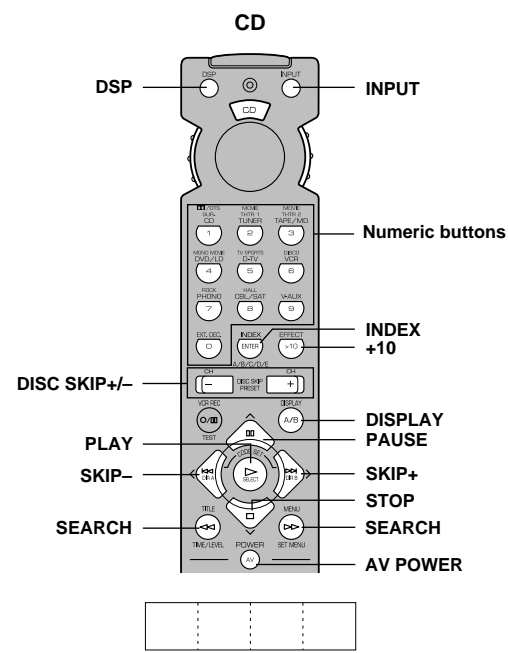
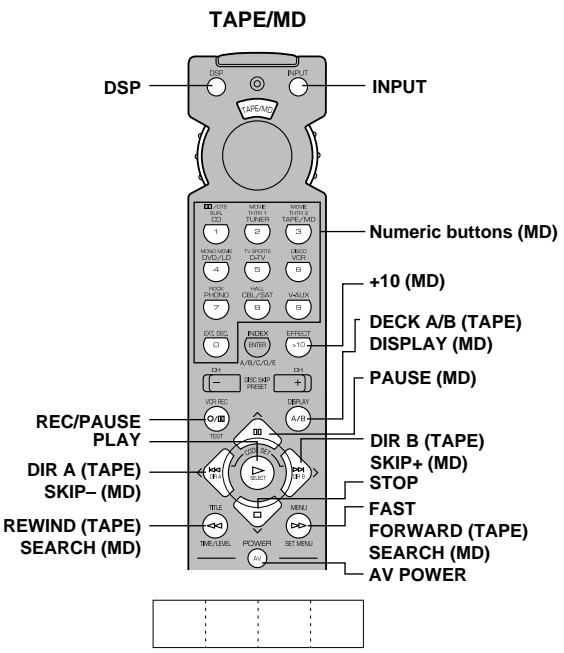
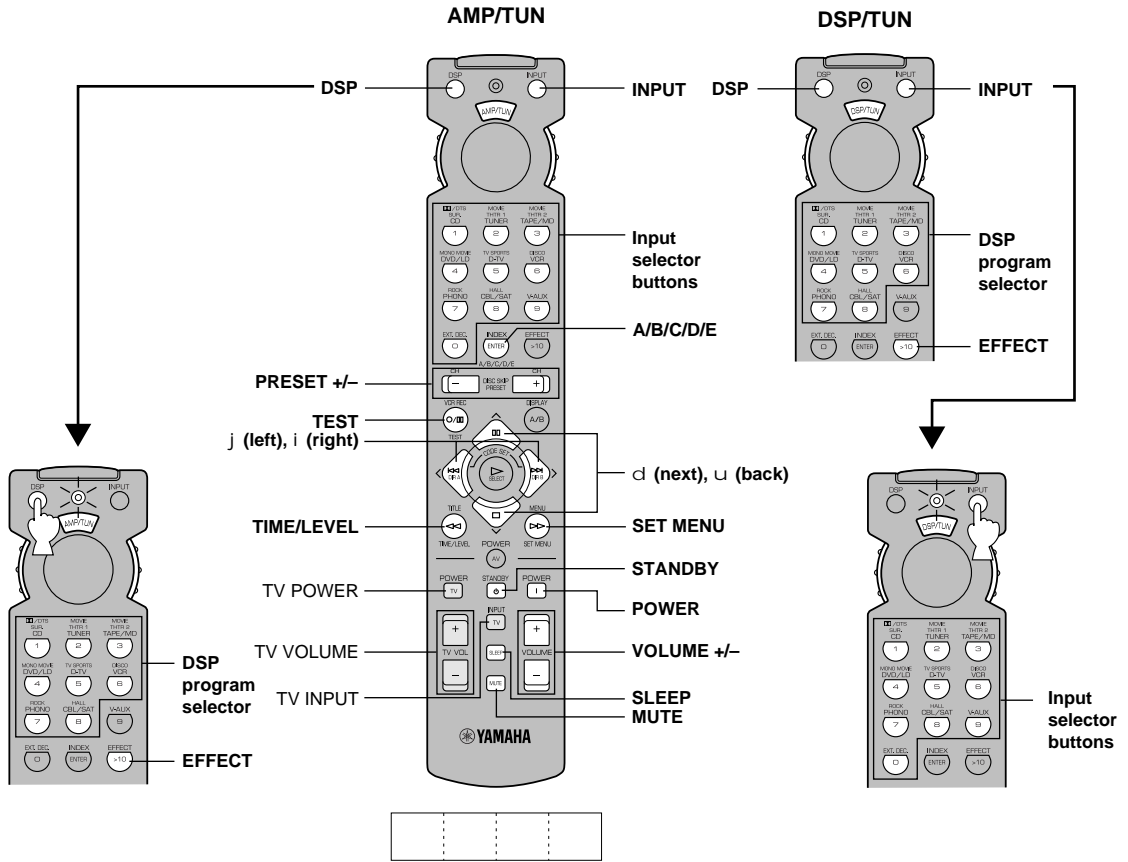

# Quick Reference Card

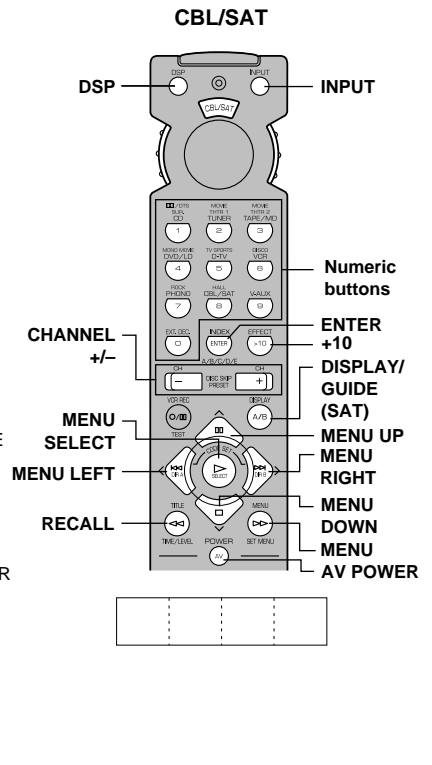
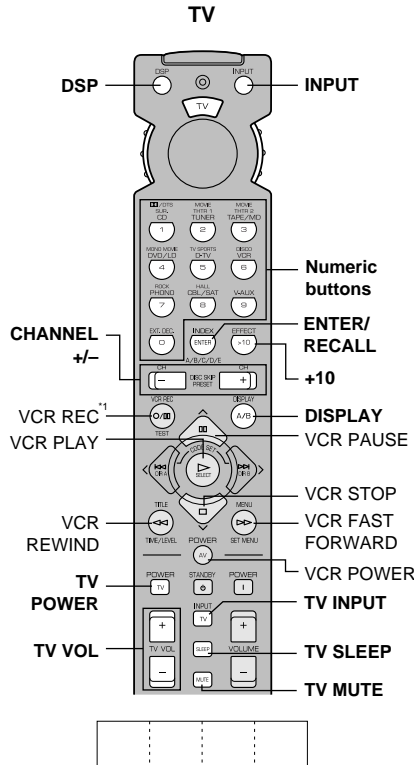
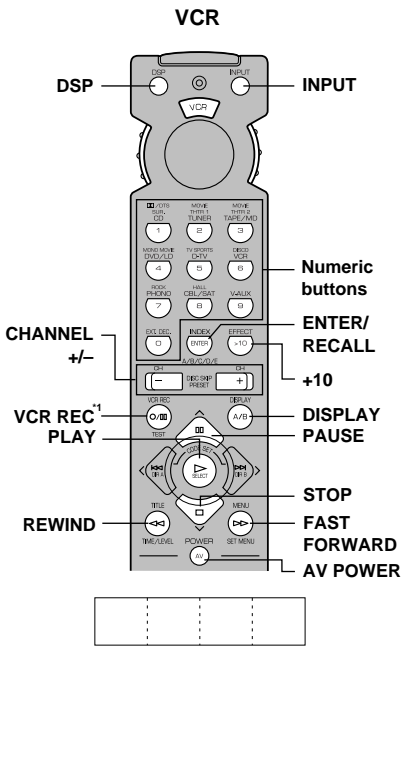
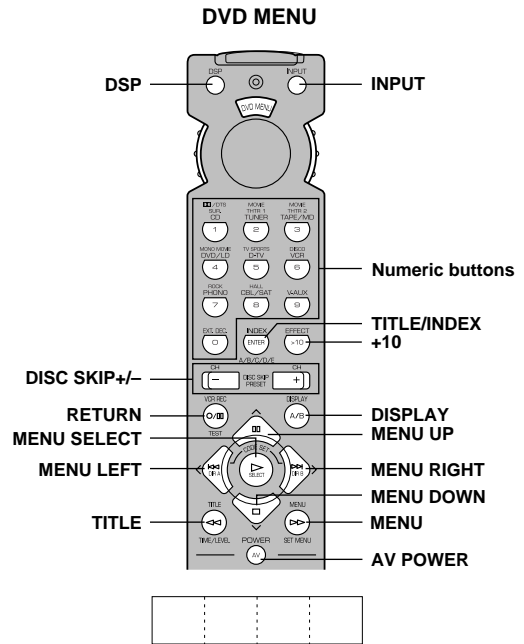
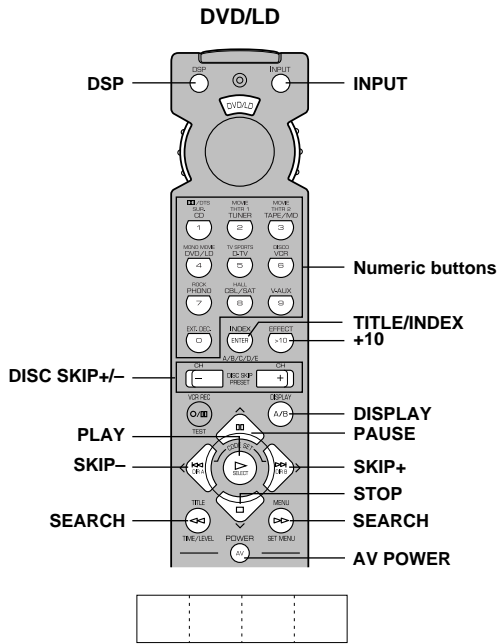

\*1 Press this button twice to start recording.  
Appuyer deux fois sur cette touche pour commencer l'enregistrement.  
Drücken Sie diese Taste zweimal, um die Aufnahme zu starten.  
Tryck två gånger på den här knappen för att börja spela in.

Premere due volte questo tasto per iniziare la registrazione.  
Presione dos veces este botón para empezar a grabar.  
Druk tweemaal op deze toets om met opnemen te beginnen.  
按此按钮两次即可开始录像。

# Connection Guide (when listening to a digital 5.1-channel source)

