

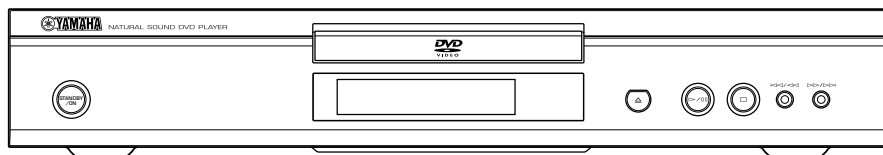

DVD / VIDEO CD / CD PLAYER
LECTEUR DE DVD

DVD-S530

*OWNER'S MANUAL
MODE D'EMPLOI*





This symbol warns the user that uninsulated voltage within the unit may have sufficient magnitude to cause electric shock. Therefore, it is dangerous to make any kind of contact with any inside part of this unit.



This symbol alerts the user that important literature concerning the operation and maintenance of this unit has been included. Therefore, it should be read carefully in order to avoid any problems.

WARNING

To reduce the risk of fire or electric shock, do not expose this appliance to rain or moisture.

CAUTION

Use of controls or adjustments or performance of procedures other than herein may result in hazardous radiation exposure.

The set complies with the FCC-Rules, Part 15 and with 21 CFR 1040.10.

IMPORTANT SAFETY INSTRUCTIONS

1. Read these instructions.
2. Keep these instructions.
3. Heed all warnings.
4. Follow all instructions.
5. Do not use this apparatus near water.
6. Clean only with a dry cloth.
7. Do not block any of the ventilation openings. Install in accordance with the manufacturers instructions.
8. Do not install near any heat sources such as radiators, heat registers, stoves, or other apparatus (including amplifiers) that produce heat.
9. Do not defeat the safety purpose of the polarized or grounding-type plug. A polarized plug has two blades with one wider than the other. A grounding type plug has two blades and a third grounding prong. The wide blade or the third prong are provided for your safety. When the provided plug does not fit into your outlet, consult an electrician for replacement of the obsolete outlet.
10. Protect the power cord from being walked on or pinched, particularly at plugs, convenience receptacles, and the point where they exit from the apparatus.
11. Only use attachments/accessories specified by the manufacturer.
12.  Use only with a cart, stand, tripod, bracket, or table specified by the manufacturer or sold with the apparatus. When a cart is used, use caution when moving the cart/apparatus combination to avoid injury from tip-over.
13. Unplug this apparatus during lightning storms or when unused for long periods of time.
14. Refer all servicing to qualified service personnel. Servicing is required when the apparatus has been damaged in any way, such as if the power-supply cord or plug is damaged, liquid has been spilled or objects have fallen into the apparatus, or when the apparatus has been exposed to rain or moisture, does not operate normally, or has been dropped.
15. Battery usage **CAUTION** – To prevent battery leakage which may result in bodily injury or damage to the unit. Install **all** batteries correctly, + and - as marked on the unit. Do not mix batteries (**old** and **new** or **carbon** and **alkaline**, etc.). Remove batteries when the unit is not used for a long time.

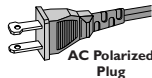

AC Polarized Plug

EL 6475-E002: 01/3

FCC INFORMATION (for US customers only)

1. IMPORTANT NOTICE: DO NOT MODIFY THIS UNIT!

This product, when installed as indicated in the instructions contained in this manual, meets FCC requirements. Modifications not expressly approved by Yamaha may void your authority, granted by the FCC, to use the product.

2. IMPORTANT: When connecting this product to accessories and/or another product use only high quality shielded cables. Cable/s supplied with this product MUST be used. Follow all installation instructions. Failure to follow instructions could void your FCC authorization to use this product in the USA.

3. NOTE: This product has been tested and found to comply with the requirements listed in FCC Regulations, Part 15 for Class "B" digital devices. Compliance with these requirements provides a reasonable level of assurance that your use of this product in a residential environment will not result in harmful interference with other electronic devices. This equipment generates/uses radio frequencies and, if not installed and used according to the instructions found in the users manual, may cause interference harmful to the operation of other electronic devices. Compliance with FCC regulations does not guarantee that interference will not occur in all installations. If this product is found to be the source of interference, which can be determined by turning the product "OFF" and "ON", please try to eliminate the problem by using one of the following measures: Relocate either this product or the device that is being affected by the interference.

Utilize power outlets that are on different branch (circuit breaker or fuse) circuits or install AC line filter/s.

In the case of radio or TV interference, relocate/reorient the antenna. If the antenna lead-in is 300 ohm ribbon lead, change the lead-in to coaxial type cable.

If these corrective measures do not produce satisfactory results, please contact the local retailer authorized to distribute this type of product. If you can not locate the appropriate retailer, please contact Yamaha Electronics Corp., 6600 Orangethorpe Ave. Buena Park, CA90622.

The above statements apply ONLY to those products distributed by Yamaha Corporation of America or its subsidiaries.

We Want You Listening For A Lifetime

YAMAHA and the Electronic Industries Association's Consumer Electronics Group want you to get the most out of your equipment by playing it at a safe level. One that lets the sound come through loud and clear without annoying blaring or distortion - and, most importantly, without affecting your sensitive hearing.

Since hearing damage from loud sounds is often undetectable until it is too late, YAMAHA and the Electronic Industries Association's Consumer Electronics Group recommend you to avoid prolonged exposure from excessive volume levels.



For Customer Use:

Read carefully the information located at the rear panel of the player and enter below the Serial No. Retain this information for future reference.

Model No. _____

Serial No. _____

FOR CANADIAN CUSTOMERS

To prevent electric shock, match wide blade of plug to wide slot and fully insert.

This Class B digital apparatus complies with Canadian ICES-003.

This digital apparatus does not exceed the Class B limits for radio noise emissions from digital apparatus as set out in the Radio Interference Regulations of the Canadian Department of Communications.

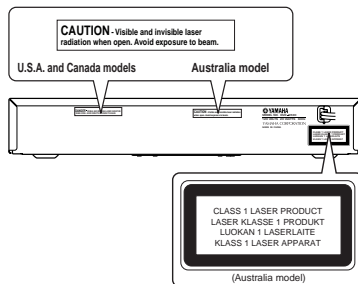

CAUTION

Use of controls or adjustments or performance of procedures other than those specified herein may result in hazardous radiation exposure.

CAUTION: READ THIS BEFORE OPERATING YOUR UNIT.

- 1 To assure the finest performance, please read this manual carefully. Keep it in a safe place for future reference.
- 2 Install this unit in a well ventilated, cool, dry, clean place — away from direct sunlight, heat sources, vibration, dust, moisture, or cold. In a cabinet, allow about 2.5cm (1 inch) of free space all around this unit for adequate ventilation.
- 3 Locate this unit away from other electrical appliances, motors, or transformers to avoid humming sounds.
- 4 Do not expose this unit to sudden temperature changes from cold to hot, nor locate this unit in an environment with high humidity (i.e., a room with a humidifier) to prevent condensation inside this unit, which may cause an electrical shock, fire, damage to this unit, and/or personal injury.
- 5 Avoid installing this unit in a location where foreign objects may fall onto this unit or where this unit may be exposed to liquid dripping or splashing. On the top of this unit, do not place:
 - Other components, as they may cause damage and/or discoloration on the surface of this unit.
 - Burning objects (i.e., candles), as they may cause fire, damage to this unit, and/or personal injury.
 - Containers with liquid in them, as they may fall, spilling the liquid and causing an electrical shock to the user and/or damage to this unit.
- 6 Do not cover this unit with a newspaper, tablecloth, curtain, etc. in order not to obstruct heat radiation. If the temperature inside this unit rises, it may cause fire, damage to this unit, and/or personal injury.
- 7 Do not plug in this unit to a wall outlet until all connections are complete.
- 8 Do not operate this unit upside-down. It may overheat, possibly causing damage.
- 9 Do not use excessive force on switches, knobs and/or cords.
- 10 When disconnecting the power cord from the wall outlet, grasp the plug; do not pull the cord.
- 11 Do not clean this unit with chemical solvents; this might damage the finish. Use a clean, dry cloth.
- 12 Use only the voltage specified on this unit. Using this unit with a higher voltage than specified is dangerous and may cause fire, damage to this unit, and/or personal injury. YAMAHA will not be held responsible for any damage resulting from use of this unit with a voltage other than as specified.
- 13 To prevent damage by lightning, disconnect the power cord from the wall outlet during an electrical storm.
- 14 Do not attempt to modify or fix this unit. Contact qualified YAMAHA service personnel when any service is needed. The cabinet should never be opened for any reason.
- 15 When not planning to use this unit for long periods of time (i.e., vacation), disconnect the AC power plug from the wall outlet.
- 16 Be sure to read the "TROUBLESHOOTING" section on common operating errors before concluding that this unit is faulty.
- 17 Before moving this unit, press STANBY/ON to set the unit in standby mode, then disconnect the AC power plug from the wall outlet.

WARNING

TO REDUCE THE RISK OF FIRE OR ELECTRIC SHOCK, DO NOT EXPOSE THIS UNIT TO RAIN OR MOISTURE.

NOTE:

Pictures shown maybe different between countries. Never make or change connections with the power switched on.

When playing DTS encoded CDs, excessive noise will be heard from the analog stereo outputs. To avoid possible damage to the audio system, the consumer should take proper precautions when the analog stereo outputs of the player are connected to an amplification system. To enjoy DTS Digital Surround™ playback, an external 5.1-channel DTS Digital Surround™ decoder system must be connected to the digital output of the player.

LASER SAFETY

This unit employs a laser. Due to possible eye injury, only a qualified service person should remove the cover or attempt to service this device.

CAUTION

VISIBLE AND INVISIBLE LASER RADIATION WHEN OPEN. AVOID EXPOSURE TO BEAM (WARNING LOCATION: INSIDE ON LASER COVERS/SHIELD OR THE BACKPLATE OF SET)

LASER

Type	Semiconductor laser GaAlAs
Wave length	650 nm (DVD) 780 nm (VCD/CD)
Output Power	7 mW (DVD) 10 mW (VCD/CD)
Beam divergence	60 degree

TruSurround and the SRS symbol are trademarks of SRS Labs., Inc. TruSurround technology is incorporated under license from SRS Labs., Inc.



Manufactured under license from Dolby Laboratories. "Dolby" and the double-D symbol are trademarks of Dolby Laboratories.

"DTS" and "DTS Digital Out" are trademarks of Digital Theater Systems, Inc.

This product incorporates copyright protection technology that is protected by method claims of certain U.S. patents and other intellectual property rights owned by Macrovision Corporation and other rights owners. Use of this copyright protection technology must be authorized by Macrovision Corporation, and is intended for home and other limited viewing uses only unless otherwise authorized by Macrovision Corporation. Reverse engineering or disassembly is prohibited.

Introduction

Environmental Information	2
Supplied accessories	2
Notes about Discs	2
Symbols Used in this Manual	2

Functional Overview

Front and Rear Panels	3
Remote Control	4

Preparation

General Notes on connections	5
Digital Connections	5
Analog Connections	5
Video Connections	6
Inserting batteries into the Remote Control ---	7
NTSC/PAL Conversion	7
Turning on the power	7
General Explanation	7
Menu Bars on video monitor	8
User Preference Settings	8

Operation

Basic Playback	12
Playing a DVD-Video	12
Playing a Video CD	13
Playing an Audio CD	13
Special DVD Features	13
Special VCD & SVCD Features	14
Special CD & MP3 Features	14
General Features	14
MP3 Disc Features	18

Access Control

Child Lock  	19
Parental Control 	19

Troubleshooting

Troubleshooting	21
-----------------------	----

Specifications

Specifications	22
----------------------	----

Introduction

Thank you for purchasing this unit. This Owner's Manual explains the basic operation of this unit.

The region code is 1 for U.S.A and Canada models, 4 for the Australia model.

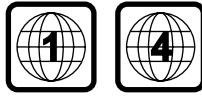

Since it is usual for DVD movies to be released at different times in different regions of the world, all players have region codes and discs can have an optional region code. This unit can play discs containing the identical region code, or mentioned as region "ALL". If you load a disc of a different region code to this unit, you will see the region code notice on the screen. The disc will not playback, and should be unloaded.

Environmental Information

This unit consists of materials which can be recycled and reused if disassembled by a specialised company. Please observe the local regulations regarding the disposal of packaging materials, exhausted batteries and old equipment.

Supplied accessories

- Remote control
- Batteries (two AA size) for remote control
- Audio/Video cable
- Owner's Manual

Notes about Discs



- *This unit is designed for use with DVD video, Video CD, Super video CD, Audio CD (CD text supported), CD-R and CD-RW (MP3 Supported), DVD+RW and DVD+R.*
- *CD-R and CD-RW cannot be played unless finalized.*
- *Only the first session of multisession discs is supported.*
- *Some discs cannot be played depending on the disc characteristics or recording conditions.*
- *Be sure to use only CD-R and CD-RW discs made by reliable manufacturers.*
- *Do not use any non standard shaped discs (heart, etc.)*
- *Do not use disc with tape, scals, or paste on it, damage to the unit may result.*
- *Do not use a disc printed on its surface by a commercially available label printer.*

Cleaning Discs

- When a disc becomes dirty, clean it with a cleaning cloth. Wipe the disc from the centre out. Do not wipe in a circular motion.
- Do not use solvents such as benzine, thinner, commercially available cleaners, or antistatic spray intended for analog records.

Symbols Used in this Manual

The below symbols appear in some headings and notes with the following meanings:

	- Description refers to playback of DVD-video discs
	- Description refers to playback of Video CDs
	- Description refers to playback of Audio CDs

- **Some DVD video discs require specific functions or allow only limited functions during playback.**
- **“” may appears on the video monitor which means that the function is not available on that specific DVD video disc.**

Front and Rear Panels

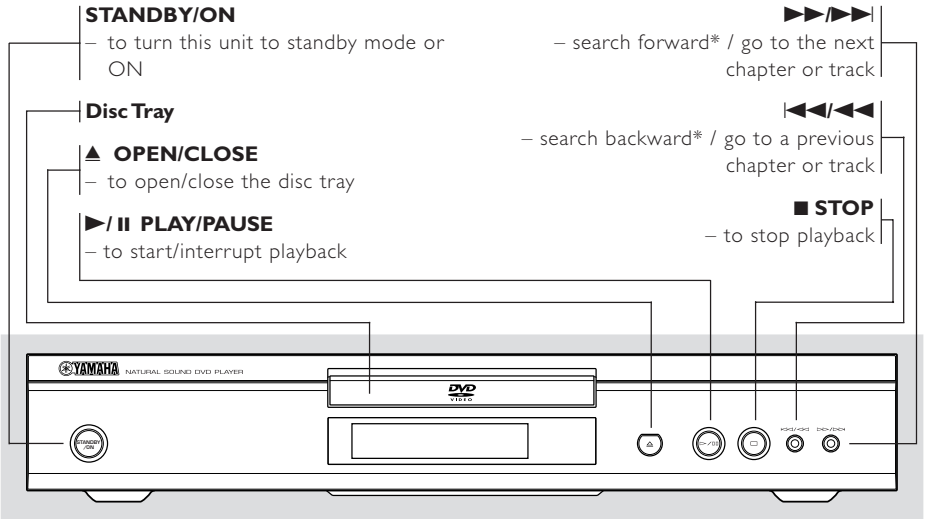

* Press button for about 2 seconds

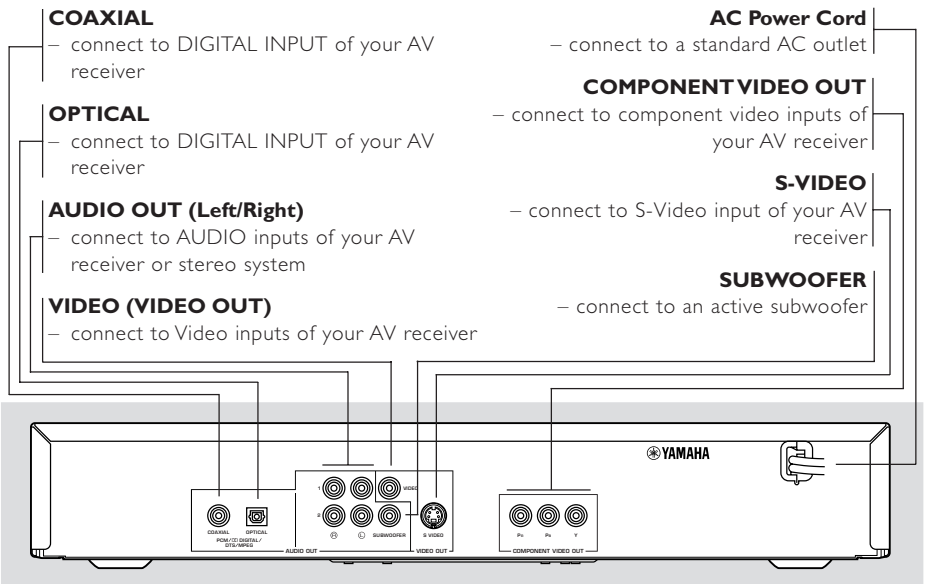

Caution: Do not touch the inner pins of the jacks on the rear panel. Electrostatic discharge may cause permanent damage to the unit.

Functional Overview

Remote Control

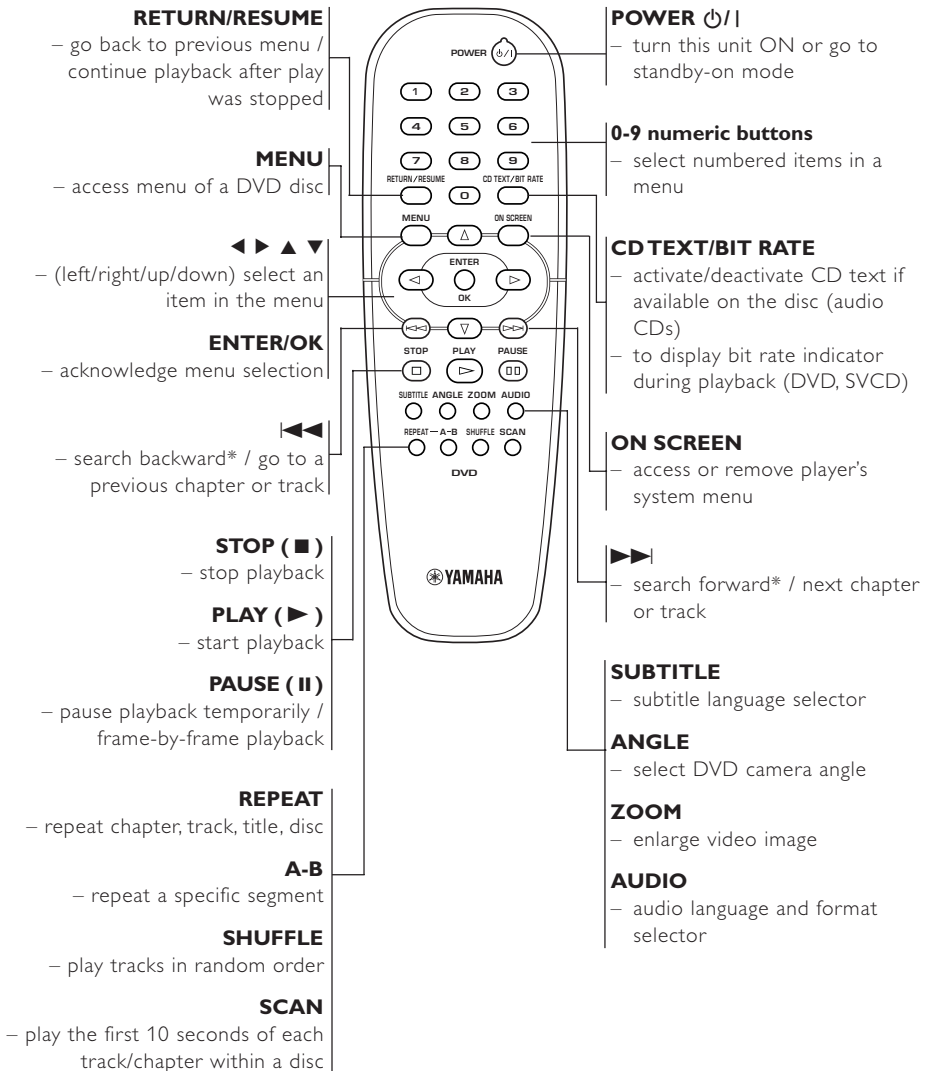

* Press and hold button for about two seconds

General Notes on connections

- Depending on the equipment you wish to connect, there are various ways you could connect this unit. Possible connections are shown in the following drawings.
- Please refer to the manuals of other equipment as necessary to make the best connections.
- Do not connect this unit via your VCR. The video quality could be distorted by the copy protection system.
- Do not connect this unit's audio out jack to the phono in jack of your audio system.

Digital Connections

This unit has COAXIAL and OPTICAL digital out jacks. Connect one or both of them to your AV receiver equipped with Dolby digital, DTS, or MPEG decoder using each specific cable (separate purchase).

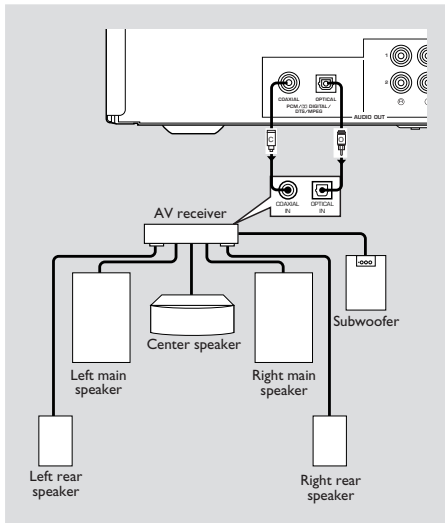

You will need to set this unit's digital output to ALL (see 'User Preference Settings').

Note:

- If the audio format of the digital output does not match the capabilities of your receiver, the receiver will produce a strong, distorted sound or no sound at all. Make sure to select the appropriate audio format at menu screen included on the disc. Pressing **AUDIO** once or more may change not only audio languages but also audio formats, and the selected format appears for several seconds on the status window.
- MP3 Audio is not available on the Digital Output.

Analog Connections

Use audio/video cable supplied with this unit to connect AUDIO OUT L (left) and R (right) jacks of this unit to corresponding input jacks of your audio equipment such as Stereo amplifier. You can connect a subwoofer to this unit's SUBWOOFER jack.

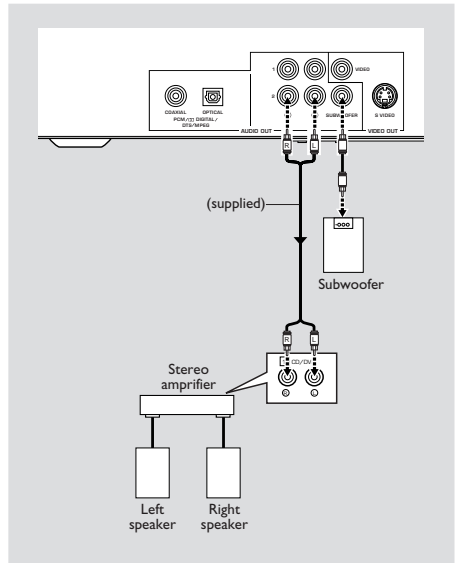

Preparation

Video Connections

If your AV receiver has video output jacks, connect your receiver (and then to your TV) so that you can use one TV for several different video sources (LD, VCR etc.) by simply switching the input source selector of your receiver. The player has three types of video output jacks. Use one of them in accordance with the input jacks of the equipment to be connected.

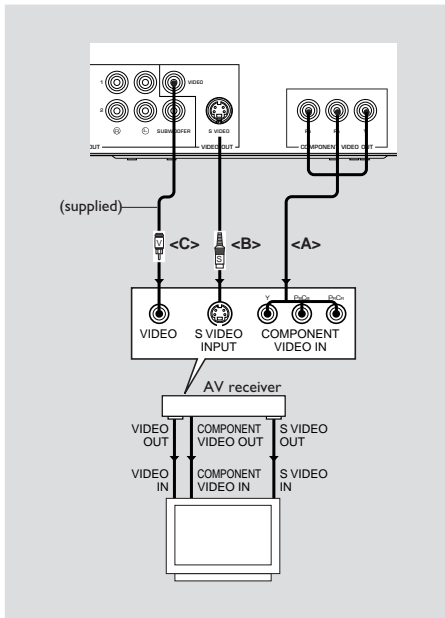

Component Video terminal <A>

Component video connection achieves high fidelity in reproducing colors (better performance than S-video connection), separating video signal into luminance (Y, terminal color-coded as green), and color difference (Pb, blue/Pr, red). Use commercially available coaxial cables. Receiver (and TV) with component input is required. Observe the color of each jack when connecting. If your receiver does not have component output jacks, connecting the player's component output directly to your TV's component input can reproduce better video image.

S-Video terminal

S (separate) video connection achieves a clearer picture than composite video connection by separating color and luminance when transmitting signals. Use commercially available S-video cable. Receiver (and TV) with S-video input is required.

Composite Video terminal (1, 2) <C>

Use audio/video cable supplied with this unit when connecting the player to a TV. VIDEO 1, 2 jacks of VIDEO OUT output the same signal. You can connect one to your receiver's input using supplied Audio/Video cable, and the other to another receiver or a TV.

Inserting batteries into the Remote Control

- 1 Open the battery cover.
- 2 Insert batteries (AA size) with the correct polarity as indicated by the + and - symbols inside the battery compartment.
- 3 Close the cover.

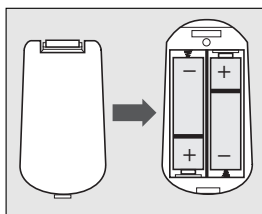

CAUTION

- Remove batteries if they are exhausted or not to be used for a long time.
- Do not use old and new or different types of batteries in combination.
- Batteries contain chemical substances, so they should be disposed off properly and kept away from children.

Using the Remote Control

- Direct the remote control at the remote sensor of this unit.
- Do not drop the remote control.
- Do not leave the remote control near extremely hot or humid place.
- Do not spill water or put anything wet on the remote control.

NTSC/PAL Conversion

This unit is equipped with an NTSC/PAL conversion feature that converts the video output of the disc to match your TV system. To activate the conversion refer to page 9.

Turning on the power

- 1 Connect the AC power cord to the power outlet.
- 2 Turn on the TV and your AV receiver.
- 3 Select the appropriate input source at the AV receiver that was used to connect to this unit. Refer to the equipment owner's manual for detail.
- 4 Turn this unit on.
- 5 Set the TV to the correct Video IN channel. (eg. EXT1, EXT2, AV1, AV2, AUDIO/VIDEO, etc. (Refer to your TV owner's manual for detail)
 - The front display lights up and the default screen appears on the TV.

General Explanation

About this Manual

This manual gives the basic instructions for operating this unit. Some DVDs require specific operation or allow only limited operation during playback which may not respond to all operating commands. When this occurs, the symbol ✕ appears on the video monitor, indicating that the operation is not permitted by this unit or the disc.

Remote control operation

Unless stated, all operations can be carried out with the remote control. Always point the remote control directly at the player, making sure there are no obstructions in the path of the infrared beam.

Corresponding buttons on the front panel can also be used.

Preparation

Menu Bars on video monitor

- Operations can be carried out directly via the multiple menu bars on the video monitor:
- The following functions are available via the menu bars. Pressing ON SCREEN repeatedly will toggle through menu bar 1, menu bar 2, menu bar 3 and menu bar OFF:

Menu bar 1



From the left,
 User Preference Settings →
 Current Subtitle Language →
 Current Audio Language → Smart Color →
 Sound Mode

Menu bar 2



From the left,
 Frame by Frame → Slow Motion → Scan Speeds
 → Camera Angle → Enlarge Picture

Menu bar 3



From the left,
 Title → Chapter → Time Search →
 Favorite Track Selection

Temporary Feedback Field Icons

These icons will appear temporarily on the top left hand corner of your video monitor:

scan	Scan	A-	Repeat A to end
repeat	Repeat All	A-B	Repeat A-B
title	Repeat Title	1/3	Angle
track	Repeat Track	locked	Child Lock On
chapter	Repeat Chapter	safe	Child Safe
shuffle	Shuffle	resume	Resume
shuffle	Shuffle Repeat	action prohibited	Action Prohibited

User Preference Settings

In the User Preference Settings menu, you can customize this unit to suit your own particular requirements.

General operation:

- 1 Press ON SCREEN.
- 2 The will be highlighted in the menu bar.
- 3 Press ▼ to activate the User Preference Settings menu.
- 4 Use ◀▶▲▼ to toggle through the functions and select your preferred option.
- 5 Press ENTER/OK to confirm a highlighted selection.

The following items are available:

Picture

– TV Shape

Select the aspect ratio of the TV to be connected.

4:3 letterbox → when you connect a normal TV. Displays a wide picture with bands displayed on the upper and lower portions of the video monitor:

4:3 panscan → when you connect a normal TV. Displays the wide picture on the whole video monitor with a portion automatically cut off.

16:9 → when you connect a wide-screen TV.

**4:3
letterbox**



**4:3
panscan**



16:9

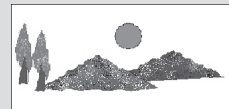

Note:

- Panscan is subject to availability on the disc.

– Black level shift (NTSC output only)

Select On for adapting the color dynamics to obtain richer contrasts.

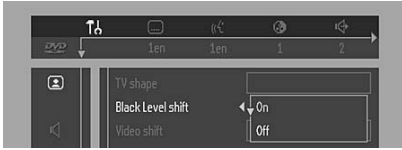

– Monitor Type

Allows you to select the type of display device that is connected to this unit.

In each device, a set of predefined Color settings is available or choose Personal that allows you to select the color settings according to your preference.

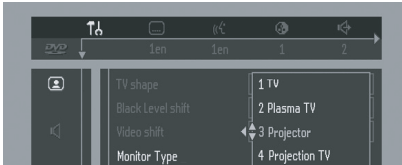

– Video shift

Use this setting to personalize the position of the picture on your TV by scrolling it to the left or right.

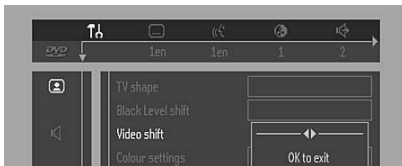

– Color settings (Smart Color)

You can select one of four predefined sets of color settings and one set (Personal) which you can define yourself.

You can also switch the settings by accessing the  in the menu bar:

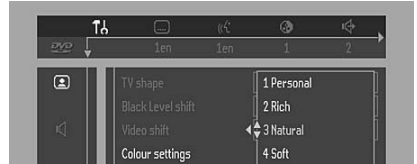

- When Personal is selected, it allows you to fine-tune saturation, brightness and contrast.
- Use ▲ or ▼ to adjust the values of these parameters.

– TV System (NTSC/PAL Conversion)

Allows you to select between PAL, NTSC and AUTO mode depending on your TV.

The conversions supported are as follows:

Type	Disc	Output format		
		Selected mode		
	Format	NTSC	PAL	AUTO
DVD	NTSC	NTSC	PAL 60	NTSC
	PAL	Not Supported	PAL	PAL
VCD	NTSC	NTSC	PAL 60	NTSC
	PAL	NTSC	PAL	PAL

Press ▲ or ▼ to select PAL, NTSC or AUTO.

Notes:

- AUTO can only be selected when using a TV that has both the NTSC and PAL systems.
- Slight picture distortions may occur due to this conversion. This is normal. Thus, the AUTO format is most suitable for the best picture quality.

Preparation

Sound

– Digital output

- Digital output selection enables you to specify the type of digital output suitable for your receiver:
- Select All (default setting), if you had connected your COAXIAL / OPTICAL AUDIO OUT to a multichannel decoder receiver.
- Select PCM only if your receiver is not capable of decoding multichannel audio.
- Select Off to deactivate the COAXIAL / OPTICAL AUDIO OUT.

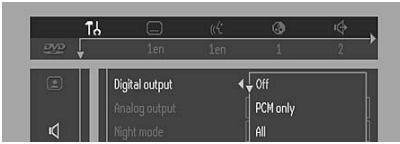

– Analog output

Select Stereo, Dolby Surr-compat (Dolby Surround compatible) or 3D Sound (Trusurround) output to match your system's playback capability.

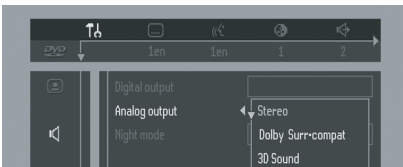

– Night Mode

When set to On, the dynamics of your sound output are optimized. High volume outputs are softened, enabling you to watch your favorite action movie, etc. without disturbing others.

– Karaoke vocal

Put this setting to On only when a multi-channel karaoke DVD is being played. The karaoke channels on the disc will then be mixed into a normal stereo sound.

– Sub-woofer Cut-off

The frequency of the subwoofer output can be set to High (200Hz) or Low (100Hz) to match your system's playback sound quality.

– PCM Output

Allows to select PCM digital output between 48kHz and 96kHz. When 48kHz has been selected, 96kHz (if available on disc) PCM data stream will be converted to 48kHz. Some 96kHz DVD are copy protected. If your PCM output selection is 96kHz, the digital output will be muted to comply with the standards. Select 48kHz to enable digital output.

Language

Selecting disc languages:

Menu/Audio/Subtitle language

- This is to select the audio language, subtitle language and the language used in video monitor menus or DVD menus which will always be used for every disc to be played back.
- If the language selected is not available on the disc, the original language designated by each disc will be selected.

Features

– Access control

Access control contains the following features:
 Child Lock - When Child Lock is set to on, a 4-digit code needs to be entered in order to play discs.

Parental level - Allows the conditional presentation of DVDs containing Parental Control information (see page 19 and 20, 'Access Control' section).

– Status window

Displays the current status of this unit and appears with the menu bar. When disc playback is stopped, it is displayed with the 'Temporary Feedback Field' in the default screen.

Factory setting is On. Select Off to suppress display of the Status window.



– PBC (Playback Control - for VCD)

The Playback Control can be set to On or Off.

– Beeper

The beeper can be set to On or Off.

– Help text

When set to On, help text describes the icons selected. Select Off if you no longer require the help text.

– Smart Power-off

Puts this unit to standby after a predefined time. This can be set to Enabled or Disabled.

Operation

Basic Playback

- 1 Press **STANDBY/ON** on the front panel.
- 2 Press **▲** (**OPEN/CLOSE**) on the front panel to open disc loading tray.
- 3 Place the chosen disc in the tray, with the label facing up.
- 4 Press **▲** (**OPEN/CLOSE**) again to close the tray.
→ **READING** appears on the front display, and playback starts automatically.

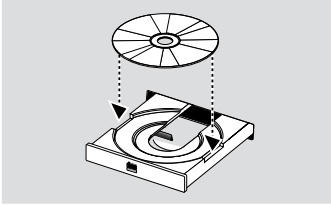

Notes:

- DVDs may have a region code. This unit will not play discs that have a region code different from the region code of this unit.
- If 'Child Lock' is set to ON and the disc inserted is not authorized, the 4-digit code must be entered and/or the disc must be authorized (see Access Control).

Playing a DVD-Video

- DVD video discs may have one or more TITLES, and each TITLE may have one or more CHAPTERS.
- Playback stops at the end of each TITLE.

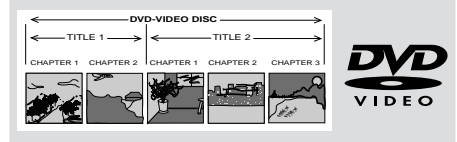

Playing a title

- 1 Insert a disc and close the tray, playback starts automatically.
→ The Video monitor's and display shows the type of disc loaded, disc's information and playing time.
- 2 When the disc menu appear on the video monitor; use **▼▲▶** or numeric buttons on the remote control to select an option and continue playback.
- 3 If the titles are numbered, press the numeric buttons or use **▼▲** to select desired title in the menubar.
- 4 To stop playback, press **STOP**.

Resume

- In stop mode and when a disc has not been ejected,
→ Pressing **PLAY** will automatically resume playback from the point where the playback was last stopped.

To deactivate resume,

- Press **STOP** to stop playback.
→ The help line text appears "Press Stop again to start from beginning" for 5 seconds.
- Press **STOP** again or unload the discs, the resume is canceled.

To activate resume,

- Reload the disc and press **PLAY**.
→ Playback starts from the beginning of the title.
- When resume icon **▶** appears on the screen, press **PLAY** again.
→ Playback will resume from the point where the playback was last stopped.

Note:

- Resume feature is also applicable to VCDs and SVCDs when Playback control is turned off.

Playing a Video CD

- Video CDs may have one or more TRACKS, and TRACKS may have one or more INDEXES.
- To make easy and convenient access, you can move between TRACKS and INDEXES.
- Some Video CDs have Play Back Control (PBC), which is a predefined playback sequence stored on the disc (see *Playback Control*).

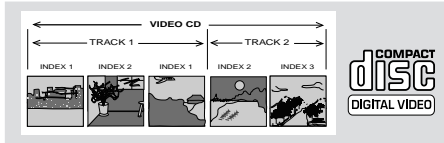

Playing a disc

- 1 Insert the disc and close the tray, playback starts automatically.
 - The number of tracks of the disc will appear on the Video monitor and the front display.
- 2 Press PLAY.
 - The current track number and its elapsed playing time will be displayed.
- 3 Playback will stop at the end of the disc.
- 4 To stop playback, press STOP.
- 5 Resume feature is also applicable for VCDs and SVCDs (see *Resume section*).

Playing an Audio CD

- Audio CDs contain only TRACKS.
- They can be played on this unit with the audio output connected to a stereo system or to your TV.
- If CD-text is available on the disc, it will be display on both the Video monitor and the front display.
- Select tracks using the menubar on the Video monitor or by pressing the numeric buttons directly.
- This unit also allows you to compile Favorite Track Selection (FTS) programs for your discs by selecting or excluding tracks of your choice (see *FTS Program - Audio CDs*).

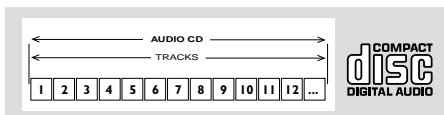

Playing a disc

- 1 Insert a disc and close the tray, playback starts automatically.
 - The video monitor will display the number of tracks for selection and current playing status.
- 2 Playback will stop at the end of the disc.
- 3 To stop playback, press STOP.

Special DVD Features

DVDs may contain menus to navigate the disc and access special features. Press the appropriate numeric buttons or use **▼**, **▲**, **▶**, **◀** to highlight your selection in the DVD menu and press ENTER/OK to confirm.

Title/Disc menu

- 1 Press MENU.
 - If the current title has a menu, the menu will appear on the screen. Otherwise, the disc menu will be displayed.
- 2 If disc menu is available on the disc, audio language, subtitle options, chapters for the title and other options will appear for selection.
- 3 To remove the title/disc menu, press MENU again.

Camera Angle

Some discs contain scenes which have been shot simultaneously from various angles.

This unit allows you to select the desired camera angle.

- When this unit encounters a scene shot in multiple angles, it will give an indication on the "Temporary Feedback Field"
 - The angle icon remains displayed until multiple angles are no longer available.
- Use **▲**/**▼** to select the required angle.
 - Playback changes to the selected angle.
- You can also select **↔** in the menu bar or press ANGLE on the remote control directly.

Changing the audio formats and/or language

- 1 Select **⏏** in the menu bar or press AUDIO on the remote control directly.
- 2 Press AUDIO or **▲**/**▼** repeatedly to select the different formats and/or languages.

Operation

Subtitles

- 1 Select  in the menu bar or press SUBTITLE on the remote control directly.
- 2 Press SUBTITLE or ▲/▼ repeatedly to select the different subtitles.

Special VCD & SVCD Features

Playback Control (PBC)

- 1 Load a Video CD with PBC and press PLAY.
- 2 Go through the menu with the buttons indicated on the Video monitor until your chosen passage starts to playback. If a PBC menu consists of a list of tracks, you can select a track directly.
- 3 Enter your choice with the numeric buttons.
- 4 Press RETURN/RESUME to go back to the previous menu, if applicable on the menu.
- 5 You may also select PBC off under Personal Preferences.
→ When set to off, PBC menus are not activated for further playback.

Note:

When PBC is on, you cannot operate resume, shuffle, repeat, A-B repeat, scan, time search and FTS.

Special CD & MP3 Features

CD text and MP3 text

- 1 Some CD or MP3-CD discs may contain text information (eg. track name, album name, artist name etc.) which will appear on the front display and video monitor during playback.
- 2 By default, CD text display is set to ON.
- 3 To switch off the CD text display, press CD TEXT/BIT RATE during playback.
- 4 Press CD TEXT/BIT RATE again to switch on the text display mode.



play	track	time	total tracks	total time
	11	2:34	14	5:29:78

Disc: The Best of Me
Artist: Bryan Adams
Track: Everything I do

General Features

Note:

– Unless stated, all operations described are based on remote control use. Some operations can be carried out using the menu bar on the Video monitor.

Moving to another title/chapter

DVD VCD

When a disc has more than one title/track or chapter; you can move to another title/chapter as follows:

- 1 Press ON SCREEN, then select T or C in the menu bar.
- 2 Press ▲/▼ or numeric buttons to select a title/chapter:

CD

- 1 Press ►► or ◀◀ briefly during playback to go to the next track or to return to the beginning of the current track respectively.
- 2 Press ◀◀ twice briefly to step back to the previous track.
- 3 To go directly to any track, enter the track number using the numeric buttons.

Note:

– Long press of the ►► or ◀◀ will switch on backward or forward search (see search section).

Search

DVD VCD

- 1 Select  in the menu bar and press ▼.
- 2 Use ◀/▶ to select the required speed: -32, -8 or -4 (backward), or +4, +8, +32 (forward).
- 3 Select 1 or press PLAY to play the disc at normal speed again.
- To exit the search mode, press ▲.
(Playback continues at the selected speed.)

CD

- To search forward or backward through different tracks, you can also hold down ►► or ◀◀ for more than two seconds.

Slow Motion

- 1 Select  in the menu bar and press \blacktriangledown .
→ Playback will pause.
- 2 Use $\blacktriangleleft\blacktriangleright$ to select the required speed: -1, -1/2, -1/4 or -1/8 (backward), or +1/8, +1/4, +1/2 or +1 (forward).
- 3 Select 1 or press PLAY to play the disc at normal speed again.
- 4 If **II** is pressed, the speed will be set to zero (PAUSE).
- To exit the slow motion mode, press \blacktriangle .
(Playback continues at the selected speed.)

Still Picture and Frame-by-frame playback

- 1 Select  in the menu bar and press \blacktriangledown .
→ Playback will pause.
- 2 Use $\blacktriangleleft\blacktriangleright$ to select the previous or next picture frame.
- Press PLAY to play the disc at normal speed again.

Note:

– You can also activate frame-by-frame playback by pressing PAUSE repeatedly.

Scan

Scanning plays the first 10 seconds of each chapter/track on the disc.

- 1 Press SCAN.
- 2 To continue playback at your chosen chapter/track, press SCAN again or press PLAY.

Repeat

Repeat chapter/title/disc

Each time you press REPEAT, the front display changes as follows:

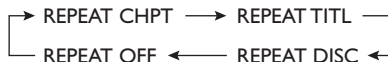

REPEAT CHPT*: repeat the current chapter

REPEAT TITL: repeat the current title

REPEAT DISC*: repeat the entire disc

REPEAT OFF: exit repeat mode

* This feature may not be available with some discs.

Repeat track/disc

Each time you press REPEAT, the front display changes as follows:



REPEAT TRK: repeat the current track

REPEAT DISC: repeat the entire disc

REPEAT OFF: exit repeat mode

Repeat A-B

- DVD-Video Discs: repeat a sequence in a title
- Video and Audio CDs: repeat a sequence in a track

- 1 Press A-B at your chosen starting point.
- 2 Press A-B again at your chosen end point.
→ REPEAT A B appears briefly on the front display, and the repeat sequence begins.
- 3 To exit the sequence, press A-B.

Operation

Shuffle

DVD

This shuffles the playing order of chapters within a title, if the title has more than one chapter.

- 1 Press SHUFFLE during playback.
→ SHUFFLE appears on the front display for about two seconds.
- 2 To return to normal playback, press Shuffle again.

VCD CD

This shuffles the playing order of tracks within a disc, if the disc has more than one tracks.

- 1 Press SHUFFLE during playback.
→ SHUFFLE appears on the front display for about two seconds.
- 2 To return to normal playback, press SHUFFLE again.

Time search

The Time Search function allows you to start playing at any chosen time on the disc.

- 1 Select  in the menu bar and press **▼**.
→ Playback will pause.
→ The elapsed playing time is displayed in a time edit box.
- 2 Enter hours, minutes and seconds from left to right in the time edit box using the numeric buttons.
→ Each time an item has been entered, the next item will be highlighted.
- 3 Press ENTER/OK to confirm the selected time.
→ The time edit box will disappear and playback starts from the selected time position on the disc.

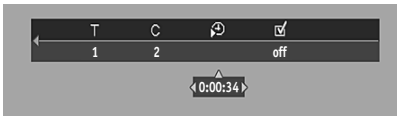

- 4 Press ON SCREEN to remove the menu bar.

Zoom

DVD VCD

The Zoom function allows you to enlarge the video image and to pan through the enlarged image.

- 1 Select  in the menu bar.
- 2 Press **▲/▼** to activate the zoom function and select the required zoom factor: 1.33 or 2 or 4.
→ Playback will continue.
→ The selected zoom factor and 'Press OK to pan' appears below the menu bar.
→ The zoomed picture will appear on the video monitor.
- 3 Press ENTER/OK to confirm the selection.
→ The panning icon appears on the screen.
- 4 Use **◀▶▲▼** to pan across the screen.
- 5 When ENTER/OK is pressed only the panned picture will be shown on the screen.
- 6 To exit zoom mode, select zoom factor to "Off" (zoom factor 1) in the menu bar:



FTS Video/Audio Program

- Favorite Track Selection (FTS) list contains up to 20 items (titles, chapters).
- The most recent program list will be placed on top of the existing list.
 - * This feature may not be available with some discs.

DVD VCD

Storing a Program

- 1 Select  in the menu bar.
- 2 Press **▼** to open the menu bar.
→ The FTS (Favorite Track Selection) menu appears.

Storing titles/tracks

- 1 Press ▲/▼ to select Title/Track.
- 2 Use ► and ◀ to select the require title/tracks.
- 3 Press ENTER/OK to store the entire selected title/tracks.
→ The title number will be added to the list of selections.

Storing chapters/indexes

- 1 Press ▲/▼ to select Chapter/Index.
- 2 Use ► and ◀ to select the required chapter number.
→ The chapter/indexes number will be highlighted.
- 3 Press ENTER/OK to confirm the selection.
→ The selected chapter/indexes number will be added to the list of selections.
- 4 Press ON SCREEN to exit the FTS menu.



Storing a Program

- 1 Load a disc and stop playback.
- 2 Press ▼ to go to the list of available tracks.
- 3 Use ► and ◀ to select the required tracks or directly using the numeric buttons.
- 4 Press ENTER/OK to store the selected tracks.
→ The track number will be added to the list of selections.



Erasing a selection in a Program

- 1 Select in the menu bar:
- 2 Use ▼ to select Program.
- 3 Use ► and ◀ to select the required number.
- 4 Press ENTER/OK to erase the selection.
- 5 Press ON SCREEN to exit.

Erasing all selections

- 1 Select in the menu bar:
- 2 Use ▼ to select Clear all and press ENTER/OK.
→ All selections will be erased.
- 3 Press ON SCREEN to exit.



Switching a Program ON/OFF

- 1 Press ▲ to select FTS.
- 2 Press ► or ◀ to select either ON or OFF.

Bit Rate Indicator

Press the CD TEXT/BIT RATE to activate the bit rate indicator. When activated, the bit rate for video and audio, as well as the total bit rate is displayed. This is only applicable during playback of DVD and SVCD discs.

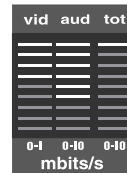

Operation

MP3 Disc Features

Support following MP3-CD formats (ISO9660 format):

- Max. 30 characters (file names or directory)
- Max. nested directory is 8 levels
- The max. album (directory) number is 32
- Supported VBR bit-rate
- Supported sampling frequencies for MP3 disc are: 32 kHz, 44.1 kHz, 48 kHz
- Supported Bit-rates of MP3 disc are: 32, 64, 96, 128, 192, 256 (kbps)

Following formats can't be supported

- The files like *.WMA, *.AAC, *.DLF, *.M3U, *.PLS
- Chinese filenames
- The non-session closed discs
- The discs recorded under UDF format

Downloading MP3 files from the Internet or copying songs from your own legal discs is a delicate process.

Sound Quality	Bit Rate	Approximate Reduction Ratio	Approximate total MP3-CD time	Comment
FM radio	32 kbps	40 : 1	40 hrs	Sound quality significantly affected – not recommended.
FM radio	64 kbps	20 : 1	20 hrs	
Near-CD	96 kbps	15 : 1	15 hrs	Balanced sound quality – compression rate
CD-like	128 kbps	10 : 1	10 hrs	
CD ⁺	256 kbps	5 : 1	5 hrs	Compression rate low – suggest to play CDs instead
CD ⁺	320 kbps	3 : 1	3 hrs	

You may experience an occasional “skip” while listening to your MP3 files. This is normal.

Additional note for MP3 disc Playback:

- In compliance with the SDML, digital-out is muted while playing MP3 discs.
- Due to the recording nature of Digital Audio MP3 (DAM), only Digital Audio music will play.
- The disc reading time may exceed 10 seconds due to the large number of songs compiled onto one disc.
- Only the first session of multisession discs is supported.
- Some MP3 discs cannot be played depending on the disc characteristics or recording conditions.

Album/Title

This feature allows you to view and select the next or previous MP3 disc Album/Title.

- 1 Press ▲/▼ to scroll through the previous or next Album.
- 2 Press ◀▶ to scroll through the previous or next Track.
- 3 You can also select the desired album/track number directly using the numeric buttons.

Note:

- In STOP mode: numbers are used for album selection.
- In PLAY mode: numbers are used for track selection.

- Only the following functions are possible for MP3 discs:
 - STOP / PLAY / PAUSE
 - SKIP NEXT / PREVIOUS
 - REPEAT (TRACK / ALBUM / DISC)

Repeat track/album/Disc

Each time you press REPEAT, the front display changes as follows;

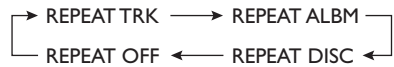

REPEAT TRK: repeat a track





REPEAT ALBM: repeat an album

REPEAT DISC: repeat the entire disc

REPEAT OFF: exit repeat mode

Child Lock

Activating/deactivating the Child Lock

- 1 When disc playback is stopped, select Access control in the User Preference Settings menu using ▲/▼.
- 2 Enter a 4-digit code of your own choice twice.
- 3 Move to "Child lock" using ▲/▼.
- 4 Move to  /  using ▶.
- 5 Select  using ▲.
- 6 Press ENTER/OK or ◀ to confirm, then press ON SCREEN to exit the User Preference Settings menu.
 - Now unauthorized discs will not be played unless the 4-digit code is entered.
- 7 Select  to deactivate the child lock.

Notes:

Confirmation of the 4-digit code is necessary when:

- The code is entered for the very first time (see above),
- The code is changed or canceled (see 'Changing the 4-digit code'),

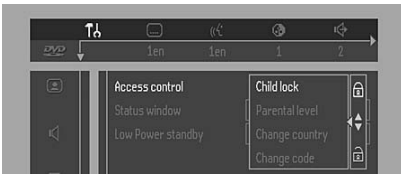

Authorizing discs

- 1 Insert the disc.
 - The 'child safe' dialog will appear.
- 2 You will be asked to enter your secret code for 'Play once' or 'Play always.'
- If 'Play once', disc can be played when in this unit and this unit is turned on.
- If 'Play always', disc will become authorized and can always be played, even if the child lock is set to on.



Notes:

- This unit memory can maintain 80 authorized ('child safe') disc titles. A disc will be placed in the list when 'Play always' is selected.
- Each time a 'child safe' disc is played, it will be placed on top of the list. When the list is full, the last disc in the list will be replaced when a new disc is added.

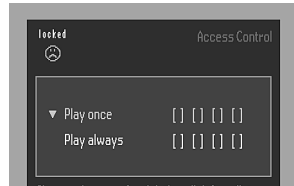
- Double-sided DVDs and multi-volume VCDs may have a different ID for each side. In order to make the disc 'child safe', each side has to be authorized.



Deauthorizing discs

- 1 Insert the disc.
 - Playback starts automatically.
- 2 Press ■ while  is visible.
 - The  will appear and the disc is now deauthorized.

Notes:

Playback continues even after you have deauthorized the disc. Press ■ if you want to stop it.

Parental Control

Movies may contain scenes not suitable for children. Therefore, discs may contain 'Parental Control' information which applies to the complete disc or to certain scenes on the disc. These scenes are rated from 0 to 8, and alternative, more suitable scenes are available on the disc. Ratings are country dependent. The 'Parental Control' feature allows you to prevent discs from being played by your children or to have certain discs played with alternative scenes.

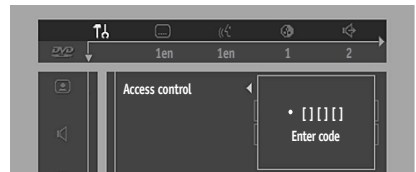

Access Control

Activating/Deactivating Parental Control

- 1 When disc playback is stopped, select Access control in the User Preference Settings menu using ▲/▼.
- 2 Enter your 4-digit code. If necessary, enter the code a second time.
- 3 Move to Parental level using ▲/▼.
- 4 Move to value adjustment ('-' -') using ►.
- 5 Then use ▲/▼ or the numeric buttons on the remote control to select a rating from 0 to 8 for the disc inserted.

Rating 0 (displayed as '- -'):

Parental control is not activated. The disc will be played in full.

Ratings 1 to 8:

The disc contains scenes not suitable for children. If you set a rating, all scenes with the same rating or lower will be played. Higher rated scenes will not be played unless an alternative which has the same rating or lower is available on the disc. If no suitable alternative is found, playback will stop and the 4-digit code has to be entered.

- 6 Press ENTER/OK or ◀ to confirm, then press ◀ again to exit the User Preference Settings menu.



Country

- 1 When disc playback is stopped, select Access control in the User Preference Settings menu using ▲/▼.
- 2 Enter the 4-digit code.
- 3 Move to Change country using ▲/▼.
- 4 Press ►.
- 5 Select a country using ▲/▼.
- 6 Press ENTER/OK or ◀ to confirm, then press ◀ again to exit the menu.

Changing the 4-digit code

- 1 When disc playback is stopped, select Access control in the User Preference Settings menu using ▲/▼.
- 2 Enter the current 4 digit code.
- 3 Move to Change code using ▼ and press ►.
- 4 Enter the new 4-digit code.
- 5 Enter the code a second time.
- 6 Press ◀ to exit the menu.
→ The new 4 digit code will take effect.

If you forget your 4 digit code

- 1 Press ■ to exit the 'Child Safe' screen.
- 2 Select Access control in the User Preference Settings menu using ▲/▼.
- 3 The 4-digit code can be canceled by pressing ■ four times in the 'Access control' dialog.
- 4 You can then enter a new code (twice!) as described above in 'Changing the 4 digit code'.

Parental Control Disclaimer

This unit features the parental control system which is to activate when playing DVD discs which is to activate when playing DVD discs furnished with certain software coding only. Also note that at the time of release of this unit certain aspects of the technical standards had not been settled between set makers and the disc industries.

On this basis, YAMAHA cannot guarantee the functioning of the parental control system and denies any liability associated with unintended watching of disc content.

If in doubt, please make sure the disc plays according to your parental control settings before you allow children access to this unit.

Refer to the chart below when this unit does not function properly. If the problem you are experiencing is not listed below or if the instruction below does not help, set this unit to the standby mode, disconnect the power cord, and contact the nearest authorized YAMAHA dealer or service center.

Problem	Solution
No power	<ul style="list-style-type: none"> – Check if the AC power cord is properly connected. – Press Standby-On button on this unit.
No picture	<ul style="list-style-type: none"> – Check if the TV is switched on. – Check the video connection.
Distorted picture	<ul style="list-style-type: none"> – Check the disc for fingerprints and clean the disc with a soft cloth, wiping from the centre to the edge. – Sometimes a small amount of picture distortion may appear. This is not a malfunction.
Completely distorted picture or black/white picture with DVD or Video CD	<ul style="list-style-type: none"> – Make sure the NTSC/PAL setting at this unit matches the video signal of your television. (See NTSC/PAL Settings) – The disc format does not match your TV's video signal (PAL/NTSC).
No sound or distorted sound	<ul style="list-style-type: none"> – Adjust the volume. – Check that the speakers are connected correctly. – Select another audio language (if available on the DVD video disc)
No audio at digital output	<ul style="list-style-type: none"> – Check the digital connections. – Check the settings menu to make sure the digital output is set to All or PCM only. – Check if the audio format of the selected audio language matches your receiver capabilities. – MP3 Audio is not available on the Digital Output.
Disc can't be played.	<ul style="list-style-type: none"> – Ensure the disc label is facing up. – Clean the disc. – Check if the disc is defective by trying another disc. – Check if the disc is badly scratched or warped (not flat). – Check the disc for the correct region code.
Picture freezes momentarily during playback	<ul style="list-style-type: none"> – Check the disc for fingerprints/scratches and clean with a soft cloth wiping from centre to edge.
No return to start-up screen when disc is removed	<ul style="list-style-type: none"> – Reset the unit by switching this unit off, then on again.
This unit does not respond to the remote control.	<ul style="list-style-type: none"> – Aim the remote control directly at the sensor on the front of this unit. – Reduce the distance to this unit. – Replace the batteries in the remote control. – Re-insert the batteries with their polarities (+/– signs) as indicated.
Buttons do not work or this unit stops responding.	<ul style="list-style-type: none"> – To completely reset this unit, unplug the AC cord from the AC outlet for 5-10 seconds.
This unit does not respond to some operating commands during playback.	<ul style="list-style-type: none"> – Operations may not be permitted by the disc. Refer to the instructions of the disc.
This unit does not respond to any command when turned on for the first time.	<ul style="list-style-type: none"> – Turn on your TV and follow the procedures on the screen to decide initial setup items.

Specifications

PLAYBACK SYSTEM

DVD Video
DVD+RW
DVD+R
Video CD and SVCD
CD (CD-R and CD-RW)
MP3 CD

TV STANDARD (PAL/50Hz) (NTSC/60Hz)

Number of lines	625	525
Playback	Multistandard	(PAL/NTSC)

VIDEO PERFORMANCE

Video output	1 Vpp into 75 ohm
S-Video output	Y: 1 Vpp into 75 ohm C: 0.3 Vpp into 75 ohm
Component video output	Y: 1 Vpp into 75 ohm P _B /C _B P _R /C _R : 0.7 Vpp into 75 ohm
Black Level Shift	On/Off
Video Shift	Left/Right

AUDIO FORMAT

Digital	MPEG	Compressed Digital
	DTS/Dolby Digital	
	PCM	16, 20, 24 bits fs, 44.1, 48, 96 kHz

Analog Sound Stereo
Dolby Pro Logic downmix from Dolby Digital multi-channel sound
3D Sound (TruSurround) for virtual 5.1 channel sound on 2 speakers

AUDIO PERFORMANCE

DA Converter	24 bits	
DVD	fs 96 kHz	2 Hz - 44 kHz
DVD	fs 48 kHz	2 Hz - 22 kHz
VCD/CD	fs 44.1 kHz	2 Hz - 20 kHz
Signal-Noise (1kHz)		105 dB
Dynamic Range (1kHz)		100 dB
Distortion and Noise (1kHz)		0.0030%
MPEG MP3		MPEG Audio L3

CONNECTIONS

Y Output	Cinch (green)
Pb/Cb Output	Cinch (blue)
Pr/Cr Output	Cinch (red)
S-Video Output	Mini DIN, 4 pins
Video Output	Cinch (yellow)
Audio L+R output	Cinch (white/red)
Audio Subwoofer	Cinch (black)
Digital Output	1 coaxial, 1 optical IEC958 for CDDA / LPCM IEC1937 for MPEG1/2, Dolby Digital, DTS

GENERAL

Dimensions (w x h x d)	435 x 75 x 302 mm
Weight	Approximately 2.8 Kg
POWER SUPPLY	
U.S.A. and Canada models	120 V, 60 Hz
Australia model	240 V, 50 Hz
POWER CONSUMPTION	17 W (3W in standby mode)

Specifications subject to change without prior notice.



YAMAHA ELECTRONICS CORPORATION, USA 6660 ORANGETHORPE AVE., BUENA PARK, CALIF. 90620, U.S.A.
YAMAHA CANADA MUSIC LTD. 135 MILNER AVE., SCARBOROUGH, ONTARIO M1S 3R1, CANADA
YAMAHA ELECTRONIK EUROPA G.m.b.H. SIEMENSSTR. 22-34, 25462 RELINGEN BEI HAMBURG, F.R. OF GERMANY
YAMAHA ELECTRONIQUE FRANCE S.A. RUE AMBROISE CROIZAT BP70 CROISSY-BEAUBOURG 77312 MARNE-LA-VALLEE CEDEX02, FRANCE
YAMAHA ELECTRONICS (UK) LTD. YAMAHA HOUSE, 200 RICKMANSWORTH ROAD WATTFORD, HERTS WD1 7JS, ENGLAND
YAMAHA SCANDINAVIA A.B. J A WETTERGRENS GATA 1, BOX 30053, 400 43 VÄSTRA FRÖLUNDA, SWEDEN
YAMAHA MUSIC AUSTRALIA PTY, LTD. 17-33 MARKET ST., SOUTH MELBOURNE, 3205 VIC., AUSTRALIA

YAMAHA CORPORATION
3139 246 12064 Printed in China